

Operation and installation manual

KNX DMX Gateway 544

(Art. # 5358)

Gateway between KNX and DMX512

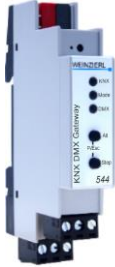

KNX DMX Gateway 544

Application area

The KNX DMX Gateway 544 is a compact gateway between KNX and DMX512 (protocol for lighting control) with up to 64 freely configurable channels.

The device enables simple integration of DMX devices into KNX systems and can act as a DMX master or slave.

In master mode, up to 64 dimming channels or up to 8 RGB/RGBW channels are available. Several subsets of DMX512 addresses can be assigned to each dimming channel and each color of an RGB/RGBW channel.

The dimming channels enable switching /rel./abs. Dimming of one or more DMX luminaires via KNX. The RGB/RGBW channels enable control of RGB/RGBW-capable DMX luminaires, e.g. each RGB color and each HSV attribute can be individually controlled via KNX.

Each channel can be linked to up to 8 scenes. In addition, 4 sequencers are available in the Gateway to perform more complex tasks.

In slave mode KNX actuators can be controlled by DMX. For example, the room lighting, which is part of the KNX installation, can be controlled via a DMX lighting control panel. Up to 64 DMX512 addresses can be individually evaluated and sent to KNX. Dimming value, switching with switching threshold and RGB value are available for interpretation.

Two push buttons and three LEDs allow a local operation and a visualization of the device state.

In addition to the output and input channels the device includes 16 independent functions for logic or timer control.

1. Installation and connection

The KNX DMX Gateway 544 is designed for installation on a DIN rail (35 mm) with a width of 1 units (18 mm). An installation-friendly design with pluggable screw terminals helps to reduce the cost of commissioning. It features the following controls and displays:

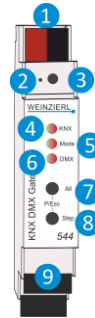

- 1 KNX bus connector
- 2 Programming LED
- 3 Button f. programming mode
- 4 LED KNX (multicolor)
- 5 LED Mode (multicolor)
- 6 LED DMX (multicolor)
- 7 Button All
- 8 Button Step
- 9 Pluggable screw terminals



The device can not work without bus power.

A. KNX Programming mode

The KNX programming mode is activated/deactivated either by pressing the flushed KNX programming button **3** or by simultaneously pressing the buttons **7** and **8**. Accessing the programming mode via the device front buttons can be enabled / disabled via the ETS® by changing the value of *Prog. mode* on device front.

When the programming mode is active, the programming LED **2** and LED Mode **5** light red.

B. Manual operation and status display

The LED Mode **5** lights up or flashes if the device is successfully powered by the KNX bus.

Pressing button All **7** for a long time switches to manual operation for all DMX channels. This is indicated by cyclic, single flashing of the LED Mode **5** in orange. In this mode all 512 DMX addresses are controlled simultaneously. They can be switched on by pressing button All **7** and switched off by pressing button Step **8** short. In addition, they can be dimmed brighter with long button press on **7** and darker with long button press on **8**.

By pressing button Step **8** for a long time the manual operation for individual DMX channels is activated. This is indicated by cyclic, double flashing of the LED Mode **5** in orange. In this mode the DMX addresses are controlled individually. By pressing short on button All **7** or button Step **8** each channel is activated step by step, by pressing button **7** or **8** for a long time automatic activation is started in the respective direction. Short button press on **7** and **8** stops the automatic activation.

LED KNX **4** is used to display the status of KNX communication. It flashes during transmission and reception of telegrams.

LED DMX **6** is used for status display of DMX communication, it lights up when DMX communication is activated.

Summary of the states of LED Mode 5:

LED Status	Meaning
LED lights green	Device is working in standard operation mode.
LED lights red	Programming mode is active.
LED flashes 1x orange	Programming mode is not active. Manual operation is active, switching/dimming of all 512 DMX channels simultaneously possible
LED flashes 2x orange	Programming mode is not active. Manual operation is active, switching of the individual DMX channels possible
LED flashes red	Programming mode is not active. Manual operation is not active. The device is not properly loaded, e.g. after an interrupted ETS download.
LED flashes green	The device is currently loaded by the ETS.

2. Reset to factory device settings

It is possible to reset the device to its factory settings:

- Disconnect the KNX Bus connector 1 from device
- Press the KNX programming button 3 and keep it pressed down
- Reconnect the KNX Bus connector 1 of device
- Keep the KNX programming button 3 pressed for at least another 6 seconds
- A short flashing of all LEDs (2 4 5 6) visualizes the successful reset of the device to factory default settings.

3. Wiring scheme

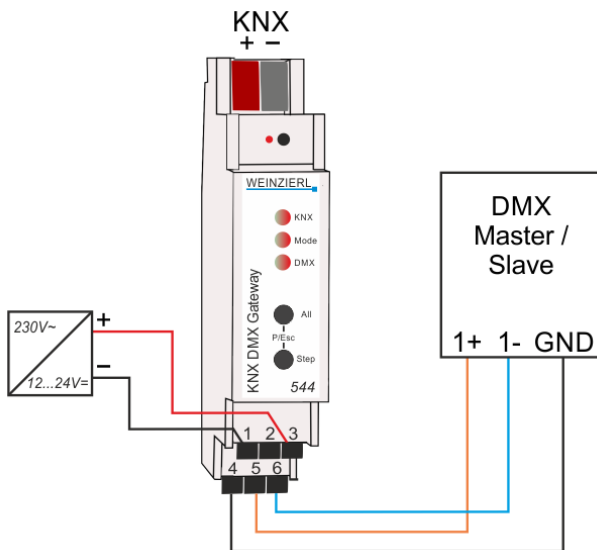

A. Pluggable screw terminals

The upper terminal is used to connect the supply voltage 12 ... 24 V₌₌, the lower terminal to connect DMX:

-	-	+
-	1+	1-

B. Pin assignment

Connection	Icon	Description
1	-	Ground connection for supply voltage
2	-	Ground connection for supply voltage
3	+	Positive connection for Supply voltage 12 ... 24 V ₌₌
4	-	Ground connection for Modbus (connected to connection 1 and connection 2)
5	1+	Data line 1+ for DMX
6	1-	Data line 1- for DMX
KNX	+	Positive connection for KNX Bus
KNX	-	Ground connection for KNX Bus

The transmission line must be terminated at the last receiver of the DMX512 transmission path with a 120 Ohm / 0.25 W resistor. This resistor must be inserted directly between the two signal lines before the input of the last receive circuit.

Only shielded cables with twisted wires should be used for DMX.

4. ETS database

The ETS database (for ETS 5) can be downloaded from the product website of the KNX DMX Gateway 544 (www.weinzierl.de) or from the ETS online catalogue.

ETS parameter dialog

The following pages and parameters are visible in the ETS.

A. Description

This page shows the device description and the associated wiring scheme.

--- KNX DMX Gateway 544 > Description

Description

General settings KNX DMX Gateway 544
Gateway between KNX and DMX512 with up to 64 dimming/monitoring channels WEINZIERL

DMX settings

Logic / Timer

The KNX DMX Gateway 544 is a compact gateway between KNX and DMX with up to 64 freely configurable channels.

The device enables easy integration of DMX devices into KNX installations and can act as a DMX master or slave.

In master mode, up to 64 dimmer channels or up to 8 RGB/RGBW channels are available. Several subsets of DMX512 addresses can be assigned to each dimmer channel and each color of an RGB/RGBW channel.

The dimmer channels enable switching/rel./abs. dimming of one or more DMX devices via KNX. The RGB/RGBW channels enable control of RGB/RGBW capable DMX devices, e.g. each RGB color and each HSV attribute can be individually controlled via KNX.

Each channel can be linked to up to 8 scenes. In addition, 4 sequencers are available in the gateway to perform more complex tasks.

In slave mode, up to 64 DMX512 addresses can be individually monitored and sent to KNX.

Two push buttons and three LEDs allow a local operation and a visualization of the device state.

In addition to the gateway channels the device includes 16 independent functions for logic or timer control.

Wiring scheme:

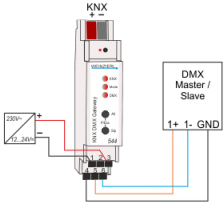

Please consult device data sheet and manual for further information.

Contact:

Weinzierl Engineering GmbH
Achate 3
84508 Burgkirchen / Alz
Germany
www.weinzierl.de
info@weinzierl.de

B. General settings

--- KNX DMX Gateway 544 > General settings

Description Device name: KNX DMX Gateway 544

General settings Send delay after bus power return: 5 s

DMX settings Prog. mode on device front: Disabled Enabled

Logic / Timer Manual operation on device: Enabled with time limit 10 min

Heartbeat: Disabled Enabled

Cycle time: 5 min

KNX settings Telegram rate limitation: 1.0 s

Device name (30 characters)

An arbitrary name can be assigned for the KNX DMX Gateway 544. The device name should be meaningful, e.g. „Living Room“. This helps the clarity of the ETS project.

Send delay after bus power return

A send delay of telegrams after the return of the bus voltage can be set via this parameter. In this case, telegrams from the device are sent to the KNX bus in a delayed manner by the set time. This results in a reduction of the bus load at a bus power return. Other functions such as receiving telegrams of switching operations of the actuator are not affected by this parameter.

Prog. mode on device front

In addition to the normal programming button **3** the device allows activating the programming mode on the device front without opening the switchboard cover. The programming mode can be activated and deactivated via pressing simultaneously both buttons **7** and **8**.

This feature can be enabled and disabled via the parameter „Prog. mode on device front“. The recessed programming button

3 (next to the Programming LED **2**) is always enabled and not influenced by this parameter.

Manual operation on device

This parameter is used to configure the manual operation on the device. The manual operation mode can be disabled or activated (with or without time limitation). The time limit defines the duration until the automatic return from the manual operation mode back into the normal operating mode.

The device is in normal operating mode when the manual control is not active. In the manual operating mode, received switching telegrams are ignored. When the manual operation mode is terminated (after expiry of the time limit or manually), the last state of the outputs remains, until a new switching telegram is received again.

The following options are selectable:

- Disabled
- Enabled with time limit 1 min
- Enabled with time limit 10 min
- Enabled with time limit 30 min
- Enabled without time limit

Heartbeat

Cyclic sending of values to the KNX-Bus, to indicate that the device is operational. For the cycle time values between 1 min and 24h are selectable.

Group object	Type KNX	Size	Direction
GO 1 Heartbeat - Trigger	1.001	1 Bit	To KNX

Time telegram limitation

Here the telegram rate limitation can be activated and the time between the telegrams can be configured. Times between 0.1 sec. and 1.0 sec. can be selected.

i *The telegram rate limitation only occurs with increased transmission of own telegrams.*

Operating mode DMX Master

In Master mode, up to 64 independent dimmer channels or up to 8 independent RGB/RGBW channels are available. In addition, up to 4 sequencers are available device wide in this operating mode in order to carry out more complex tasks.

C. DMX settings

KNX Gateway: DMX Master

Dimmer channels

Up to 64 dimmer channels can be activated.

RGB channels

Up to 8 RGB/RGBW channels can be activated.

Sequencer channels

Up to 4 sequencer channels can be activated.

Time mark before break

BREAK to BREAK Time

Time mark between slots

MARK time between slots

DMX frame size

This parameter specifies up to which DMX address is sent:

- Automatic
The DMX telegram length is determined from the settings in the channels.
- Fixed
The DMX addresses up to this value are sent per frame.

Start DMX after restart of device

This parameter can be used to determine whether the transmission of DMX telegrams is activated or deactivated after a device restart. If this parameter is set to disabled, the transmission can only be started via object 6:

Group object	Type KNX	Size	Direction
GO 6 DMX communication -Enable/Disable	1.001	1 Bit	From KNX

Enable DMX after disabled by object

This parameter can be used to determine how the sending of DMX telegrams can be reactivated after it has been disabled via object 6. The following can be selected:

- Only by object
- After delay time
A parameter for entering the delay time appears.

Disable DMX after enabled by object

This parameter can be used to determine how the sending of DMX telegrams can be deactivated again after it has been enabled via object 6. The following can be selected:

- Only by object
- After delay time
A parameter for entering the delay time appears.

Diagnostic object

With this parameter the following object becomes visible to visualize the state of the DMX communication:

Group object	Type KNX	Size	Direction
GO 4 Diagnostic - DMX communication	1.001	1 Bit	To KNX

This parameter can also be used to set whether an ON or OFF telegram is sent when DMX communication is present.

The following is a description of the 1st dimmer or RGB/RGBW channel and the 1st sequencer, the remaining channels work analog.

A. Dimmer 1: General

Name (30 characters)

An arbitrary name can be assigned for the channel. However, this should be clear and meaningful, this makes it easier to work with the associated group objects, because the given name is displayed there as a label. If no name is assigned, the group objects are named "Dimmer 1: ...".

Send state

If activated, the following objects are available for sending states:

Group object	Type KNX	Size	Direction
GO 16 Dimmer 1: Dimming output - State on/off	1.001	1 Bit	To KNX
GO 17 Dimmer 1: Dimming output -State value	5.001	1 Byte	To KNX

This parameter also defines the behavior of the state objects:

- Disabled
State objects are deactivated and not displayed.
- Only on read
State objects send only on request.
- On change
The switch object sends an OFF telegram once if the output value falls below the switch-on dimming value, an ON telegram if it exceeds the switch-on dimming value.

- Cyclic and on change
State objects send cyclically and on value change

ON when dimming value over

This parameter determines which dimming value must be exceeded for an ON telegram to be sent via object 16.

Time for cyclic state

With this parameter, the cycle time can be set, when "Cyclic and on change" is selected for sending state.

Behavior on bus power failure

The behavior of the output in the event of bus power failure can be configured here.

The following options are selectable:

- No reaction
- Dim to value
A parameter for adjusting the value appears.

Behavior after bus power return

Here the behavior of the output after bus power return can be configured. This behavior will be set after every device restart (e.g. also on restart after ETS download).

The following options are selectable:

- No reaction
- Dim to value
A parameter for adjusting the value appears.
- State like before bus power failure

Scene function

The scene function can be activated or deactivated here; it is only available in the "Dimmer" operating mode. If this function is activated, the parameter page "Dimmer x: Scene function" appears for further configuration of scenes 1-8. The further functionality is explained in section C.

DMX channels included

The DMX channels used by the channel can be determined here. The following inputs are supported:

- Single channels: The number of the desired channel is entered.
- Ranges: Start and end channel are entered separately with a dash, e.g. 1-100.
- Areas with omission: Start and end channel are entered separately with a dash, the index must be written separated by a colon behind the end channel, e.g. 1-99:2. In this example, each odd channel is controlled up to 99, i.e. channels 1, 3, 5, ..., 97, 99.

Entries can be separated by semicolon or comma, e.g.:

- 1;7;23: The DMX channels 1, 7 and 23 are used.
- 2,5-7,23: The DMX channels 2, 5, 6, 7 and 23 are used.
- 1-9:2;58,100-512: DMX channels 1, 3, 5, 7, 9, 58 are used, as well as channels 100-512.

Spaces can be used for better readability, but they reduce the space available for entries.

i DMX channels may only be assigned to a single dimmer channel at a time, group functions must be implemented using the same group addresses.

DMX channels excluded

With this parameter, areas of the used DMX channels can be cut out again. The valid entries of the cut areas are the same as those of the used channels.

Example:

- DMX channels included: 1-100
- DMX channels excluded: 2-10:2;92-100:2

In the ranges 1-10 and 92-100 only the odd DMX channels are used, in the remaining range 11-91 all channels.

B. Dimmer 1: Dimmer

Object Dimming on/off

The screenshot shows the configuration page for "Dimmer 1: Dimmer". The "Object Dimming on/off" section is active, showing the following settings:

- Object Dimming on/off: Enabled
- Behavior on ON telegram (when dimmer is off): Dimm to fix value
- Behavior on ON telegram (when dimmer is on): Dimm to fix value
- Dimming value on ON telegram: 100
- Fade time on ON telegram (related to 100%): 00:00:00
- Behavior on OFF telegram: Dimm to fix value
- Dimming value on OFF telegram: 0
- Behavior on 2nd OFF telegram: No reaction
- Fade time on OFF telegram (related to 100%): 00:00:00
- Day/night switching: Switch on day/night telegram
- Dimming value on ON telegram (night): 50
- Dimming value on OFF telegram (night): 0
- Fade time for day/night switching (related to 100%): 00:00:04
- Object Dimming rel.: Disabled
- Object Dimming value: Disabled
- Object RGB value: Disabled

For switching the dimmers, the following object is available, if it has been activated via parameters:

Group object	Type KNX	Size	Direction
GO 11 Dimmer 1: Dimming on/off - Switch	1.001	1 Bit	From KNX

Behavior on ON telegram (when dimmer is off)

If the dimmer is switched off, this parameter can be used to configure the behavior when switching on via object 11.

It is available:

- No reaction
- Dim to fix value
- Dim to last value before switching off

Behavior on ON telegram (when dimmer is on)

If the dimmer is already switched on, this parameter can be used to configure the behavior for a new ON telegram via object 11.

It is available:

- No reaction
- Dim to fix value
- Dim to fix value if higher than actual

Dimming value on ON telegram

This value is activated by ON telegram via object 11 with suitable parameterization.

Fade time on ON telegram

This fade time is active when an ON telegram is received. The period refers to a complete dimming process of 0-100%.

Behavior on OFF telegram

This parameter describes the behavior of the dimmer when an OFF telegram is sent via object 11.

It is available:

- No reaction
- Dim to fix value

Dimming value on OFF telegram

This value is activated by OFF telegram via object 11 with suitable parameterization.

Behavior on 2. OFF telegram

This parameter describes the behavior of the dimmer when a 2. OFF telegram is received via object 11.

It is available:

- No reaction
- Switch off

The 2. OFF telegram must follow the 1. OFF telegram within 1 second in order to be evaluated. If the current brightness is equal to or lower than the parameterized brightness for OFF telegram, the device is already switched off by the 1. OFF telegram.

Fade time on OFF telegram

This fade time is active when an OFF telegram is received. The period refers to a complete dimming process of 0-100%.

Day/night switching

When using this function, the following objects are visible for switching between day/night mode:

Group object	Type KNX	Size	Direction
GO 15 Dimmer 1: Day/Night - Switch	1.001	1 Bit	From KNX

Day mode is triggered with an ON telegram on object 15, night mode with an OFF telegram. After a restart, the device is in day mode.

In addition, it can be determined when the values become active after receiving a telegram on these objects, it is available:

- Disabled
- Switch on day/night telegram
Immediately after reception of day/night switching, it is dimmed to the active value according to the last switch-on/switch-off received via object 11.
- Switch on next on/off telegram
The currently active value is not used until the next switch on/off telegram via object 11.

There is a separate switch-on and switch-off value for night mode in the parameters, in day mode the always visible values are used.

Dimming value on ON telegram (night)

If the dimmer is in night mode, this value is activated by ON telegram via object 11 and suitable parameterization.

Dimming value on OFF telegram (night)

If the dimmer is in night mode, this value is activated by OFF telegram via object 11 and suitable parameterization.

Fade time for day/night switching

This fade time is only active if switching on day/night telegram is used. If switching on next on/off telegram is used, the regular fade time of the respective on or off telegram is active. The period refers to a complete dimming process of 0-100%.

Object Dimming rel.

--- KNX DMX Gateway 544 > Channel 1: Dimmer > Dimmer 1: Dimmer

Description	Object Dimming on/off <input type="radio"/> Disabled <input type="radio"/> Enabled
General settings	Object Dimming rel. <input type="radio"/> Disabled <input checked="" type="radio"/> Enabled
DMX settings	Minimal dimming value while dimming with object 0 %
Logic / Timer	Maximal dimming value while dimming with object 100 %
Channel 1: Dimmer	Fade time while dimming brighter with object (related to 100%) 00:00:04 h:mm:ss
Dimmer 1: General	Fade time while dimming darker with object (related to 100%) 00:00:04 h:mm:ss
Dimmer 1: Dimmer	Object Dimming value <input checked="" type="radio"/> Disabled <input type="radio"/> Enabled
	Object RGB value <input checked="" type="radio"/> Disabled <input type="radio"/> Enabled

The following objects are available for dimming using relative dimming commands, if activated via parameters:

Group object	Type KNX	Size	Direction
GO 12 Dimmer 1: Dimming rel. - Brighter/Darker	3.007	4 Bit	From KNX

Minimal dimming value while dimming with object

This parameter can be used to set which minimum dimming value can be achieved via relative dimming. If the current dimming value is below the minimum value, the brightness cannot be reduced via object 12.

Maximal dimming value while dimming with object

This parameter can be used to set which maximum dimming value can be achieved via relative dimming. If the current dimming value is above the maximum value, the brightness cannot be increased via object 12.

Fade time while dimming brighter with object

This fade time is active when the brightness is increased by relative dimming with object 12. The period refers to a complete dimming process of 0-100%.

Fade time while dimming darker with object

This fade time is active when the brightness is decreased by relative dimming with object 12. The period refers to a complete dimming process of 0-100%.

Object Dimming value

The following objects are used to control the dimmer via dimming value if they have been activated via parameters:

Group object	Type KNX	Size	Direction
GO 13 Dimmer 1: Dimming abs. - Set value	5.001	1 Byte	From KNX

Minimal dimming value for changing dimming value with object

This parameter can be used to configure which minimum dimming value can be reached via object 13. If a value below the minimum value is received, the dimmer is controlled with the minimum value. If a value >0% is set here, the following parameter is also visible:

Switch off dimmer with telegram value 0%

Here can be selected whether the dimmer is switched off when a value of 0% is received.

Maximal dimming value for changing dimming value with object

This parameter can be used to configure which maximum dimming value can be reached via object 13. If a value above the maximum value is received, the dimmer is controlled with the maximum value.

Fade time while dimming brighter with object

This fade time is active when the brightness is increased by value via object 13. The period refers to a complete dimming process of 0-100%.

Fade time while dimming darker with object

This fade time is active when the brightness is decreased by value via object 13. The period refers to a complete dimming process of 0-100%.

Object RGB value

To control the dimmer via RGB color value, the following objects are available, if activated via parameter:

Group object	Type KNX	Size	Direction
GO 14 Dimmer 1: RGB color value - Set value	232.600	3 Byte	From KNX

RGB value usage

Here it is set how a received RGB color value is to be processed:

- Use red part
The 1. byte of the RGB value (red) is used to control the brightness of the dimmer.
- Use green part
The 2. byte of the RGB value (green) is used to control the brightness of the dimmer.
- Use blue part
The 3. byte of the RGB value (blue) is used to control the brightness of the dimmer.
- Use white (min. value of red, green, blue)
The smallest value of the 3 bytes is used to control the brightness of the dimmer.
- Use brightness (max. value of red, green, blue)
The largest value of the 3 bytes is used to control the brightness of the dimmer.

Minimal value for changing color by object

This parameter can be used to configure which minimum dimming value can be set via object 14. If a value below the minimum value is received, the dimmer is controlled with the minimal value.

Maximal value for changing color by object

This parameter can be used to configure which maximum dimming value can be set via object 14. If a value above the maximum value is received, the dimmer is controlled with the maximum value.

Fade time while dimming brighter with object

This dimming time is active when the brightness is increased by values received via object 14. The time period refers to a complete dimming process of 0-100%.

Fade time while dimming darker with object

This dimming time is active when the brightness is decreased by values received via object 14. The time period refers to a complete dimming process of 0-100%.

C. Dimmer 1: Scene function

If the scene function is activated, the following group object appears:

Group object	Type KNX	Size	Direction
GO 18 Dimmer 1: Scene - Activ./Lrn.	18.001	1 Byte	From KNX

Fade time on activation of scene

Here the period can be set in which the received scene is dimmed to. The period refers to a complete dimming process of 0-100%.

Scene 1-8

These parameters can be used to configure the reaction of the channel when the respective scene is received.

It is available:

- No reaction
- Dimming value
The output is switched to the set dimming value if the scene of the corresponding number was received.
- Learnable
With the help of a scene control telegram, the current state at the output for the respective scene can be saved here. Thus the scene can be adapted by the user without ETS download.

Number

With this parameter any scene number between 1 and 64 can be assigned to the scene. No scene numbers may be assigned twice.

A. RGB 1: General

The screenshot shows the configuration page for 'RGB 1: General' in a KNX DMX Gateway 544. The interface is divided into several sections:

- Description:** Name: RGB 1
- General settings:** Send state: Cyclic and on change
- DMX settings:** Time for cyclic state: 6 h
- Logic / Timer:** State objects for on/off/RGB color (3 bytes): Disabled (selected), Enabled
- Channel 1: RGB:** State objects for single colors: Disabled (selected), Enabled
- RGB 1: General:**
 - State objects for HSV: Disabled (selected), Enabled
 - Behavior on bus power loss: No reaction (selected), Switch to color
 - Color: #FFFFFF
 - Behavior after bus power return: Switch to color (selected), State like before bus power failure
 - Color: #000000
 - RGBW mode (brightness of white increases with lower saturation): No influence of white on RGB
 - Scene function: Disabled (selected), Enabled
 - Object RGB combined (3 bytes): Disabled (selected), Enabled
 - Fade time on changing color: 00:00:00 h:mm:ss
 - Objects colors separate: Disabled (selected), Enabled
 - Objects color/saturation/brightness: Disabled (selected), Enabled
 - Red: DMX channels included
 - Green: DMX channels included
 - Blue: DMX channels included
 - White: DMX channels included
 - Red: DMX channels excluded
 - Green: DMX channels excluded
 - Blue: DMX channels excluded
 - White: DMX channels excluded

Valid input:
 - Single channels: 1,2,3 or 1,2,3
 - Range: 1-9
 - Range with index: 1-93
 - Mixed: 1:2-2599-111:2

Name (30 characters)

An arbitrary name can be assigned for the channel. However, this should be clear and meaningful, this makes it easier to work with the associated group objects, because the given name is displayed there as a label. If no name is assigned, the group objects are named "RGB 1: ...".

Send state

This parameter defines the behavior of the state objects:

- Disabled
State objects are deactivated and not displayed.
- Only on read
State objects send only on request.
- On change
State objects send on value change.
- Cyclic and on change
State objects send cyclically and on value change.

Time for cyclic state

With this parameter, the cycle time can be set, when "Cyclic and on change" is selected for sending state.

State objects for on/off/RGB color (3 byte)

Activates the following state objects:

Group object	Type KNX	Size	Direction
GO 31 RGB 1: RGB output - State on/off	1.001	1 Bit	To KNX
GO 32 RGB 1: RGB output- State color	232.600	3 Byte	To KNX

If sending on value change is activated and all 3 colors change to value 0, the state object On/Off sends an OFF telegram, if at least one of the 3 colors changes to a value greater than 0, the object sends an ON telegram.

If sending on value change is activated and at least one of the 3 colors changes, the state object color sends new RGB values with a time interval of at least 1 second.

State objects for single colors

Activates the following state objects:

Group object	Type KNX	Size	Direction
GO 33 RGB 1: Red output - State value	5.001	1 Byte	To KNX
GO 34 RGB 1: Green output - State value	5.001	1 Byte	To KNX
GO 35 RGB 1: Blue output - State value	5.001	1 Byte	To KNX

In RGBW configuration the following object is also available:

Group object	Type KNX	Size	Direction
GO 36 RGB 1: White output - State value	5.001	1 Byte	To KNX

If sending on value change is activated, the state objects transmit with a time interval of at least 1 second if the color assigned to the object has changed by at least 1% or if a dimming process has been completed.

State objects for HSV

Activates the following state objects:

Group object	Type KNX	Size	Direction
GO 37 RGB 1: HSV color angle - State angle	5.003	1 Byte	To KNX
GO 38 RGB 1: HSV saturation - State value	5.001	1 Byte	To KNX
GO 39 RGB 1: HSV brightness - State value	5.001	1 Byte	To KNX

If sending on value change is activated, the state objects transmit with a time interval of at least 1 second if the color attribute assigned to the object has changed by at least 1% or if a dimming process has been completed.

The behavior of the output in the event of bus power failure can be configured here.

The following options are selectable:

- No reaction
- Switch to color
A parameter for adjusting the color appears.

Behavior after bus power return

Here the behavior of the output after bus power return can be configured. This behavior will be set after every device restart (e.g. also on restart after ETS download).

The following options are selectable:

- Switch to color
A parameter for adjusting the color appears.
- State like before bus power failure

RGBW mode

In RGBW mode, the saturation calculated from the current RGB value determines the value for white: Minimum saturation leads to the maximum value of white, and vice versa. This parameter can also be used to determine whether the output values for red, green and blue should be scaled depending on the current white value:

- No influence of white on RGB:
White has no influence on RGB, e.g. with an RGB color value of white (#FFFFFF) all output values are at maximum.
- Dim RGB on higher brightness of white:
In this setting the output values of red, green and blue are scaled with the saturation, e.g. with an internal RGB color value of white (#FFFFFF) the output values of red, green and blue are set to minimum, the output value of white is set to maximum..

The status objects behave the same in both RGBW operating modes, only the visible output of RGB changes.

Object RGB combined (3 Byte)

Enables the function block for controlling the dimmer via the following object:

Group object	Type KNX	Size	Direction
GO 11 RGB 1: RGB - Set value	232.600	3 Byte	From KNX

To set the fade time, the following parameter becomes also visible:

Fade time on changing color

The period is related to a complete dimming process of 0-100%.

Objects colors separate

Enables the function blocks for controlling the 3 single colors red, green and blue. For each color, a parameter block is displayed, which is explained in section B.

Objects color/saturation/brightness

Enables the function blocks for controlling the dimmer via the 3 attributes color, saturation and brightness. For each attributes, a parameter block is displayed, which is explained in sections C, D and E.

Scene function

The scene function can be activated or deactivated here. If this function is activated, a parameter page appears for further configuration of scenes 1-8. The further functionality is explained in section H.

Red: DMX channels included

Green: DMX channels included

Blue: DMX channels included

When using an RGBW mode, also:

White: DMX channels included

The DMX channels used for the respective color can be determined here. The following inputs are supported:

- Single channels: The number of the desired channel is entered.
- Ranges: Start and end channel are entered separately with a dash, e.g. `1-100`.
- Areas with omission: Start and end channel are entered separately with a dash, the index must be written separated by a colon behind the end channel, e.g. `1-99:2`. In this example, each odd channel is controlled up to 99, i.e. channels 1, 3, 5, ..., 97, 99.

Entries can be separated by semicolon or comma, e.g.:

- `1;7;23`: The DMX channels 1, 7 and 23 are used.
- `2,5-7,23`: The DMX channels 2, 5, 6, 7 and 23 are used.
- `1-9:2;58;100-512`: DMX channels 1, 3, 5, 7, 9, 58 are used, as well as channels 100-512.

Spaces can be used for better readability, but they reduce the space available for entries.



DMX channels may only be assigned to a single dimmer channel at a time, group functions must be implemented using the same group addresses.

Red: DMX channels excluded

Green: DMX channels excluded

Blue: DMX channels excluded

When using an RGBW mode, also:

White: DMX channels excluded

With this parameter, areas of the DMX channels used can be cut out again. The valid entries of the cut areas are the same as those of the used channels.

Example:

- Red: DMX channels included: `1-100`
- Red: DMX channels excluded: `2-10:2;92-100:2`

In the ranges 1-10 and 92-100 only the odd DMX channels are used for red, in the remaining range 11-91 all channels.

B. RGB 1: Red
RGB 1: Green
RGB 1: Blue

Each of the 3 individual colors red, green and blue can be controlled independently with on/off telegram, relative dimming and dimming value. The following parameters and objects are available for each color:

Object color Red on/off

Object color Green on/off

Object color Blue on/off

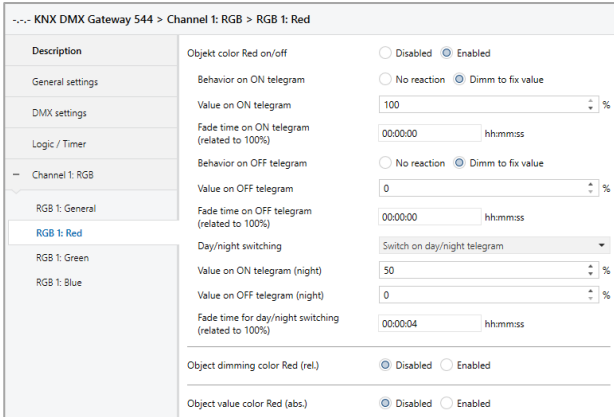

For switching the single colors, the following objects are available, if they have been activated via parameters:

Group object	Type KNX	Size	Direction
GO 12 RGB 1: Red on/off - Switch	1.001	1 Bit	From KNX
GO 15 RGB 1: Green on/off - Switch	1.001	1 Bit	From KNX
GO 18 RGB 1: Blue on/off - Switch	1.001	1 Bit	From KNX

Behavior on ON telegram

This parameter can be used to configure the behavior when switching on via the respective object.

It is available:

- No reaction
- Dim to fix value

Value on ON telegram

With suitable parameterization this value is activated on ON telegram via the respective object.

Fade time on ON telegram

This fade time is active when an ON telegram is received. The period is related to a complete dimming process of 0-100%.

Behavior on OFF telegram

This parameter describes the behavior of the dimmer when an OFF telegram is received via the respective object.

It is available:

- No reaction
- Dim to fix value

Value on OFF telegram

With suitable parameterization this value is activated on OFF telegram via the respective object.

Fade time on OFF telegram

This fade time is active when an OFF telegram is received. The period is related to a complete dimming process of 0-100%.

Day/night switching

When using this function for at least one of the 3 colors, the following object is visible for switching between day/night mode:

Group object	Type KNX	Size	Direction
GO 30 RGB 1: Day/Night - Switch	1.001	1 Bit	From KNX

Day mode is triggered with an ON telegram on the object, night mode with an OFF telegram. After a restart, the device is in day mode.

i Telegrams on object 30 affect all activated day/night switches of the RGB channel.

In addition, it can be determined when the values become active after receiving a telegram on this object, it is available:

- Disabled
- Switch on day/night telegram
Immediately after reception of day/night switching, it is dimmed to the active value according to the last received switch-on/switch-off via object 12, 15 or 18.
- Switch on next on/off telegram
The currently active value is not used until the next switch on/off telegram via object 12, 15 or 18.

There is a separate switch-on and switch-off value for night mode in the parameters, in day mode the always visible values are used.

Value on ON telegram (night)

If the dimmer is in night mode, this value is activated by ON telegram via object 12, 15 or 18 and appropriate parameterization.

Value on OFF telegram (night)

If the dimmer is in night mode, this value is activated by OFF telegram via object 12, 15 or 18 and appropriate parameterization.

Fade time for day/night switching

This fade time is only active if switching on day/night telegram is used. If switching on next on/off telegram is used, the regular fade time of the respective on or off telegram is active. The period refers to a complete dimming process of 0-100%.

Object dimming color Red (rel.)

Object dimming color Green (rel.)

Object dimming color Blue (rel.)

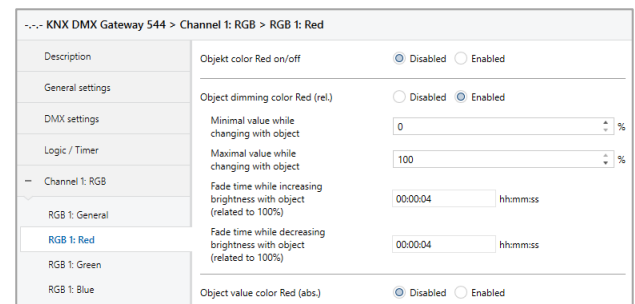

The following objects are available for dimming the 3 colors using relative dimming commands, if they have been activated via parameters:

Group object	Type KNX	Size	Direction
GO 13 RGB 1: Red dimming rel. - Brighter/Darker	3.007	4 Bit	From KNX
GO 16 RGB 1: Green dimming rel. - Brighter/Darker	3.007	4 Bit	From KNX
GO 19 RGB 1: Blue dimming rel. - Brighter/Darker	3.007	4 Bit	From KNX

Minimal value while changing with object

This parameter can be used to set which minimum value can be reached via relative dimming. If the current value is below the minimum value, the brightness cannot be reduced via object 13, 16 or 19.

Maximal value while changing with object

This parameter can be used to set which maximum value can be reached via relative dimming. If the current value is above the maximum value, the brightness cannot be increased via object 13, 16 or 19.

Fade time while increasing brightness with object

This fade time is active when the brightness is increased via relative dimming with object 13, 16 or 19. The period refers to a complete dimming process of 0-100%

Fade time while decreasing brightness with object

This fade time is active when the brightness is decreased via relative dimming with object 13, 16 or 19. The period refers to a complete dimming process of 0-100%.

Object value color Red (abs.)

Object value color Green (abs.)

Object value color Blue (abs.)

The following objects are used to control the 3 colors via the dimming value if they have been activated via parameters:

Group object	Type KNX	Size	Direction
GO 14 RGB 1: Red dimming abs. - Set value	5.001	1 Byte	From KNX
GO 17 RGB 1: Green dimming abs. - Set value	5.001	1 Byte	From KNX
GO 20 RGB 1: Blue dimming abs. - Set value	5.001	1 Byte	From KNX

Minimal value while receiving by object

This parameter can be used to configure which minimum value can be reached via object 14, 17 or 20. If a value is received below the minimum value, the color is controlled with the minimum value. If a value >0% is set here, the following parameter is also visible:

Process value 0 by object

Here it is to select whether the color is switched off when a value of 0% is received.

Maximal value while changing with object

This parameter can be used to configure which maximum value can be reached via object 14, 17 or 20. If a value above the maximum value is received, the color is controlled with the maximum value.

Fade time while increasing brightness with object

This fade time is active when the brightness is increased by values received via object 14, 17 or 20. The period refers to a complete dimming process of 0-100%.

Fade time while decreasing brightness with object

This fade time is active when the brightness is decreased by values received via object 14, 17 or 20. The period refers to a complete dimming process of 0-100%.

C. RGB 1: Color

With this function block you can activate different colors via on/off telegrams, in addition there are objects for manipulating the color angle.

The color angle (hue) is an attribute of a color in the HSV space and assigns an angle in a color circle to each hue.

Object Color on/off

The following object is available for switching the dimmer, if it has been activated in the parameters:

Group object	Type KNX	Size	Direction
GO 21 RGB 1: Color on/off - Switch	1.001	1 Bit	From KNX

Behavior on ON telegram (when dimmer is off)

If the dimmer is switched off, this parameter can be used to configure the behavior when switching on via object 21.

It is available:

- No reaction
- Dim to fix color
- Dim to last color before switching off

Behavior on ON telegram (when dimmer is on)

If the dimmer is already switched on, this parameter can be used to configure the behavior for a new ON telegram via object 21.

It is available:

- No reaction
- Dim to fix color

Color on ON telegram

With suitable parameterization this color is activated by ON telegram via object 21.

Fade time on ON telegram

This fade time is active when an ON telegram is received. The period is related to a complete dimming process of 0-100%.

Behavior on OFF telegram

This parameter describes the behavior of the dimmer when an OFF telegram is received via object 21.

It is available:

- No reaction
- Dim to fix color

Color on OFF telegram

With suitable parameterization this color is activated by OFF telegram via object 21.

Fade time on OFF telegram

This fade time is active when an OFF telegram is received. The period is related to a complete dimming process of 0-100%.

Day/night switching

When using this function, the following object is visible for switching between day/night mode:

Group object	Type KNX	Size	Direction
GO 30 RGB 1: Day/Night - Switch	1.001	1 Bit	From KNX

Day mode is triggered with an ON telegram on the object, night mode with an OFF telegram. After a restart, the device is in day mode.



Telegrams on object 30 affect all activated day/night switches of the RGB channel.

In addition, it can be determined when the colors become active after receiving a telegram on this object, it is available:

- Disabled
- Switch on day/night telegram
Immediately after reception of day/night switching, it is dimmed to the active color according to the last switch-on/switch-off received via object 21.
- Switch on next on/off telegram
The currently active color is not used until the next switch on/off telegram via object 21.

There is a separate switch-on and switch-off color for night mode in the parameters, in day mode the always visible colors are used.

Color on ON telegram (night)

If the dimmer is in night mode, this color is activated by ON telegram via object 21 and appropriate parameterization.

Color on OFF telegram (night)

If the dimmer is in night mode, this color is activated by OFF telegram via object 21 and appropriate parameterization.

Fade time for day/night switching

This fade time is only active if switching on day/night telegram is used. If switching on next on/off telegram is used, the regular fade time of the respective on or off telegram is active. The period refers to a complete dimming process of 0-100%.

Object change Color Angle (rel.)

Description	Object Dimmer on/off	<input checked="" type="radio"/> Disabled <input type="radio"/> Enabled
General settings	Object change Color Angle (rel.)	<input type="radio"/> Disabled <input checked="" type="radio"/> Enabled
DMX settings	Fade time on changing color angle	00:00:04 h:mm:ss
Logic / Timer	Object change Color Angle (abs.)	<input checked="" type="radio"/> Disabled <input type="radio"/> Enabled

To change the color angle using relative dimming commands, the following object is available, if it has been activated via parameters:

Group object	Type KNX	Size	Direction
GO 22 RGB 1: Color angle adjusting rel. - Increase/Decrease	3.007	4 Bit	From KNX

Fade time for changing color angle

The time period is related to a complete dimming process of 0-360°.

Object change Color Angle (abs.)

Description	Object Dimmer on/off	<input type="radio"/> Disabled <input checked="" type="radio"/> Enabled
General settings	Object change Color Angle (rel.)	<input checked="" type="radio"/> Disabled <input type="radio"/> Enabled
DMX settings	Object change Color Angle (abs.)	<input type="radio"/> Disabled <input checked="" type="radio"/> Enabled
Logic / Timer	Fade time on changing color angle	00:00:04 h:mm:ss

To set the absolute value of the color angle, there is the following object, if it has been activated via parameters:

Group object	Type KNX	Size	Direction
GO 23 RGB 1: Color angle adjusting abs. - Set value	5.003	1 Byte	From KNX

Fade time for changing color angle

The time period is related to a complete dimming process of 0-360°.

D. RGB 1: Saturation

Saturation is an attribute of a color in the HSV space and represents the amount of white of a color.

Pure colors without white have a saturation of 100%, the lower the saturation, the more the color is perceived as white.

Object Saturation on/off

The following object is available for switching saturation, if it has been activated via parameters:

Group object	Type KNX	Size	Direction
GO 24 RGB 1: Saturation on/off - Switch	1.001	1 Bit	From KNX

Behavior on ON telegram

This parameter can be used to configure the behavior when switching on via the respective object.

It is available:

- No reaction
- Dim to fix value

Saturation on ON telegram

With suitable parameterization, this saturation is activated by an ON telegram via object 24.

Fade time on ON telegram

This fade time is active when an ON telegram is received. The period is related to a complete dimming process of 0-100%.

Behavior on OFF telegram

This parameter describes the behavior of the dimmer when an OFF telegram is received via object 24.

It is available:

- No reaction
- Dim to fix value

Saturation on OFF telegram

With suitable parameterization, this saturation is activated by an OFF telegram via object 24.

Fade time on OFF telegram

This fade time is active when an OFF telegram is received. The period is related to a complete dimming process of 0-100%.

Day/night switching

When using this function, the following object is visible for switching between day/night mode:

Group object	Type KNX	Size	Direction
GO 30 RGB 1: Day/Night - Switch	1.001	1 Bit	From KNX

Day mode is triggered with an ON telegram on the object, night mode with an OFF telegram. After a restart, the device is in day mode.



Telegrams on object 30 affect all activated day/night switches of the RGB channel.

In addition, it can be determined when the values become active after receiving a telegram on this object, it is available:

- Disabled
- Switch on day/night telegram
Immediately after reception of day/night switching, it is dimmed to the active value according to the last switch-on/switch-off received via object 24.
- Switch on next on/off telegram
The currently active value is not used until the next switch on/off telegram via object 24.

There is a separate switch-on and switch-off saturation for night mode in the parameters, in day mode the always visible saturation values are used.

Saturation on ON telegram (night)

If the dimmer is in night mode, this value is activated by ON telegram via object 24 and appropriate parameterization.

Saturation on OFF telegram (night)

If the dimmer is in night mode, this value is activated by OFF telegram via object 24 and appropriate parameterization.

Fade time for day/night switching

This fade time is only active if switching on day/night telegram is used. If switching on next on/off telegram is used, the regular fade time of the respective on or off telegram is active. The period refers to a complete dimming process of 0-100%.

Object change Saturation (rel.)

To change the saturation via relative dimming commands, there is the following object, if it has been activated via parameters:

Group object	Type KNX	Size	Direction
GO 25 RGB 1: Saturation adjusting rel. - Increase/ Decrease	3.007	4 Bit	From KNX

Minimal saturation while changing with object

This parameter can be used to set the minimum saturation that can be achieved by relative dimming. If the current saturation is below the minimum value, the saturation cannot be reduced via object 25.

Maximal saturation while changing with object

This parameter can be used to set the maximum saturation that can be achieved by relative dimming. If the current saturation is above the maximum value, the saturation cannot be increased via object 25.

Fade time while increasing saturation

This fade time is active when the saturation is increased by relative dimming with object 25. The time period refers to a complete dimming process of 0-100%.

Fade time while decreasing saturation

This fade time is active when the saturation is reduced by relative dimming with object 25. The period refers to a complete dimming process of 0-100%.

Object set value Saturation (abs.)

--- KNX DMX Gateway 544 > Channel 1: RGB > RGB 1: Saturation

Description	Object Saturation on/off	<input checked="" type="radio"/> Disabled <input type="radio"/> Enabled
General settings	Object change Saturation (rel.)	<input checked="" type="radio"/> Disabled <input type="radio"/> Enabled
DMX settings	Object set value Saturation (abs.)	<input type="radio"/> Disabled <input checked="" type="radio"/> Enabled
Logic / Timer	Minimal value for changing saturation by object	0 %
Channel 1: RGB	Maximal value for changing saturation by object	100 %
RGB 1: General	Fade time while increasing saturation (related to 100%)	00:00:04 h:mm:ss
RGB 1: Color	Fade time while decreasing saturation (related to 100%)	00:00:04 h:mm:ss
RGB 1: Saturation		
RGB 1: Brightness		

The following object is used to control saturation via dimming value, if it has been activated via parameters:

Group object	Type KNX	Size	Direction
GO 26 RGB 1: Saturation adjusting abs. - Set value	5.001	1 Byte	From KNX

Minimal value for changing saturation with object

This parameter can be used to configure which minimum saturation can be reached via object 26. If a value below the minimum value is received, the dimmer is controlled with the minimum value.

Minimal value for changing saturation with object

This parameter can be used to configure which maximum saturation can be reached via object 26. If a value below the maximum value is received, the dimmer is controlled with the maximum value.

Fade time while increasing saturation

This fade time is active when the saturation is increased by values received via object 26. The period is related to a complete dimming process of 0-100%.

Fade time while decreasing saturation

This fade time is active when the saturation is decreased by values received via object 26. The period is related to a complete dimming process of 0-100%.

E. RGB 1: Brightness

Brightness (value) is an attribute of a color in HSV space.

A brightness of 100% means that the color shines with maximal possible intensity, the lower the brightness, the less bright the color shines.

Object Brightness on/off

--- KNX DMX Gateway 544 > Channel 1: RGB > RGB 1: Brightness

Description	Object Brightness on/off	<input type="radio"/> Disabled <input checked="" type="radio"/> Enabled
General settings	Behavior on ON telegram (when brightness 0%)	Dimm to fix value
DMX settings	Behavior on ON telegram (when brightness >0%)	Dimm to fix value
Logic / Timer	Brightness on ON telegram	100 %
Channel 1: RGB	Fade time on ON telegram (related to 100%)	00:00:04 h:mm:ss
RGB 1: General	Behavior on OFF telegram	<input type="radio"/> No reaction <input checked="" type="radio"/> Dimm to fix value
RGB 1: Color	Brightness on OFF telegram	0 %
RGB 1: Saturation	Behavior on 2nd OFF telegram	<input checked="" type="radio"/> No reaction <input type="radio"/> Switch off
RGB 1: Brightness	Fade time on OFF telegram (related to 100%)	00:00:04 h:mm:ss
	Day/night switching	Switch on day/night telegram
	Brightness on ON telegram (night)	50 %
	Brightness on OFF telegram (night)	0 %
	Fade time for day/night switching (related to 100%)	00:00:04 h:mm:ss
	Object change Brightness (rel.)	<input checked="" type="radio"/> Disabled <input type="radio"/> Enabled
	Object set value Brightness (abs.)	<input checked="" type="radio"/> Disabled <input type="radio"/> Enabled

The following object is available for switching the brightness, if it has been activated via parameters:

Group object	Type KNX	Size	Direction
GO 27 RGB 1: Brightness on/off - Switch	1.001	1 Bit	From KNX

Behavior on ON telegram (when Brightness 0%)

If the current brightness is 0%, this parameter can be used to configure the behavior when switching on via object 27.

It is available:

- No reaction
- Dim to fix value
- Dim to last value before switching off

Behavior on ON telegram (when Brightness >0%)

If the current brightness is greater than 0%, this parameter can be used to configure the behavior for a new ON telegram via object 27.

It is available:

- No reaction
- Dim to fix value
- Dim to fix value if higher than actual

Brightness on ON telegram

This brightness is activated by ON telegram via object 27 with suitable parameterization.

Fade time on ON telegram

This fade time is active when an ON telegram is received. The period refers to a complete dimming process of 0-100%.

Behavior on OFF telegram

This parameter describes the behavior of the dimmer when an OFF telegram is received via object 27.

It is available:

- No reaction
- Dim to fix value

Brightness on OFF telegram

This brightness is activated by OFF telegram via object 27 with suitable parameterization.

Behavior on 2. OFF telegram

This parameter describes the behavior of the dimmer when a 2. OFF telegram is received via object 27.

It is available:

- No reaction
- Switch off

The 2. OFF telegram must follow the 1. OFF telegram within 1 second in order to be evaluated. If the current brightness is equal to or lower than the parameterized brightness for OFF telegram, the device is already switched off by the 1. OFF telegram.

Fade time on OFF telegram

This fade time is active when an OFF telegram is received. The period refers to a complete dimming process of 0-100%.

Day/night switching

When using this function, the following object is visible for switching between day/night mode:

Group object	Type KNX	Size	Direction
GO 30 RGB 1: Day/Night - Switch	1.001	1 Bit	From KNX

Day mode is triggered with an ON telegram on the object, night mode with an OFF telegram. After a restart, the device is in day mode.



Telegrams on object 30 affect all activated day/night switches of the RGB channel.

In addition, it can be determined when the values become active after receiving a telegram on this object, it is available:

- Disabled
- Switch on day/night telegram
Immediately after reception of day/night switching, it is dimmed to the active value according to the last switch-on/switch-off received via object 27.
- Switch on next on/off telegram
The currently active value is not used until the next switch on/off telegram via object 27.

There is a separate switch-on and switch-off brightness for night mode in the parameters, in day mode the always visible brightness values are used.

Brightness on ON telegram (night)

If the dimmer is in night mode, this value is activated by ON telegram via object 27 and suitable parameterization.

Brightness on OFF telegram (night)

If the dimmer is in night mode, this value is activated by OFF telegram via object 27 and suitable parameterization.

Fade time for day/night switching

This fade time is only active if switching on day/night telegram is used. If switching on next on/off telegram is used, the regular fade time of the respective on or off telegram is active. The period refers to a complete dimming process of 0-100%.

Object change Brightness (rel.)

To change the brightness via relative dimming commands, the following object is available, if activated via parameters:

Group object	Type KNX	Size	Direction
GO 28 RGB 1: Brightness dimming rel. - Brighter/Darker	3.007	4 Bit	From KNX

Minimal brightness while changing with object

This parameter can be used to set the minimum brightness that can be achieved by relative dimming. If the current brightness is below the minimum value, the brightness cannot be reduced via object 28.

Maximal brightness while changing with object

This parameter can be used to set the maximum brightness that can be achieved by relative dimming. If the current brightness is above the maximum value, the brightness cannot be increased via object 28.

Fade time while increasing brightness with object

This fade time is active when the brightness is increased by relative dimming with object 28. The period refers to a complete dimming process of 0-100%.

Fade time while decreasing brightness with object

This fade time is active when the brightness is decreased by relative dimming with object 28. The period refers to a complete dimming process of 0-100%.

Object set value Brightness (abs.)

The following object is used to control the brightness via dimming value, if it has been activated via parameters:

Group object	Type KNX	Size	Direction
GO 29 RGB 1: Brightness dimming abs. - Set value	5.001	1 Byte	From KNX

Minimal value for changing brightness by object

This parameter can be used to configure which minimum brightness can be reached via object 29. If a value below the minimum value is received, the dimmer is controlled with the minimum value. If a value >0% is set here, the following parameter is also visible:

Switch off dimmer with telegram value 0%

Here it is to select whether the dimmer is switched off when a value of 0% is received.

Maximal value for changing brightness by object

This parameter can be used to configure the maximum brightness that can be achieved via object 29. If a value above the maximum value is received, the dimmer is controlled with the maximum value.

Fade time while increasing brightness with object

This fade time is active when the brightness is increased by receiving values via object 29. The period is related to a complete dimming process of 0-100%.

Fade time while decreasing brightness with object

This fade time is active when the brightness is decreased by receiving values via object 29. The period is related to a complete dimming process of 0-100%.

F. RGB 1: Scene function

Description	Fade time on activation of scene	00:00:04	hh:mm:ss
General settings	Scene 1	Color	
DMX settings	Color	#FF0000	
Logic / Timer	Number	1	
Channel 1: RGB	Scene 2	Learnable	
RGB 1: General	Number	2	
RGB 1: Scene function	Scene 3	No reaction	
	Scene 4	No reaction	
	Scene 5	No reaction	
	Scene 6	No reaction	
	Scene 7	No reaction	
	Scene 8	No reaction	

If the scene function is activated, the following group object appears:

Group object	Type KNX	Size	Direction
GO 40 RGB 1: Scene - Activ./Lrn.	18.001	1 Byte	From KNX

Fade time on activation of scene

Here the period can be set in which the received scene is dimmed to. The period refers to a complete dimming process of 0-100%.

Scene 1-16

These parameters can be used to configure the reaction of the channel when the respective scene is received.

It is available:

- No reaction
- Color
The output is switched to the set color value if the scene of the corresponding number was received.
- Learnable
With the help of a scene control telegram, the current state at the output for the respective scene can be saved here. Thus the scene can be adapted by the user without ETS download.

Number

With this parameter any scene number between 1 and 64 can be assigned to the scene. No scene numbers may be assigned twice.

G. Sequencer 1: Sequencer

Description	Channel name	Sequencer 1
General settings	Steps of sequencer	2
DMX settings	Resume sequence after man. operation	After off-time
Logic / Timer	Off-time	00:30:00 hh:mm:ss
Channel 1: Sequencer	Step after man. operation	Active step
Sequencer 1: Sequencer	Polarity of object "Sequence on/off"	Switch on with 0 Switch on with 1
	Behavior on switching on	Step 1
	Behavior on switching off	Complete actual step
	Step 1:	Step 1
	Start by time	Disabled Start by time of day
	Start time	00:00:01 hh:mm:ss
	Start by ON/OFF telegram	Disabled Enabled
	Start by scene number	Disabled Enabled
	Start scene	1
	Action	Brightness
	Brightness	100 %
	Dimmer channel	1
	Fade time	00:00:00 hh:mm:ss
	Step 2:	Step 2
	Start by time	Start after last trigger
	Start time	00:00:01 hh:mm:ss
	Start by ON/OFF telegram	Disabled Enabled
	Start by scene number	Disabled Enabled
	Start scene	2
	Action	Color
	Color	#FF3300
	RGB channel	2
	Fade time	00:00:00 hh:mm:ss

The sequencer can be used to create complex sequence programs consisting of up to 32 individual steps for the dimmer channel. The individual steps can be activated under the following starting conditions:

- At a fixed time of day
- After a waiting time from a previous step has elapsed
- By on/off telegram
- When receiving a parameterized scene number

When a step is activated, a color can be dimmed to or a scene number can be sent, and a step or a whole sequence of steps can be repeated cyclically.

The following objects are available for the general control of the sequencer:

Group object	Type KNX	Size	Direction
GO 653 Sequencer 1: Sequence suspend - Suspend/Resume	1.001	1 Bit	From KNX
GO 654 Sequencer 1: Sequence on/off - Switch	1.001	1 Bit	From KNX

The following parameters determine the general behavior of the sequencer:

Steps of sequencer

Number of steps (0...32) to be used

Resume sequence after man. operation

An activated sequence can always be interrupted or continued via object 653, an ON telegram interrupts the sequence, and with an OFF telegram it is continued.

A sequence is also interrupted after manual operation, i.e. after commands for dimmer, automatic mode, slumber or scene function.

In addition, this parameter determines how an interrupted sequence can still be continued:

- Only by object
The sequence can only be continued by object 653.
- After off-time
The sequence is continued after the set off-time.

- On next activated step
The sequence is continued with the next activated step, the next step can be activated by object or time-controlled.

Off-time

Only visible if the sequence is to be continued after off-time, with this parameter the off-time can be configured.

Step after man. operation

This step is executed when resuming after manual operation, the function of the set step is always executed, regardless of its otherwise set starting conditions.

Polarity of object "Sequence on/off"

This parameter can be used to set the telegram value with which the sequence can be switched on and off via object 654. If the sequence is switched off, any further activation of a step is disabled.

Behavior on switching on

Here it is determined how the sequencer behaves when switched on by object 654:

- No reaction
No function is executed, the sequencer waits for steps to be activated.
- Step x
The function of the step is executed (independent of the other set start conditions of the step), the sequence is then continued according to its configuration from this step onwards.

Switching on also reactivates a sequence interrupted by manual operation.

Behavior on switching off

Here it is determined how the sequencer behaves when switched off by object 654:

- Complete actual step
If the sequencer is in a dimming process, it is completed.
- Step x
The function of the step is executed (independent of the other set start conditions of the step).
- Stop immediately
If the sequencer is in a dimming process, it is stopped.

Apart from the set behavior when switching off, any further activation of a step after switching off is disabled until the sequencer is switched on again by object 654.

Step 1-32:

Step 2:	Step 2
Start by time	Start after last trigger
Start time	00:00:01 hh:mm:ss
Start by ON/OFF telegram	<input type="radio"/> Disabled <input checked="" type="radio"/> Enabled
Start by scene number	<input type="radio"/> Disabled <input checked="" type="radio"/> Enabled
Start scene	2
Action	Color
Color	#FF3300
RGB channel	2
Fade time	00:00:00 hh:mm:ss

When a step is activated, its parameters for configuration appear.

In the text box at the top right with the content "Step x", you can enter your own name for the step. This designation serves for better orientation of the user and has no influence on the function of the step.

Start by time

This parameter is used to configure a temporal start condition of the step:

- Disabled
Start condition not used
- Start at a fixed time of day
Here the time of day at which the step should start can be entered. When using this start condition, the current time must have been received via the following object:

Group object	Type KNX	Size	Direction
GO 5 Time of Day - Set	10.001	3 Byte	From KNX

i If no valid time was received by object 5, all start conditions at fixed times of day are not active.

i The time is continuously updated by the device through its internal timers, but component tolerances always result in a deviation from the actual time. Therefore, the current time should be sent to the device by a precise timer at least twice a day in order to keep the deviation as small as possible.

- Start after last trigger
Here you can specify the time interval to wait after the previous activation before executing the step. This start condition is not available for step 1.

Start time

Here either the time day or the waiting time can be specified for the execution of the current step, if a timed start condition is used.

Start by ON/OFF telegram

When using this start condition, a separate object is available for each step:

Group object	Type KNX	Size	Direction
GO 655-686 Sequencer 1: Sequence Step x on/off - Switch	1.001	1 Bit	From KNX

An ON telegram to one of these objects activates the respective step, the sequence is then continued according to its configuration from this step onwards.

An OFF telegram also activates this step, but resets the sequence at the same time.

Start by scene number

When using this start condition, the following object becomes visible:

Group object	Type KNX	Size	Direction
GO 651 Sequencer 1: Sequence scene - Activate step	18.001	1 Byte	From KNX

A telegram with the set scene on this object activates the respective step, the sequence is then continued according to its configuration from this step onwards.

All steps with this start condition are controlled by this object.

Action

When the step is activated, the configured function is executed, the following functions are available for selection:

- None
No function is executed, for example this can be used to implement a switch-on delay for a sequence.
- Start loop
The sequence continues from the selected step. Parameters for the initial step of the loop and the number of loops become visible.
- Send scene number
When using this function, the following object becomes visible:

Group object	Type KNX	Size	Direction
GO 652 Sequencer 1: Sequence scene - Send scene	18.001	1 Byte	To KNX

A parameter for the scene number to be sent becomes visible. When the step is activated, this scene number is sent via the object.

All steps send the scene number via this object, if this function is used for the respective step.

- Brightness
Parameters for brightness, fade time and used dimmer channel become visible. The action of the step uses the DMX addresses of the specified dimmer channel. When this step is activated, the dimmer dims from the current brightness value to the specified brightness with the parameterized fade time. This time is related to a complete dimming process of 0-100%
- Color
Parameters for color, fade time and used RGB/RGBW channel become visible. The action of the step uses the DMX addresses of the specified RGB/RGBW channel. When this step is activated, the dimmer dims from the current color value to the specified color with the parameterized fade time. This time is related to a complete dimming process of 0-100%.

Operating mode DMX Slave

D. DMX settings

The screenshot shows the 'DMX settings' page for a KNX DMX Gateway 544. It is configured as a 'DMX Slave'. Key settings include:

- Monitoring channels: 0
- DMX communication: Enabled
- Start DMX after restart of device: Enabled
- Enable DMX after disabled by object: After delay time (00:00:10)
- Disable DMX after enabled by object: After delay time (00:00:10)
- Diagnostic object: Send ON on DMX communication

KNX Gateway: DMX Slave

Monitoring channels

Up to 64 monitoring channels can be activated here.

Start DMX After restart of device

This parameter can be used to determine whether the reception of DMX telegrams is activated or deactivated after device restart. If this parameter is set to disabled, the reception can only be started via object 6:

Group object	Type KNX	Size	Direction
GO 6 DMX communication -Enable/Disable	1.001	1 Bit	From KNX

Enable DMX after disabled by object

This parameter can be used to determine how the reception of DMX telegrams can be reactivated after it has been disabled via object 6. The following can be selected:

- Only by object
- After delay time
A parameter for entering the delay time appears.

Disable DMX after enabled by object

This parameter can be used to determine how the reception of DMX telegrams can be deactivated again after it has been enabled via object 6. The following can be selected:

- Only by object
- After delay time
A parameter for entering the delay time appears.

Diagnostic object

With this parameter the following object becomes visible to visualize the state of the DMX communication:

Group object	Type KNX	Size	Direction
GO 4 Diagnostic - DMX communication	1.001	1 Bit	To KNX

This parameter can also be used to set whether an ON or OFF telegram is sent when DMX communication is present.

E. Monitoring 1: General

Name (30 characters)

An arbitrary name can be assigned for the channel. However, this should be clear and meaningful, this makes it easier to work with the associated group objects, because the given name is displayed there as a label. If no name is assigned, the group objects are named "Monitoring 1: ...".

Type of value object

This parameter defines the type of the value object, you can choose between:

- Dimming value:

Group object	Type KNX	Size	Direction
GO 16 Monitoring 1: Monitoring output - State on/off	1.001	1 Bit	To KNX
GO 17 Monitoring 1: Monitoring output - State dimming value	5.001	1 Byte	To KNX

- RGB value:

Group object	Type KNX	Size	Direction
GO 16 Monitoring 1: Monitoring output - State on/off	1.001	1 Bit	To KNX
GO 17 Monitoring 1: Monitoring output - State RGB value	232.600	3 Byte	To KNX

ON when dimming value over

If the type of the value object is a dimming value, this parameter determines which dimming value must be exceeded for an ON telegram to be transmitted via object 16.

DMX address

If the type of the value object is a dimming value, the DMX address to be monitored can be specified here.

Red. DMX address

Green: DMX address

Blue: DMX address

If the type of the value object is an RGB value, the DMX addresses to be monitored for the respective color value can be specified here. They are sent together in an RGB value on KNX.

Send state

This parameter defines the behavior of the state objects:

- Disabled
State objects are deactivated and not displayed.
- Only on read
State objects send only on request.
- On change
The switch object sends a single OFF telegram if the output value falls below the switch-on dimming value or changes to black (RGB #000000), a single ON telegram if it exceeds the switch-on dimming value or changes from black to another color.

Time for cyclic state

With this parameter, the cycle time can be set, when "Cyclic and on change" is selected for sending state.

Logic / Timer

The following settings are available for the use of logic and timers:

A. Logic / Timer

Function 1 - 16

These channels contain additional functions such as timing and logic. All these 16 additional functions are identical.

The following options are selectable:

- Disabled
- Timer
- Logic

Function type (Disabled)

If the function type is set to "Disabled", no timer or logic specific parameters and group objects are available.

Function type (Timer)

The timer-specific parameters and group objects are available.

Function type (Logic)

The logic-specific parameters and group objects are available.



These additional logic and timer functions can be linked to one another by means of the associated group objects. This also allows to create complex structures. For this purpose, the output of a function is set to the same group address as the input of the next function.

B. Function 1 - 16 (Timer)

Function name (10 Characters)

The function name can be chosen freely. The name is visible in the group object entry in the ETS software. This makes it easier to work with the associated group objects, because the given name is displayed there as a label.

Timer type (Switch-on delay)

A timer that switches ON after duration defined in 'Delay time [s]' parameter.

The output value can be inverted by parameter 'Output' (Not inverted / inverted).

Input -----1-----0-----
Output -----| -T- 1-----0-----

Group object	Type KNX	Size	Direction
Timer - Switch-on delayed - Input	1.002	1 Bit	From KNX
Timer - Switch-on delayed - Output	1.002	1 Bit	To KNX

Timer type (Switch-off delay)

A timer that switches OFF after duration defined in 'Delay time [s]' parameter.

The output value can be inverted by parameter 'Output'. (Not inverted / inverted)

Input -----1-----0-----
Output -----1-----| -T- 0-----

Group object	Type KNX	Size	Direction
Timer - Switch-off delayed - Input	1.002	1 Bit	From KNX
Timer - Switch-off delayed - Output	1.002	1 Bit	To KNX

Timer type (Switch-on and -off delay)

A timer that switches ON and OFF after duration defined in 'Delay time [s]' parameter.

The output value can be inverted by parameter 'Output'. (Not inverted / inverted)

Input -----1-----0-----
Output -----| -T- 1-----| -T- 0-----

Group object	Type KNX	Size	Direction
Timer - Switch-on/off delayed - Input	1.002	1 Bit	From KNX
Timer - Switch-on/off delayed - Output	1.002	1 Bit	To KNX

Timer type (Impulse (Staircase))

Timer with impulse that – after being switched **ON** – **automatically switches OFF** after a defined duration defined in 'Delay time [s]' parameter.

The output value can be inverted by parameter 'Output'. (Not inverted / inverted)

Input -----1-----0-----
Output -----1-T-0-----

Group object	Type KNX	Size	Direction
Timer - Switch-impulse (staircase) - Input	1.002	1 Bit	From KNX
Timer - Switch-impulse (staircase) - Output	1.002	1 Bit	To KNX

Each timer can be stopped by sending the opposite value to its input group object.

For example:

An already started switch on timer can be stopped by sending OFF (0) to its input group object.

C. Function 1 - 16 (Logic)

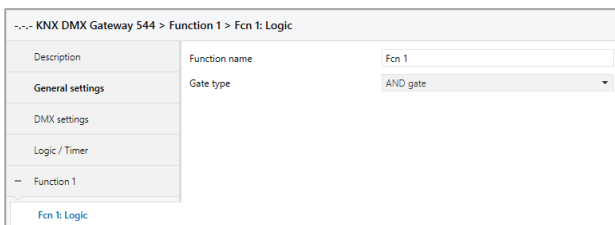

Function name (10 Characters)

The function name can be chosen freely.

The name is visible in the group object entry in the ETS software. This makes it easier to work with the associated group objects, because the given name is displayed there as a label.

Group object	Type KNX	Size	Direction
Logic - Gate input A - Input	1.002	1 Bit	From KNX
Logic - Gate input B - Input	1.002	1 Bit	From KNX
Logic - Gate output - Output	1.002	1 Bit	To KNX

Gate type (AND gate)

The output is triggered on (1), if both inputs are switched on (1).

Gate type (OR gate)

The output is triggered on (1), if one or both inputs are switched on (1).

Gate type (XOR gate)

The output is triggered on (1), if the two inputs are not equal.

Gate type (NAND gate)

The output is triggered on (1), if one or both inputs are switched off (0).

Gate type (NOR gate)

The output is triggered on (1), if both inputs are switched off (0).

Gate type (XNOR gate)

The output is triggered on (1), if both inputs are equal.

Gate type (INVERTER)

Input on (1) is converted into output off (0). Input off (0) is converted into output on (1).

Group object	Type KNX	Size	Direction
Logic - Gate input - Input	1.002	1 Bit	From KNX
Logic - Gate output - Output	1.002	1 Bit	To KNX



WARNING

- The device must be mounted and commissioned by an authorized electrician.
- The prevailing safety rules must be heeded.
- The device must not be opened.
- For planning and construction of electric installations, the relevant guidelines, regulations and standards of the respective country are to be considered.



ETS6 Database

www.weinzierl.de/en/products/544/ets6

Datasheet

www.weinzierl.de/en/products/544/datasheet

CE Declaration

www.weinzierl.de/en/products/544/ce-declaration

Weinzierl Engineering GmbH

D-84508 Burgkirchen / Alz
Deutschland
www.weinzierl.de
info@weinzierl.de

2023/02/14