



Gateway for integration of Daikin air conditioners into KNX TP-1 (EIB) control systems

Compatible with VRV and Sky line air conditioners commercialized by Daikin
Application's Program Version: 2.1

USER MANUAL

Issue date: 07/2020 r1.3 ENGLISH

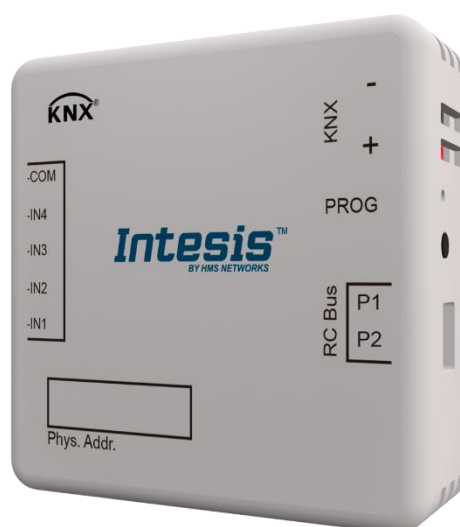

Important User Information

Disclaimer

The information in this document is for informational purposes only. Please inform HMS Industrial Networks of any inaccuracies or omissions found in this document. HMS Industrial Networks disclaims any responsibility or liability for any errors that may appear in this document.

HMS Industrial Networks reserves the right to modify its products in line with its policy of continuous product development. The information in this document shall therefore not be construed as a commitment on the part of HMS Industrial Networks and is subject to change without notice. HMS Industrial Networks makes no commitment to update or keep current the information in this document.

The data, examples and illustrations found in this document are included for illustrative purposes and are only intended to help improve understanding of the functionality and handling of the product. In view of the wide range of possible applications of the product, and because of the many variables and requirements associated with any particular implementation, HMS Industrial Networks cannot assume responsibility or liability for actual use based on the data, examples or illustrations included in this document nor for any damages incurred during installation of the product. Those responsible for the use of the product must acquire sufficient knowledge in order to ensure that the product is used correctly in their specific application and that the application meets all performance and safety requirements including any applicable laws, regulations, codes and standards. Further, HMS Industrial Networks will under no circumstances assume liability or responsibility for any problems that may arise as a result from the use of undocumented features or functional side effects found outside the documented scope of the product. The effects caused by any direct or indirect use of such aspects of the product are undefined and may include e.g. compatibility issues and stability issues.

Gateway for integration of Daikin air conditioners into KNX TP-1 (EIB) control systems.

Compatible with VRV and SKY line air conditioners commercialized by Daikin.

Application's Program Version: 2.1

ORDER CODE	LEGACY ORDER CODE
INKNXDAI001R100	DK-RC-KNX-1i

INDEX

1. Presentation	6
2. Connection	7
2.1. INKNXDAl001R100 without DAIKIN Remote Controller.....	7
2.2. INKNXDAl001R100 with DAIKIN Remote Controller	7
3. Configuration and setup	9
4. ETS Parameters.....	10
4.1. General dialog	10
4.1.1. INKNXDAl001R100 is master in P1/P2 bus.....	11
4.1.2. Send READs for Control_ objects on bus recovery	11
4.1.3. Scene to load on bus recovery / startup	12
4.1.4. Disallow control from remote controller	12
4.1.5. Enable func "Control_ Lock Control Obj"	13
4.1.6. Enable func "Operating Hours Counter"	13
4.1.7. Enable "Error Code" object.....	13
4.1.8. Enable "Error Text" object.....	14
4.2. Mode Configuration dialog	14
4.2.1. When mode is AUTO Status_ objects report actual operating status	14
4.2.2. Enable use of Heat / Cool bit-type obj	15
4.2.3. Enable PID-Compat. Scaling Mode Objects.....	15
4.2.4. Enable use of + / - object for Mode.....	16
4.2.5. Enable use of bit-type Mode objects (for control)	16
4.2.6. Enable use of bit-type Mode objects (for status)	16
4.2.7. Enable use of Text object for Mode	17
4.2.8. Enable use of Legacy_ object for Mode	17
4.3. Special Modes Configuration dialog.....	18
4.3.1. Enable use of POWER mode	18
4.3.2. Enable use of ECONOMY mode	19
4.3.3. Enable use of ADDITIONAL HEATING mode.....	20
4.3.4. Enable use of ADDITIONAL COOLING mode	20
4.4. Fan Speed Configuration dialog.....	21
4.4.1. Available fan speeds in Indoor Unit	21
4.4.2. AUTO fan speed available in Indoor Unit	21
4.4.3. DPT object type for fanspeed	22
4.4.4. Enable use of +/- object for Fan Speed	23
4.4.5. Enable use of bit-type Fan Speed objects (for Control)	24
4.4.6. Enable use of bit-type Fan Speed objects (for Status)	24
4.4.7. Enable use of Text object for Fan Speed	25
4.4.8. Enable use of Legacy_ obj for Fan Speed	25
4.5. Vane Up-Down Configuration dialog.....	26
4.5.1. Indoor unit has Up-Down Vanes	26
4.5.2. Enable "Control_ Vane U-D Swing".....	26
4.5.3. DPT object type for Vane Up-Down	27
4.5.4. Enable use of +/- obj for Vane Up-Down.....	28
4.5.5. Enable use of bit-type Vane U-D objects (for Control).....	28
4.5.6. Enable use of bit-type Vane U-D objects (for Status).....	29
4.5.7. Enable use of Text object for Vane U-D	29
4.5.8. Enable use of Legacy_ obj for Vane U-D	29
4.6. Temperature Configuration dialog.....	30
4.6.1. Status_ AC Return Temp shows temperature from.....	30
4.6.2. Periodic sending of "Status_ AC Setp"	30
4.6.3. Transmission of "Status_ AC Ret Temp".....	31
4.6.4. Enable use of +/- obj for Setp Temp	31
4.6.5. Enable limits on Control_ Setpoint obj	31
4.6.6. Ambient temp. ref. is provided from KNX.....	32
4.7. Scene Configuration dialog	34

4.7.1. Enable use of scenes	34
4.7.2. Scenes can be stored from KNX bus	34
4.7.3. Enable use of bit objects for scene execution	35
4.7.4. Scene "x" preset	35
4.8. Switch-Off Timeouts Configuration dialog	37
4.8.1. Enable use of Open Window / Switch off timeout function	37
4.8.2. Enable use of Occupancy function	38
4.8.3. Enable use of SLEEP timeout	40
4.9. Binary Input "x" Configuration dialog	41
4.9.1. Enable use of Input "x"	41
4.9.2. Contact type	41
4.9.3. Debounce time	41
4.9.4. Disabling function	41
4.9.5. Function	42
5. Specifications	49
6. AC Unit Types compatibility.	50
7. Error Codes	51
Appendix A - Communication Objects Table	53

1. Presentation



INKNXDAI001R100 allows a complete and natural integration of DAIKIN air conditioners with KNX control systems.

Compatible with all SKY Air and VRV models commercialized by DAIKIN.

Main features:

- Reduced dimensions, quick installation.
- Direct connection to P1/P2 bus, the bus that connects the AC indoor unit and the wired remote controller.
- Multiple objects for control and status (bit, byte, characters...) with KNX standard datapoint types.
- Status objects for every control available.
- Special Modes available (Power, Economy, Additional Heating and Additional Cooling).
- Timeout for Open Window and Occupancy. Sleep function also available.
- Control of the AC unit based in the ambient temperature read by the own AC unit, or in the ambient temperature read by any KNX thermostat.
- Total Control and Monitoring of the AC unit from KNX, including monitoring of AC unit's state of internal variables, running hours counter (for filter maintenance control), and error indication and error code.
- AC unit can be controlled simultaneously by the remote controller of the AC unit and by KNX.
- Up to 5 scenes can be saved and executed from KNX, fixing the desired combination of Operation Mode, Set Temperature, Fan Speed, Vane Position and Remote Controller Lock in any moment by using a simple switching.
- Four potential-free binary inputs provide the possibility to integrate many types of external devices. Also configurable from ETS, they can be used for switching, dimming, shutter/blind control, and more

2. Connection

Connection of the INKNXDAI001R100 to the AC indoor unit

2.1. INKNXDAI001R100 without DAIKIN Remote Controller

The INKNXDAI001R100 can be connected directly to the P1/P2 bus of the indoor unit (no Daikin remote controller -RC from now on- also connected in the P1 P2 bus). If this is the case, INKNXDAI001R100 must be configured as master (using the ETS software), see connection diagram below.

2.2. INKNXDAI001R100 with DAIKIN Remote Controller

If a Daikin remote controller (RC) is present and connected to the P1/P2 bus, there are two configuration options:

- If we want to use the RC as master, its PCB switch must be set at "M" position and the INKNXDAI001R100 must be configured as slave.
- If we want to use the RC as slave, its PCB switch must be set at "S" position and the INKNXDAI001R100 must be configured as master.

Check compatible Daikin remote controllers in the link provided in section 6.

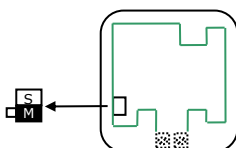

Figure 2.1 Daikin RC PCB backside, MAIN/SUB switch

Special mention must be made with the use of Daikin's IR wireless remote controllers, in this case Daikin's IR must be slave and the INKNXDAI001R100 must be master, otherwise not all the features will be available from KNX.

Disconnect mains power from the AC unit and use a 2-wire cable with a diameter of 0.75mm² to 1.25mm² for the connection of INKNXDAI001R100, Daikin's remote controller and its corresponding indoor unit. Screw the suitably peeled cable ends in the corresponding P1/P2 terminals of each device, as summarized in the **Figure 2.2**.

Maximum P1/P2 bus length is 500 meters. DAIKIN RC and INKNXDAI001R100 are polarity insensitive.

Connection of the INKNXDAI001R100 to the KNX bus:

Disconnect power of the KNX bus. Connect the INKNXDAI001R100 to the KNX TP-1 (EIB) bus using the KNX standard connector (red/grey) of the INKNXDAI001R100, respect polarity.

Reconnect power of the KNX bus, and mains power of the AC unit.

Connections diagrams:

INKNXDAI001R100 without DAIKIN RC

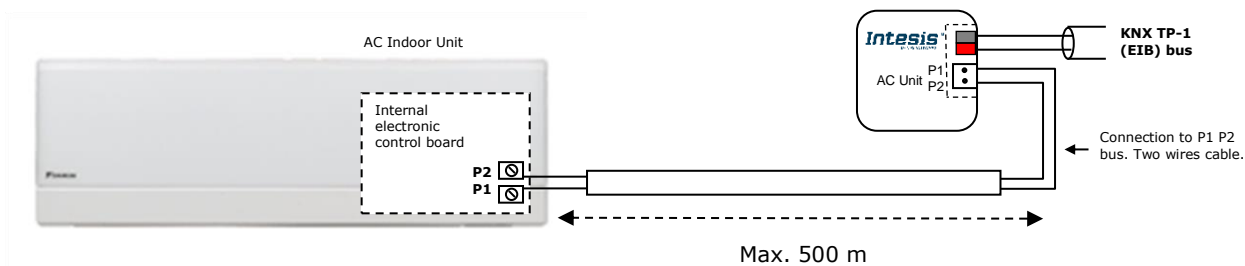

INKNXDAI001R100 with DAIKIN RC

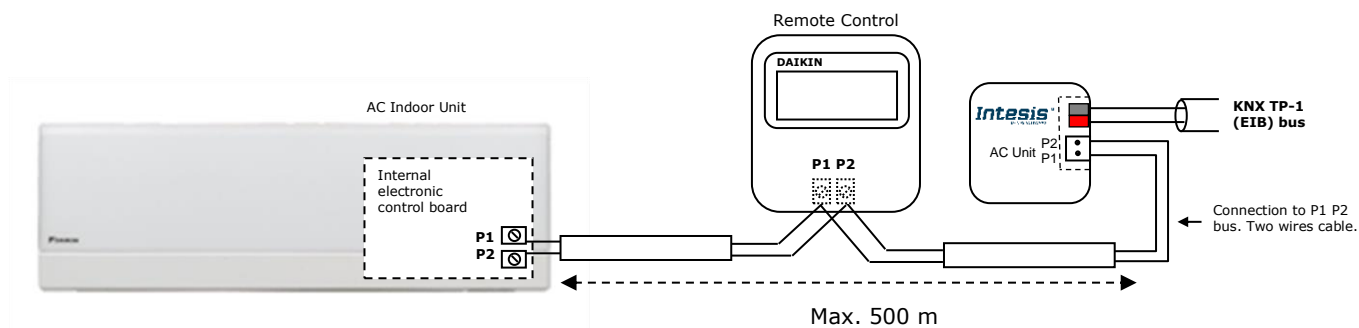

Figure 2.2 Connections diagrams

3. Configuration and setup

This is a fully compatible KNX device which must be configured and setup using standard KNX tool ETS.

ETS database for this device can be downloaded from:

<https://intesis.com/products/ac-interfaces/daikin-gateways/daikin-knx-vrv-dk-rc-knx-1>

Please consult the README.txt file, located inside the downloaded zip file, to find instructions on how to install the database.

IMPORTANT: Do not forget to select the correct settings of AC indoor unit being connected to the INKNXDAI001R100 (Fan speed and Vane), this is in "Parameters" of the device in ETS.

4. ETS Parameters

When imported to the ETS software for the first time, the gateway shows the following default parameter configuration:

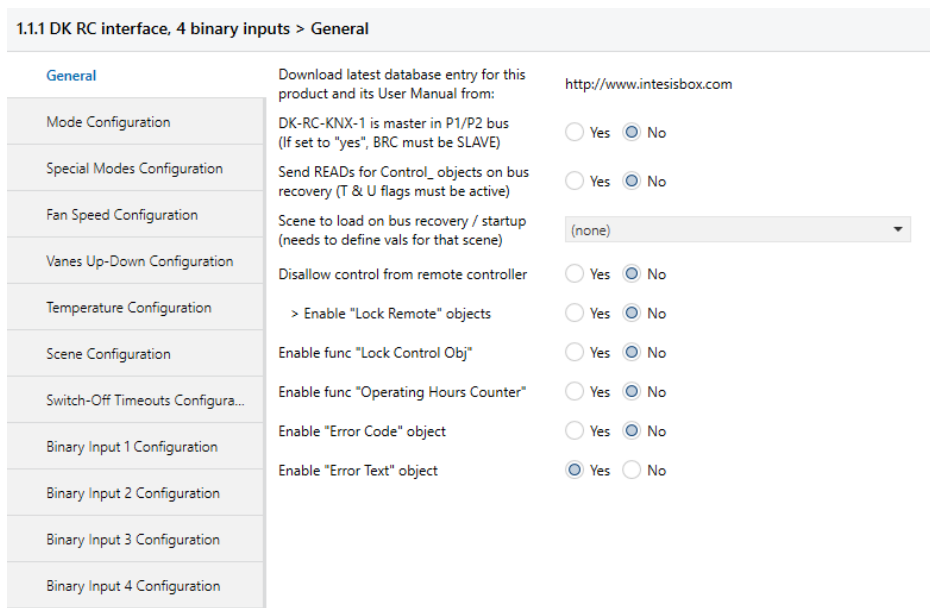

Figure 4.1 Default parameter configuration

With this configuration it's possible to send On/Off (*Control_ On/Off*), change the AC Mode (*Control_ Mode*), the Fan Speed (*Control_ Fan Speed*) and also the Setpoint Temperature (*Control_ Setpoint Temperature*). The *Status_* objects, for the mentioned *Control_* objects, are also available to use if needed. Also objects *Status_ AC Reference Temp*, *Status_ Error/Alarm* and *Status_ Error Text Code* are shown.

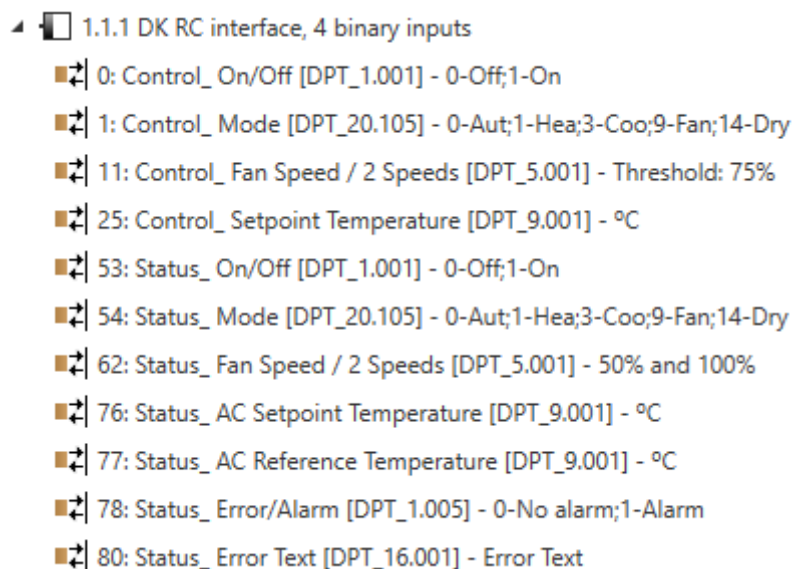

Figure 4.2 Default communication objects

4.1. General dialog

Inside this parameter's dialog it is possible to activate or change the parameters shown in the **Figure 4.1**.

The first field shows the URL where to download the database (or pr3) and the user manual for the product.

4.1.1. INKNXDAI001R100 is master in P1/P2 bus

This parameter changes the gateway's behavior, being able to program it as master or slave in P1 P2 bus.

- If set to "no", the gateway will work as a slave and it will be necessary to have a BRC remote controller configured as a master.
- If set to "yes" the gateway will be master of the bus. It is not necessary to have any BRC remote controller in this case but, if there are, they must be configured as slaves. The next parameter is also shown when selecting INKNXDAI001R100 as master in P1 P2 bus:

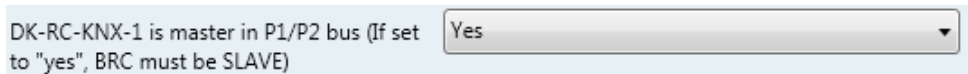

Figure 4.3 Parameter detail

➤ If VRV system, indoor unit is slave of Operating Mode:

VRV indoor units can be configured as master or slave of Operating Mode.

If *configured as slave = "yes"*, the unit will take the operating mode of the master indoor unit in the system (i.e. if master unit is in Heat mode, slaves will be also in Heat mode).

If *configured as slave = "no"*, it means is the master unit, then the unit will take the operating mode selected through the BRC or INKNXDAI001R100, and the other slave indoor units will adopt this operating mode.

⚠ Important: Only ONE indoor unit can be configured as master of operating mode. If more than one indoor unit is configured as master, the system will not work properly.

There are some compatible Operation Modes that slave indoor units can use while the master indoor unit is operating in another one:

MASTER INDOOR UNIT	SLAVE INDOOR UNIT(s)
Heat	Heat, Fan
Cool	Cool, Dry, Fan
Dry	Dry, Cool, Fan
Fan	Fan

Table 4.1 Operating Mode compatibility

4.1.2. Send READs for Control_ objects on bus recovery

When this parameter is enabled, INKNXDAI001R100 will send READ telegrams for the group addresses associated on its *Control_* objects on bus recovery or application reset/start-up.

- If set to "no" the gateway will not perform any action.
- If set to "yes" all *Control_* objects with both Transmit (T) and Update (U) flags enabled will send READs and their values will be updated with the response when received.

Send READs for Control_ objects on bus recovery (T and U flags must be active)

> Delay before sending READs (sec)

Figure 4.4 Parameter detail

➤ Delay before sending READs (sec):

With this parameter, a delay can be configured between 0 and 30 seconds for the READs sent by the *Control_* objects. This is to give time enough to other KNX devices on the bus to start-up before sending the READs.

4.1.3. Scene to load on bus recovery / start-up

This parameter executes a selected scene on bus recovery or startup, only if the selected scene has an enabled preset or values previously saved from KNX bus (see Scene Configuration dialog).

If the gateway is disconnected from the indoor unit (P1 & P2 bus not connected) the scene will not be applied, even when connecting to the indoor unit again.

Scene to load on bus recovery / startup (needs to define vals for that scene)

Figure 4.5 Parameter detail

4.1.4. Disallow control from remote controller

This parameter allows:

- 1- Having the remote controller always locked, or
 - 2- Decide through a new communication object if the RC is locked or not.
- If set to **"yes"** all the actions performed through the remote controller will be disabled.
 - If set to **"no"** the remote controller will work as usually. It also appears a new parameter and the communication object *Control_ Lock Remote Control*.

31 Control_ Lock Remote Control [DPT_1.002]

Disallow control from remote controller

> Enable comm obj "Ctrl_ Remote Lock"

Figure 4.6 Communication object and parameter detail

➤ Enable comm obj "Ctrl_ Remote Lock":

If set to **"no"** the object will not be shown.

If set to **"yes"** the *Control_ Lock Remote Control* object will appear.

- When a **"1"** value is sent to this communication object, the remote controller is locked. To be unlocked a **"0"** value must be sent. The gateway remembers the last value received even if a KNX bus reset/failure happens.

⚠ **Important:** *If an initial scene is enabled and it has as Value for Remote Lock (unchanged) or unlocked, this would unlock the remote controller because the initial scene has priority over the Control_ Lock Remote Control communication object.*

4.1.5. Enable func “Control_ Lock Control Obj”

This parameter shows/hide the *Control_ Lock Control Obj* communication object which, depending on the sent value, locks or unlocks ALL the *Control_* communication objects except itself.

➡|32 Control_ Lock Control Objects [DPT_1.002]

- If set to “no” the object will not be shown.
- If set to “yes” the *Control_ Lock Control Objects* object will appear.
 - When a “1” value is sent to this communication object, all the *Control_* objects will be locked. To unlock a “0” value must be sent, as the gateway remembers the last value received even if a KNX bus reset/failure happens.

4.1.6. Enable func “Operating Hours Counter”

This parameter shows/hides the following objects which counts the number of operating hours/seconds for the INKNXDAI001R100:

➡|87 Status_ Operation Hour Counter [DPT_7.001]
 ➡|88 Status_ Operation Second Counter [DPT_13.100]

- If set to “no” the object will not be shown.
- If set to “yes” these objects will appear.
 - *Status_ Operation Hour Counter* and *Status_ Operation Second Counter* can be read and send their values every time an hour is counted. The gateway keeps that count in memory and the status is sent also after a KNX bus reset/failure. Although this object is marked as a *Status_* object it also can be written to update the counter when needed. It is possible to reset counter written a “0” value.

⚠ **Important:** This object comes by default without the write (W) flag activated. If is necessary to write on it, this flag must be activated.

⚠ **Important:** This object will also return its status, every time a value is written, only if it's different from the existing one.

⚠ **Important:** If the stored value is 0 hours, the gateway will not send the status to KNX.

4.1.7. Enable “Error Code” object

This parameter shows/hides the *Status_ Error Code [2byte]* communication object which shows the indoor unit errors, if occurred, in numeric format.

➡|79 Status_ Error Code [2byte]

- If set to “no” the object will not be shown.
- If set to “yes” the *Status_ Error Code [2byte]* object will appear.
 - This object can be read and sends the indoor unit error, if occurred, in numeric format. If a “0” value is shown that means no error.

4.1.8. Enable “Error Text” object

This parameter shows/hides the *Status_ Error Text* communication object which shows the indoor unit errors, if occurred, in text format.

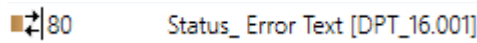

- If set to “no” the object will not be shown.
- If set to “yes” the *Status_ Error Text* object will appear.
 - This object can be read and sends the indoor unit error, if occurred, in text format. The errors shown have the same format as at the remote controller and at the error list from the indoor unit manufacturer. If the object’s value is empty that means no error.

4.2. Mode Configuration dialog

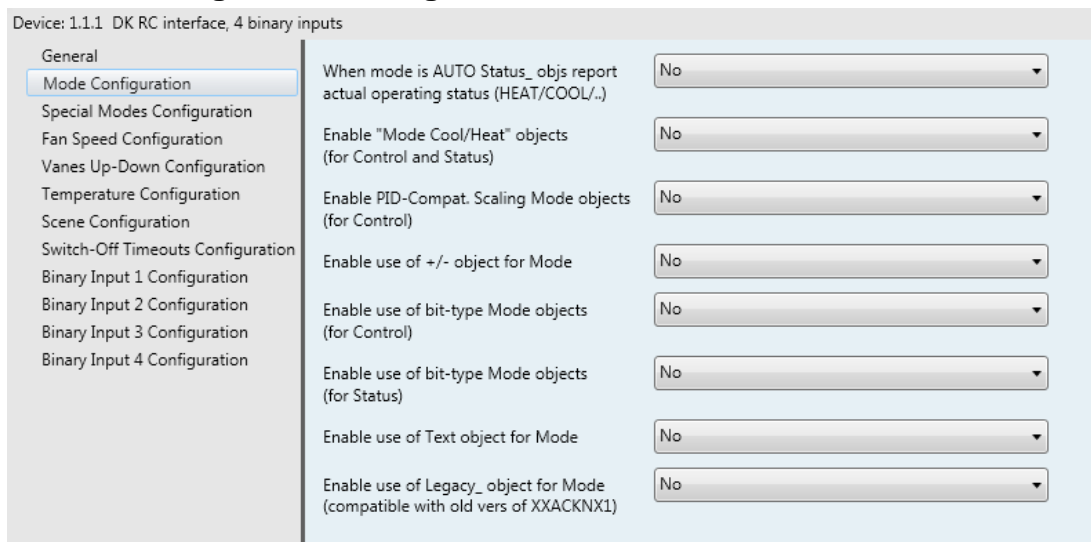
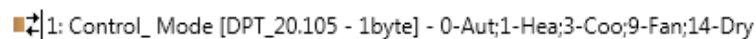

Figure 4.7 Default Mode Configuration dialog

All the parameters in this section are related with the different mode properties and communication objects.



The byte-type communication object for Mode works with the DTP_20.105. Auto mode will be enabled with a “0” value, Heat mode with a “1” value, Cool mode with a “3” value, Fan mode with a “9” value and Dry mode with a “14” value.

4.2.1. When mode is AUTO Status_ objects report actual operating status

This parameter shows the real status of the indoor unit when Auto mode is enabled.

- If set to “no”, when the indoor unit is set to Auto mode, all the *Status_* objects concerning mode will only show Auto enabled.
- If set to “yes”, when the indoor unit is set to Auto mode, all the *Status_* objects concerning mode will show the real mode which the machine is working (Cool, Heat, Dry, Fan). In case of the bitfield objects, also the *Status_ Mode Auto* will be shown enabled with a “1” value.

4.2.2. Enable use of Heat / Cool bit-type obj

This parameter shows/hides the *Control_* and *Status_ Mode Cool/Heat* communication objects.

↔ 2	Control_ Mode Cool/Heat [DPT_1.100]
↔ 55	Status_ Mode Cool/Heat [DPT_1.100]

- If set to **"no"** the objects will not be shown.
- If set to **"yes"** the *Control_* and *Status_ Mode Cool/Heat* objects will appear.
 - When a **"1"** value is sent to the *Control_* communication object, **Heat mode** will be enabled in the indoor unit, and the *Status_* object will return this value.
 - When a **"0"** value is sent to the *Control_* communication object, **Cool mode** will be enabled in the indoor unit, and the *Status_* object will return this value.

4.2.3. Enable PID-Compat. Scaling Mode Objects

This parameter shows/hides the *Control_ Mode Cool & On* and *Control_ Mode Heat & On* communication objects.

↔ 3	Control_ Mode Cool & On [DPT_5.001]
↔ 4	Control_ Mode Heat & On [DPT_5.001]

- If set to **"no"** the objects will not be shown.
- If set to **"yes"** the *Control_ Mode Cool & On* and *Control_ Mode Heat & On* objects will appear.
 - These objects provide compatibility with those KNX thermostats that control the demand of heating or cooling by using scaling (percentage) objects. In these thermostats, the percentage demand is meant to be applied on a fluid valve of the heating / cooling system.
 - INKNXDAI001R100 device does not provide individual control on the internal parts of the indoor unit (as can be its compressor, refrigerant valves, etc). Rather, it provides the same level of control as a (user) remote controller.
 - Objects "Control_ Mode Cool & On" and "Control_ Mode Heat & On" intend to bring compatibility between thermostats oriented to the control of custom heating / cooling systems and ready-made AC indoor units, by applying the following logic:
 - Whenever a non-zero value (>0%) is received at "Control_ Mode Cool & On", indoor unit will switch On in COOL mode.
 - Whenever a non-zero value (>0%) is received at "Control_ Mode Heat & On", indoor unit will switch On in HEAT mode.
 - Lastest updated object will define the operating mode
 - Indoor unit will switch off only when both objects become zero (0%) – or when an OFF is requested at object "0. On/Off [DPT_1.001 - 1bit]"

⚠ Important: These objects function is only to send On/Off and Cool/Heat to the indoor unit. The PID (Inverter system) is calculated by the indoor unit itself. Please consider

introducing an appropriate PID configuration to the external KNX thermostat to not interfere the indoor unit PID.

4.2.4. Enable use of + / - object for Mode

This parameter shows/hides the *Control_Mode* +/- communication object which lets change the indoor unit mode by using two different datapoint types.

🔧|10 Control_Mode +/- [DPT_1.008]

- If set to "no" the object will not be shown.
- If set to "yes" the *Control_Mode* +/- object and a new parameter will appear.

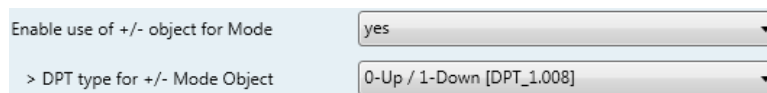

Figure 4.8 Parameter detail

➤ DPT type for +/- Mode Object

This parameter lets choose between the datapoints **0-Up / 1-Down [DPT_1.008]** and **0-Decrease / 1-Increase [DPT_1.007]** for the *Control_Mode* +/- object.

The sequence followed when using this object is shown below:



- Up / Increase
- Down / Decrease

4.2.5. Enable use of bit-type Mode objects (for control)

This parameter shows/hides the bit-type *Control_Mode* objects.

- 🔧|5: Control_Mode Auto [DPT_1.002 - 1bit] - 1-Set AUTO operating mode
- 🔧|6: Control_Mode Heat [DPT_1.002 - 1bit] - 1-Set HEAT operating mode
- 🔧|7: Control_Mode Cool [DPT_1.002 - 1bit] - 1-Set COOL operating mode
- 🔧|8: Control_Mode Fan [DPT_1.002 - 1bit] - 1-Set FAN operating mode
- 🔧|9: Control_Mode Dry [DPT_1.002 - 1bit] - 1-Set DRY operating mode

- If set to "no" the objects will not be shown.
- If set to "yes" the *Control_Mode* objects for Auto, Heat, Cool, Fan and Dry will appear. To activate a mode by using these objects a "1" value has to be sent.

4.2.6. Enable use of bit-type Mode objects (for status)

This parameter shows/hides the bit-type *Status_Mode* objects.

56	Status_ Mode Auto [DPT_1.002]
57	Status_ Mode Heat [DPT_1.002]
58	Status_ Mode Cool [DPT_1.002]
59	Status_ Mode Fan [DPT_1.002]
60	Status_ Mode Dry [DPT_1.002]

- If set to **"no"** the objects will not be shown.
- If set to **"yes"** the *Status_ Mode* objects for Auto, Heat, Cool, Fan and Dry will appear. When enabled, a mode will return a **"1"** through its bit-type object.

4.2.7. Enable use of Text object for Mode

This parameter shows/hides the *Status_ Mode Text* communication object.

61	Status_ Mode Text [DPT_16.001]
----	--------------------------------

- If set to **"no"** the object will not be shown.
- If set to **"yes"** the *Status_ Mode Text* object will appear. Also, in the parameters, will be shown five text fields, one for each mode, that will let modify the text string displayed by the *Status_ Mode Text* when changing mode.

> String when mode is AUTO	AUTO
> String when mode is HEAT	HEAT
> String when mode is COOL	COOL
> String when mode is FAN	FAN
> String when mode is DRY	DRY

Figure 4.9 Parameter detail

4.2.8. Enable use of Legacy_ object for Mode

This parameter shows/hides the *Legacy_ Mode* communication object.

90	Legacy_ Mode [Enumerated]
----	---------------------------

- If set to **"no"** the object will not be shown.
- If set to **"yes"** the *Legacy_ Mode* object will appear. This object lets change the indoor unit mode but it uses a different data type. It is used to maintain compatibility with old gateway models.
Auto mode will be enabled with a **"0"** value, Heat mode with a **"1"** value, Dry mode with a **"2"** value, Fan mode with a **"3"** value and Cool mode with a **"4"** value

4.3. Special Modes Configuration dialog

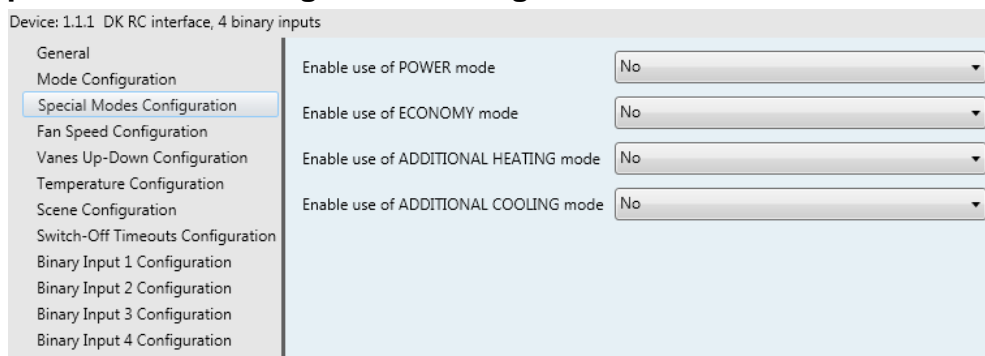

Figure 4.10 Default Special Modes Configuration dialog

The Special Modes can be parameterized through the ETS parameters dialog, and they can be used to give extra functionality.

- ⚠ **Important:** When executing any of the Special Modes, the real state of the indoor unit will NOT be shown in KNX.
- ⚠ **Important:** When the predefined time for the Special Mode is finished or a "0" value is sent to stop it. The previous state will be recovered.
- ⚠ **Important:** If a value concerning On/Off, Mode, Fan Speed or Setpoint Temperature is received from KNX while any Special Mode is running ("1"), the Special Mode will stop and the previous state will be recovered. The value received will be also applied then.
- ⚠ **Important:** If a value concerning On/Off, Mode, Fan Speed or Setpoint Temperature is modified through the remote controller, the Special Mode will stop WITHOUT recovering the previous state. Then the real indoor unit state will be shown in KNX including the new value received through the remote controller.

4.3.1. Enable use of POWER mode

This parameter shows/hides the *Control_ Start Power Mode* and *Status_ Power Mode* communication objects. The Power Mode lets change the Setpoint Temperature and the Fan Speed within a given period.

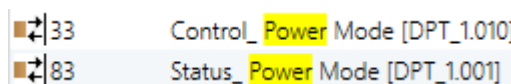

- If set to "no" the objects will not be shown.
- If set to "yes" the *Control_ Start Power Mode* and *Status_ Power Mode* objects and new parameters will appear.

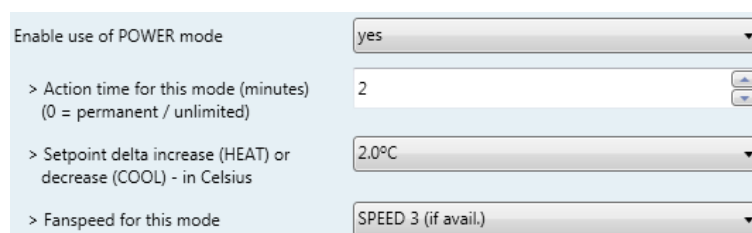

Figure 4.11 Parameter detail

- When a "1" value is sent to the *Control_* communication object Power Mode will be enabled, and the *Status_* object will return this value.

- When a "0" value is sent to the *Control_* communication object, Power Mode will be disabled, and the *Status_* object will return this value.

⚠ **Important:** This mode will ONLY work if the indoor unit is both turned on and Heat, Cool, Auto-Heat or Auto-Cool Mode.

➤ Action time for this mode (minutes):

Duration of Power Mode, in minutes, once started.

➤ Setpoint delta increase (HEAT) or decrease (COOL) – in Celsius:

Number of degrees Celsius that will increase in Heat Mode, or decrease in Cool Mode, while in Power Mode.

➤ Fan Speed for this mode:

Fan Speed that will be set in the unit while in Power Mode.

4.3.2. Enable use of ECONOMY mode

This parameter shows/hides the *Control_ Start Econo Mode* and *Status_ Econo Mode* communication objects. The Econo Mode lets change the Setpoint Temperature and the Fan Speed within a given period.

↔ 34	Control_ Econo Mode [DPT_1.010]
↔ 84	Status_ Econo Mode [DPT_1.001]

- If set to "no" the objects will not be shown.
- If set to "yes" the *Control_ Start Econo Mode* and *Status_ Econo Mode* objects and new parameters will appear.
 - When a "1" value is sent to the *Control_* communication object, EconoMode will be enabled, and the *Status_* object will return this value.
 - When a "0" value is sent to the *Control_* communication object, EconoMode will be disabled, and the *Status_* object will return this value.

⚠ **Important:** This mode will ONLY work if the indoor unit is both turned on and, in a Heat, Cool, Auto-Heat or Auto-Cool Mode.

➤ Action time for this mode (minutes):

Duration of EconoMode, in minutes, once started.

➤ Setpoint delta increase (HEAT) or decrease (COOL) – in Celsius:

Number of degrees Celsius that will increase in Heat Mode, or decrease in Cool Mode, while in EconoMode.

➤ Fan Speed for this mode:

Fan Speed that will be set in the unit while in EconoMode.

4.3.3. Enable use of ADDITIONAL HEATING mode

This parameter shows/hides the *Control_ Start Additional Heat Mode* and *Status_ Additional Heat Mode* communication objects. The Additional Heating Mode lets change the Setpoint Temperature and the Fan Speed within a given period.

↕ 35	Control_ Additional Heat [DPT_1.010]
↕ 85	Status_ Additional Heat [DPT_1.001]

- If set to **"no"** the objects will not be shown.
- If set to **"yes"** the *Control_ Start Additional Heat Mode* and *Status_ Additional Heat Mode* objects and new parameters will appear.
 - When a **"1"** value is sent to the *Control_* communication object, Additional Heating Mode will be enabled, and the *Status_* object will return this value.
 - When a **"0"** value is sent to the *Control_* communication object, Additional Heating Mode will be disabled, and the *Status_* object will return this value.

⚠ Important: This mode will ALWAYS turn on the indoor unit in Heat mode.

➤ Action time for this mode (minutes):

Duration of Additional Heating Mode, in minutes, once started.

➤ Setpoint temp for this mode (°C):

Setpoint temperature that will be applied while in Additional Heating Mode.

➤ Fan Speed for this mode:

Fan Speed that will be set in the unit while in Additional Heating Mode.

4.3.4. Enable use of ADDITIONAL COOLING mode

This parameter shows/hides the *Control_ Start Additional Cool Mode* and *Status_ Additional Cool Mode* communication objects. The Additional Heating Mode lets change the Setpoint Temperature and the Fan Speed within a given period.

↕ 36	Control_ Additional Cool [DPT_1.010]
↕ 86	Status_ Additional Cool [DPT_1.001]

- If set to **"no"** the objects will not be shown.
- If set to **"yes"** the *Control_ Start Additional Cool Mode* and *Status_ Additional Cool Mode* objects and new parameters will appear.
 - When a **"1"** value is sent to the *Control_* communication object, Additional Cooling Mode will be enabled, and the *Status_* object will return this value.
 - When a **"0"** value is sent to the *Control_* communication object, Additional Cooling Mode will be disabled, and the *Status_* object will return this value.

⚠ Important: This mode will ALWAYS turn on the indoor unit in Cool mode.

➤ Action time for this mode (minutes):

Duration of Additional Cooling Mode, in minutes, once started.

➤ Setpoint temp for this mode (°C):

Setpoint temperature that will be applied while in Additional Cooling Mode.

➤ Fan Speed for this mode:

Fan Speed that will be set in the unit while in Additional Cooling Mode.

4.4. Fan Speed Configuration dialog

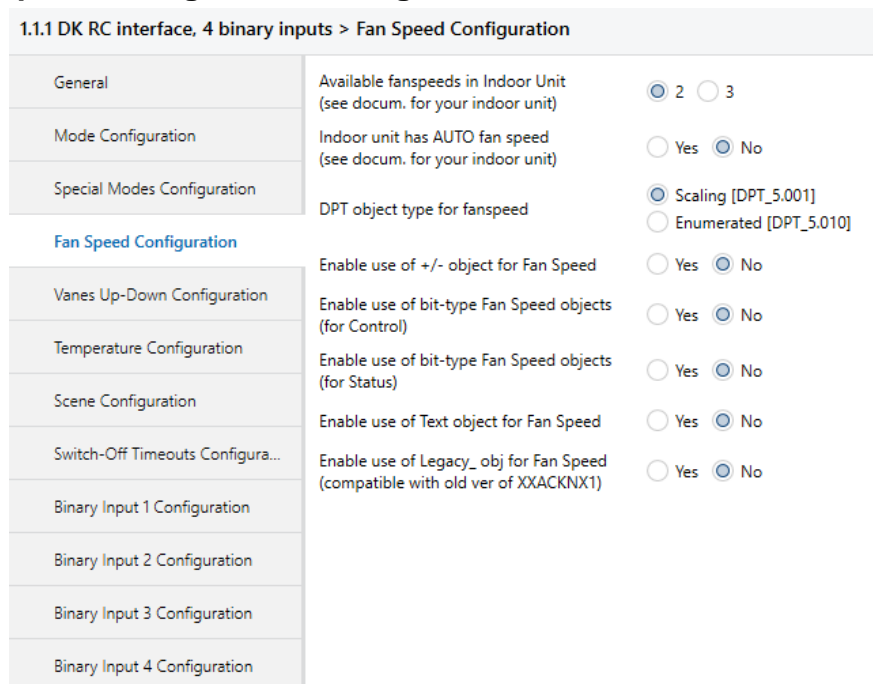

Figure 4.12 Default Fan Speed Configuration dialog

All the parameters in this section are related with the Fan Speed properties and communication objects.

4.4.1. Available fan speeds in Indoor Unit

This parameter lets you choose how many fan speeds are available in the indoor unit (2 or 3 speeds available).



Figure 4.13 Parameter detail

Changing the fan speeds will also change the fan speed byte-type object (and the bit-type objects) erasing all the group addresses associated.

⚠ Important: Read the documentation of your indoor unit to check how many fan speeds are available.

4.4.2. AUTO fan speed available in Indoor Unit

This parameter lets you enable AUTO fan speed in case this function is available in the indoor unit.

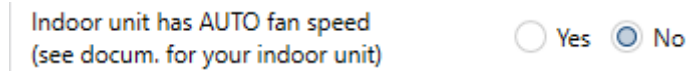

Figure 4.14 Parameter detail

By setting "YES" in this parameter, the following parameter will appear:

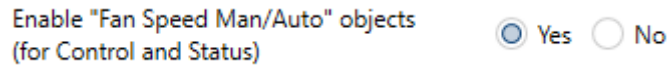
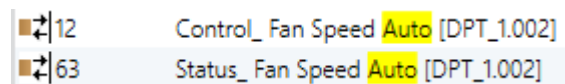

Figure 4.15 Parameter detail

By setting yes in this new parameter, two new objects will be showed. These parameters allow us to control and get the status for AUTO FAN function.



⚠ Important: Read the documentation of your indoor unit to check if AUTO fan speed function is available.

4.4.3. DPT object type for fanspeed

With this parameter is possible to change de DPT for the *Control_Fan Speed* and *Status_Fan Speed* byte-type communication objects. Datapoints Scaling (DPT_5.001) and Enumerated (DPT_5.010) can be selected.

- When **"Enumerated [DPT 5.010]"** is selected, *Control_Fan Speed* and *Status_Fan Speed* communication objects for this DPT will appear. Also, depending on the number of fan speeds selected, these objects will be different.

If this DPT is selected with 2 fan speeds:

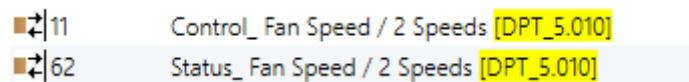

The first fan speed will be selected if a "1" is sent to the *Control_* object. The second fan speed will be selected sending a "2".

The *Status_* object will always return the value for the fan speed selected.

If this DPT is selected with 3 fan speeds:

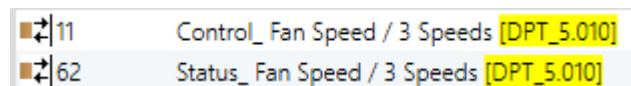

The first fan speed will be selected if a "1" is sent to the *Control_* object. The second one will be selected sending a "2", and the last one sending a "3".

The *Status_* object will always return the value for the fan speed selected.

⚠ Important: In both cases if a "0" value is sent to the *Control_* object, the minimum fan speed will be selected. If a value bigger than "2" (in case of 2 speeds) or bigger than "3" (in case of 3 fan speeds) is sent to the *Control_* object, then the maximum fan speed will be selected.

- When **"Scaling [DPT 5.001]"** is selected, *Control_Fan Speed* and *Status_Fan Speed* communication objects for this DPT will appear. Also, depending on the number of fan speeds selected, these objects will be different.

If this DPT is selected with 2 fan speeds:

↕ 11	Control_ Fan Speed / 2 Speeds [DPT_5.001]
↕ 62	Status_ Fan Speed / 2 Speeds [DPT_5.001]

When a value between **0%** and **74%** is sent to the *Control_* object the first fan speed will be selected.

When a value between **75%** and **100%** is sent to the *Control_* object, the second speed will be selected.

The *Status_* object will return a **50%** for the first fan speed, and a **100%** for the second one.

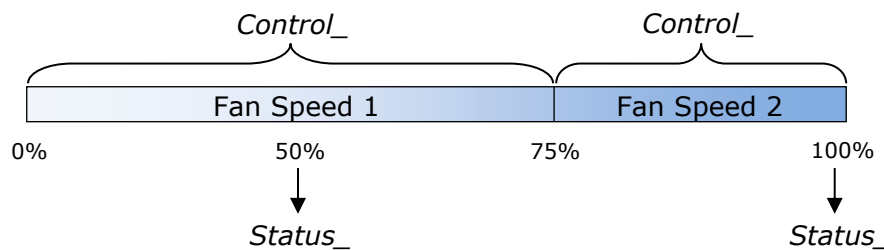

If this DPT is selected with 3 fan speeds:

↕ 11	Control_ Fan Speed / 3 Speeds [DPT_5.001]
↕ 62	Status_ Fan Speed / 3 Speeds [DPT_5.001]

When a value between **0%** and **49%** is sent to the *Control_* object the first fan speed will be selected.

When a value between **50%** and **83%** is sent to the *Control_* object, the second speed will be selected.

When a value between **84%** and **100%** is sent to the *Control_* object, the third speed will be selected.

The *Status_* object will return a **33%** when the first speed is selected, a **67%** for the second one and a **100%** for the third one.

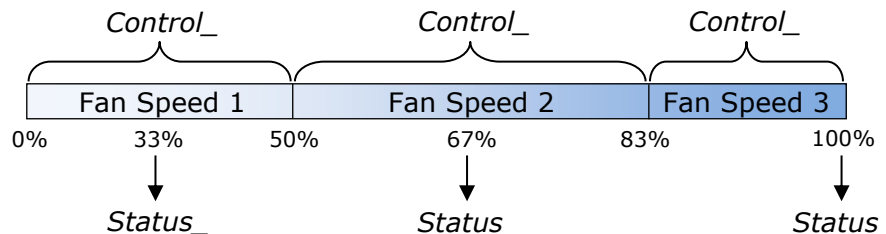

4.4.4. Enable use of +/- object for Fan Speed

This parameter shows/hides the *Control_ Fan Speed +/-* communication object which lets you increase/decrease the indoor unit fan speed by using two different datapoint types.

↕ 16	Control_ Fan Speed +/- [DPT_1.008]
------	------------------------------------

- If set to "no" the object will not be shown.

- If set to **“yes”** the *Control_ Fan Speed +/-* object and a new parameter will appear.

Enable use of +/- object for Fan Speed Yes No

> DPT type for +/- Fan Speed object 0-Decrease / 1-Increase [DPT_1.007] 0-Up / 1-Down [DPT_1.008]

> Does +/- sequence include fan speed AUTO? Yes No

> Rollover Speed at upper/lower limit (when controlling with +/- obj) Yes No

Figure 4.16 Parameter detail

- Does +/- sequence include fan speed AUTO?

This parameter allows to include the AUTO fan speed inside the sequence of fan speeds.

- DPT type for +/- Fan Speed Object

This parameter lets choose between the datapoints **0-Up / 1-Down [DPT_1.008]** and **0-Decrease / 1-Increase [DPT_1.007]** for the *Control_ Fan Speed +/-* object.

- Roll-over Speed at upper/lower limit

This parameter lets choose if roll-over will be enabled (**“yes”**) or disabled (**“no”**) for the *Control_ Fan Speed +/-* object.

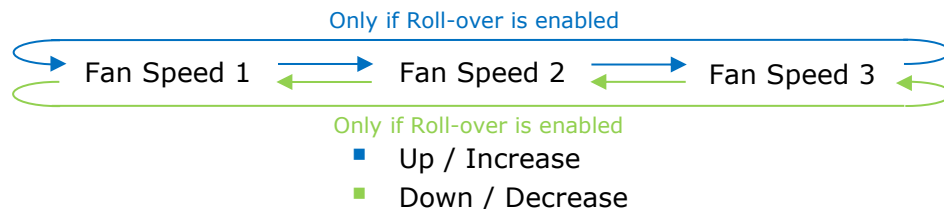

4.4.5. Enable use of bit-type Fan Speed objects (for Control)

This parameter shows/hides the bit-type *Control_ Fan Speed* objects.

<input checked="" type="checkbox"/>	13	Control_ Fan Speed 1 [DPT_1.002]
<input checked="" type="checkbox"/>	14	Control_ Fan Speed 2 [DPT_1.002]
<input checked="" type="checkbox"/>	15	Control_ Fan Speed 3 [DPT_1.002]

- If set to **“no”** the objects will not be shown.
- If set to **“yes”** the *Control_ Fan Speed* objects for Speed 1, Speed 2 and Speed 3 (if available) will appear. To activate a Fan Speed by using these objects a **“1”** value has to be sent.

4.4.6. Enable use of bit-type Fan Speed objects (for Status)

This parameter shows/hides the bit-type *Status_ Fan Speed* objects.

64	Status_ Fan Speed 1 [DPT_1.002]
65	Status_ Fan Speed 2 [DPT_1.002]
66	Status_ Fan Speed 3 [DPT_1.002]

- If set to **"no"** the objects will not be shown.
- If set to **"yes"** the *Status_ Fan Speed* objects for Speed 1, Speed 2 and Speed 3 (if available) will appear. When a Fan Speed is enabled, a **"1"** value is returned through its bit-type object.

4.4.7. Enable use of Text object for Fan Speed

This parameter shows/hides the *Status_ Fan Speed Text* communication object.

67	Status_ Fan Speed Text [DPT_16.001]
----	-------------------------------------

- If set to **"no"** the object will not be shown.
- If set to **"yes"** the *Status_ Fan Speed Text* object will appear. Also, in the parameters, will be shown two (or three, depending on the number of fan speeds selected) text fields, one for each Fan Speed, that will let modify the text string displayed by the *Status_ Fan Speed Text* when changing a fan speed.

> String when fan speed is 1	SPEED 1
> String when fan speed is 2	SPEED 2
> String when fan speed is 3	SPEED 3

Figure 4.17 Parameter detail

4.4.8. Enable use of Legacy_ obj for Fan Speed

This parameter shows/hides the *Legacy_ Fan Speed* communication object.

91	Legacy_ Fan Speed [Enumerated]
----	--------------------------------

- If set to **"no"** the object will not be shown.
- If set to **"yes"** the *Legacy_ Fan Speed* object will appear. This object lets change the indoor unit Fan Speed but it uses a different data type. It is used to maintain compatibility with old gateway models.

4.5. Vane Up-Down Configuration dialog

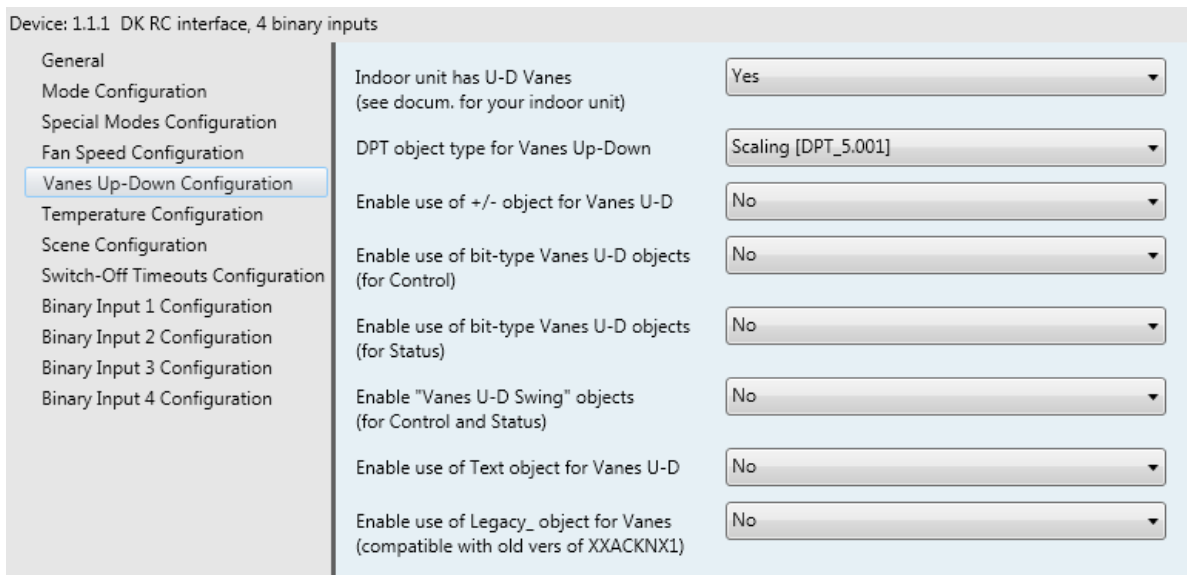

Figure 4.18 Vane Up-Down Configuration dialog

All the parameters in this section are related with the Vane Up-Down properties and communication objects.

4.5.1. Indoor unit has Up-Down Vanes

This parameter lets you choose if the unit has Up-Down Vanes available or not.

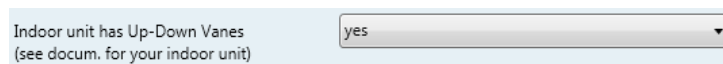

Figure 4.19 Parameter detail

- If set to “no” all the parameters and communication objects for the Up-Down Vanes will not be shown.
- If set to “yes” all the parameters and communication objects (if enabled in the parameters dialog) for the Up-Down Vanes will be shown.

⚠ Important: Read the documentation of your indoor unit to check if Up-Down Vanes are available.

4.5.2. Enable “Control_ Vane U-D Swing”

This parameter shows/hides the *Control_ Vane Up-Down Swing* and *Status_ Vane Up-Down Swing* communication object.

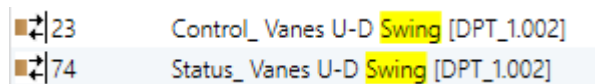

- If set to “no” the object will not be shown.
- If set to “yes” the *Control_ Vane Up-Down Swing* and *Status_ Vane Up-Down Swing* objects will appear.
 - When a “1” value is sent to the *Control_* object, the indoor unit enables the Swing function for the vanes. The *Status_* object returns a “1” value.

- When a "0" value is sent to the *Control_* object, the Swing function for the vanes stops and the indoor unit puts them to Position 1. The *Status_* object returns a "0" value.

⚠ **Important:** If a "0" value is sent to the *Control_* object while the Swing function is disabled, the value will be ignored, and no change will be applied.

4.5.3. DPT object type for Vane Up-Down

With this parameter is possible to change de DPT for the *Control_ Vane Up-Down* and *Status_ Vane Up-Down* byte-type communication objects. Datapoints Scaling (DPT_5.001) and Enumerated (DPT_5.010) can be selected.

- When "Scaling [DPT 5.001]" is selected, *Control_ Vane Up-Down* and *Status_ Vane Up-Down* communication objects for this DPT will appear.

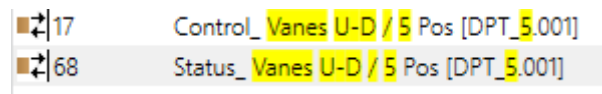

When a value between **0%** and **29%** is sent to the *Control_* object the first vane position will be selected.

When a value between **30%** and **49%** is sent to the *Control_* object, the second vane position will be selected.

When a value between **50%** and **69%** is sent to the *Control_* object, the third vane position will be selected.

When a value between **70%** and **89%** is sent to the *Control_* object, the fourth vane position will be selected.

When a value between **90%** and **100%** is sent to the *Control_* object, the fifth vane position will be selected.

The *Status_* object will return a **20%** for the first vane position, a **40%** for the second one, a **60%** for the third one, an **80%** for the fourth one and a **100%** for the fifth and last one.

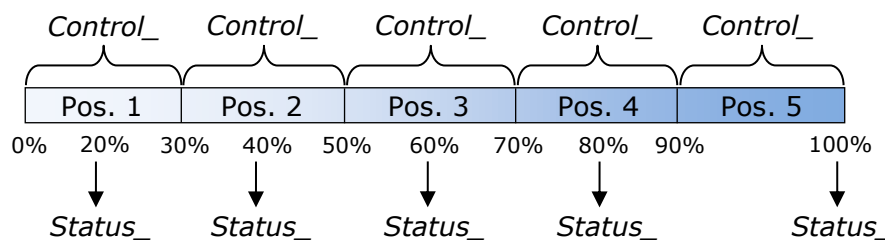

- When "Enumerated [DPT 5.010]" is selected, *Control_ Vane Up-Down* and *Status_ Vane Up-Down* communication objects for this DPT will appear.

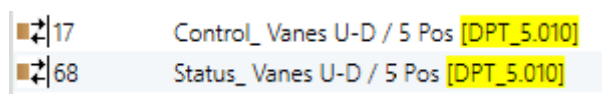

To choose a vane position, values from "1" to "5" can be sent to the *Control_* object. Each value will correspond to the position (i.e. Value "3" = Position 3).

The *Status_* object will always return the value for the vane position selected.

⚠ Important: If a "0" value is sent to the *Control_* object, the Position 1 will be selected. If a value bigger than "5" is sent to the *Control_* object, then the Position 5 will be selected.

4.5.4. Enable use of +/- obj for Vane Up-Down

This parameter shows/hides the *Control_ Vane Up-Down +/-* communication object which lets you change the indoor unit vane position by using two different datapoint types.

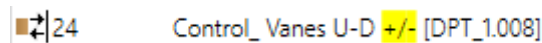

- If set to "no" the object will not be shown.
- If set to "yes" the *Control_ Vane Up-Down +/-* object and a new parameter will appear.

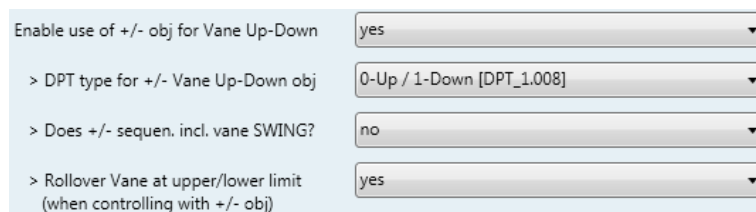

Figure 4.20 Parameter detail

➤ DPT type for +/- Vane Up-Down obj

This parameter lets choose between the datapoints **0-Up / 1-Down [DPT_1.008]** and **0-Decrease / 1-Increase [DPT_1.007]** for the *Control_ Vane Up-Down +/-* object.

➤ Does +/- sequen. incl. vane SWING?

This parameter lets you choose if SWING function is included ("yes") or not ("no") in the sequence when using *Control_ Vane Up-Down +/-* object as shown in the discontinuous segment at the picture below.

➤ Rollover Vane at upper/lower limit

This parameter lets choose if roll-over will be enabled ("yes") or disabled ("no") for the *Vane Up-Down +/-* object.

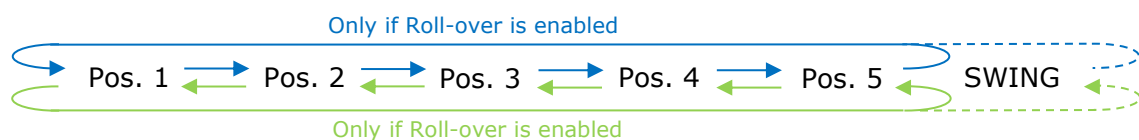

- Up / Increase
- Down / Decrease

4.5.5. Enable use of bit-type Vane U-D objects (for Control)

This parameter shows/hides the bit-type *Control_ Vane Up-Down* objects.

↔18	Control_Vanes U-D Pos 1 [DPT_1.002]
↔19	Control_Vanes U-D Pos 2 [DPT_1.002]
↔20	Control_Vanes U-D Pos 3 [DPT_1.002]
↔21	Control_Vanes U-D Pos 4 [DPT_1.002]
↔22	Control_Vanes U-D Pos 5 [DPT_1.002]

- If set to **"no"** the objects will not be shown.
- If set to **"yes"** the *Control_Vane Up-Down* objects for each Position (1 to 5) will appear. To activate a Vane Position by using these objects, a **"1"** value has to be sent.

4.5.6. Enable use of bit-type Vane U-D objects (for Status)

This parameter shows/hides the bit-type *Status_Vane Up-Down* objects.

↔69	Status_Vanes U-D Pos 1 [DPT_1.002]
↔70	Status_Vanes U-D Pos 2 [DPT_1.002]
↔71	Status_Vanes U-D Pos 3 [DPT_1.002]
↔72	Status_Vanes U-D Pos 4 [DPT_1.002]
↔73	Status_Vanes U-D Pos 5 [DPT_1.002]

- If set to **"no"** the objects will not be shown.
- If set to **"yes"** the *Status_Vane Up-Down* objects for each Position (1 to 5) will appear. When a Vane Position is enabled, a **"1"** value is returned through its bit-type object.

4.5.7. Enable use of Text object for Vane U-D

This parameter shows/hides the *Status_Vane Up-Down Text* communication object.

↔75	Status_Vanes U-D Text [DPT_16.001]
-----	------------------------------------

- If set to **"no"** the object will not be shown.
- If set to **"yes"** the *Status_Vane Up-Down Text* object will appear. Also, in the parameters will be shown six text fields, five for the Vane Position and one for the Swing function, that will let modify the text string displayed by the *Status_Vane Up-Down Text* when changing a vane position.

> String when vane U-D is in POS1	U-D POS1
> String when vane U-D is in POS2	U-D POS2
> String when vane U-D is in POS3	U-D POS3
> String when vane U-D is in POS4	U-D POS4
> String when vane U-D is in POS5	U-D POS5
> Str. when vane U-D is in SWING	U-D SWING

Figure 4.21 Parameter detail

4.5.8. Enable use of Legacy_obj for Vane U-D

This parameter shows/hides the *Legacy_Vane Up-Down* communication object.

↔92	Legacy_Vanes Up-Down [Enumerated]
-----	-----------------------------------

- If set to “no” the object will not be shown.
- If set to “yes” the *Legacy_ Vane Up-Down* object will appear. This object lets change the indoor unit Vane Position but it uses a different data type. It is used to maintain compatibility with old gateway models.

4.6. Temperature Configuration dialog

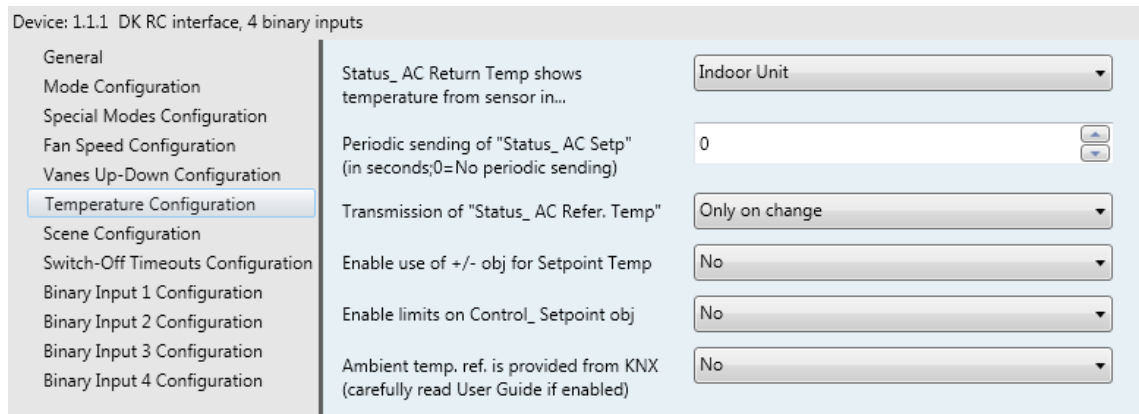
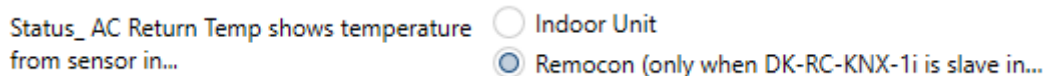

Figure 4.22 Default Temperature Configuration dialog

All the parameters in this section are related with the Temperature properties and communication objects.

4.6.1. Status_AC Return Temp shows temperature from...



This parameter allows the device to send any of the temperatures that may be available for the indoor unit. Recommended configuration is:

- Indoor unit → in any of the following cases:
 - No wired remote controller is being used
 - Wired remote controller is configured as master and the AC uses the temperature from the return path (not the remote controller temperature).
- Remocon → In case there is a wired remote controller for the AC and the indoor unit is configured to receive the temperature from the remote controller.

4.6.2. Periodic sending of “Status_ AC Setp”

This parameter lets you change the interval of time (in seconds, from 0 to 255) at the end of which the AC setpoint temperature is sent to the KNX bus. For a “0” value, the AC setpoint temperature will ONLY be sent on change. The AC setpoint temperature is sent through the communication object *Status_ AC Setpoint Temp*.

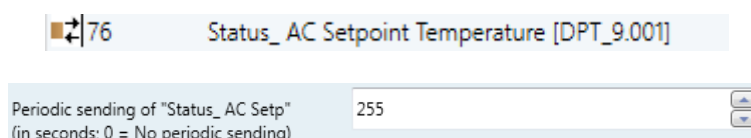

Figure 4.23 Parameter detail

△ Important: In case of working with the gateway in slave mode and the ambient temperature provided from KNX, the setpoint temperature returned from this object, will

be the one resulting from the formula shown in the section "4.6.5 Ambient temp. ref. is provided from KNX".

4.6.3. Transmission of "Status_ AC Ret Temp"

This parameter lets to you choose if the AC return temperature will be sent "only cyclically", "only on change" or "cyclically and on change". The AC return temperature is sent through the communication object *Status_ AC Return Temp*.

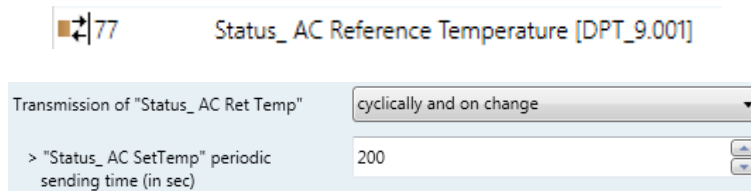

Figure 4.24 Parameter detail

➤ "Status_ AC SetTemp" periodic sending time (in sec)

This parameter will only be available for the "only cyclically" and "cyclically and on change" options, and let you change the interval of time (in seconds, from 1 to 255) at the end of which the AC return temperature is sent to the KNX bus.

4.6.4. Enable use of +/- obj for Setp Temp

This parameter shows/hides the *Control_ Setpoint Temp +/-* communication object which lets you change the indoor unit setpoint temperature by using two different datapoint types.

■ 26: Control_ Setpoint Temp +/- [DPT_1.008 - 1bit] - 0-Up;1-Down

- If set to "no" the object will not be shown.
- If set to "yes" the *Control_ Setpoint Temp +/-* object and a new parameter will appear.

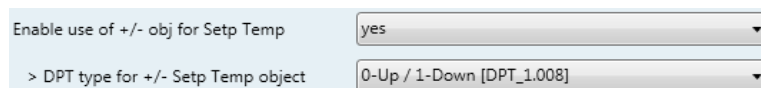
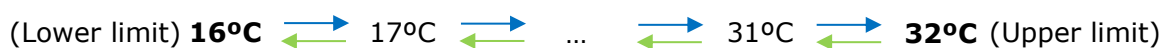

Figure 4.25 Parameter detail

➤ DPT type for +/- Setp Temp object

This parameter lets choose between the datapoints **0-Up / 1-Down [DPT_1.008]** and **0-Decrease / 1-Increase [DPT_1.007]** for the *Control_ Setpoint Temp +/-* object.



- Up / Increase
- Down / Decrease

4.6.5. Enable limits on Control_ Setpoint obj

This parameter enables to define temperature limits for the *Control_ Setpoint Temperature* object.

Enable limits on Control_Setpoint obj	yes
> Control_Set Temp Lower limit (°C)	18.0°C
> Control_Set Temp Upper limit (°C)	30.0°C

Figure 4.26 Parameter detail

- If set to **"no"** the setpoint temperature limits for the *Control_Setpoint Temperature* object will be the default: 16°C for the lower limit and 32°C for the upper limit.
- If set to **"yes"** it is possible to define temperature limits for the *Control_Setpoint Temperature* object.

➤ Control_Set Temp Lower limit (°C)

This parameter lets to define the lower limit for the setpoint temperature.

➤ Control_Set Temp Upper limit (°C)

This parameter lets to define the upper limit for the setpoint temperature.

⚠ **Important:** *If a setpoint temperature above the upper defined limit (or below the lower defined limit) is sent through the Control_Setpoint Temperature object, it will be ALWAYS applied the limit defined.*

⚠ **Important:** *When limits are enabled, any setpoint temperature sent to the AC (even through scenes, special modes, etc.) will be limited.*

⚠ **Important:** *If the gateway is slave in P1/P2 bus, it is possible to change the setpoint temperature with the master remote controller below or above the defined limits.*

4.6.6. Ambient temp. ref. is provided from KNX

This parameter shows/hides the *Control_Ambient Temperature* communication object which lets you use an ambient temperature reference provided by a KNX device.

☑ 27	Control_Ambient Temperature [DPT_9.001]
------	---

⚠ **Important:** *The Daikin indoor units has three different ways to be programmed in regards with the ambient temperature sensor, see below. This configuration must be done by a Daikin qualified technician or installer.*

- 1) The indoor unit uses its own return temperature.
- 2) The indoor unit uses its own return temperature when there is a big difference between the ambient temperature and the setpoint temperature. It uses the ambient temperature from the Master device (remote controller, or INKNXDAI001R100 device) when this difference is small.
- 3) It is only used the ambient temperature from the Master device (remote controller, or INKNXDAI001R100 device). This option is not available on all the indoor unit models.

Note that when this parameter is enabled in the INKNXDAI001R100, it may require the AC indoor unit to be programmed to work in a specific way regarding the ambient temperature sensor, in one of the three options explained above.

- If set to **"no"** the object will not be shown.

- If set to **"yes"** the *Control_ Ambient Temperature* object will appear.
 - When the INKNXDAI001R100 is **Master** in P1/P2 bus: The ambient temperature is provided from KNX. The AC indoor unit will work with this temperature as its reference temperature (it will NOT use its own return temperature). *This requires programming the AC indoor unit to work as explained in options 2) or 3) above.*
 - When the INKNXDAI001R100 is **Slave** in P1/P2 bus: The indoor unit works with its own return temperature. *This requires programming the AC indoor unit to work as explained in option 1) above.*
As in this case the AC return temperature could be different as of the KNX ambient temperature, the INKNXDAI001R100 applies a formula to compensate this difference. So, the compensated setpoint temperature sent to the AC indoor unit is the result of applying the next formula:

"AC Setp. Temp" = "AC Ret. Temp" - ("KNX Amb. Temp." - "KNX Setp. Temp")

- AC Setp. Temp: AC indoor unit setpoint temperature
- AC Ret. Temp: AC indoor unit return temperature
- KNX Amb. Temp.: Ambient temperature provided from KNX
- KNX Setp. Temp: Setpoint temperature provided from KNX

This formula ensures that INKNXDAI001R100 will send always a suitable setpoint to the AC indoor unit to reach the demanded setpoint of KNX and having always into account the ambient temperature read at KNX and the return temperature measured by the own AC indoor unit. *Note these two ambient temperatures may be different because one is measured at 1,5 meters above the ground (the one measured by the KNX sensor), and the other one is measured in the inlet pipe located in the ceiling (the one measured by Daikin).*

As an example, consider the following situation:

User wants: **19°C** ("KNX Setp. Temp.")

User sensor (a KNX sensor) reads: **21°C** ("KNX Amb Temp.")

Ambient temp. read by Daikin system is: **24°C** ("AC Ret. Temp")

In this example, the final setpoint temperature that INKNXDAI001R100 will send out to the indoor unit (shown in "Setp. Temp.") will become $24^{\circ}\text{C} - (21^{\circ}\text{C} - 19^{\circ}\text{C}) = \mathbf{22^{\circ}\text{C}}$. This is the setpoint that will actually be requested to Daikin unit.

This formula will be applied as soon as the *Control_ Setpoint Temperature* and *Control_ Ambient Temperature* objects are written at least once from the KNX installation. After that, they are kept always consistent.

Note that this formula will always drive the AC indoor unit demand in the *right* direction, regardless of the operation mode (Heat, Cool or Auto).

It also must be remarked that, if using a Daikin centralized control system for the supervision/control of multiple indoor units, it will report the actual setpoint and ambient temperature on the AC indoor units, which may be different than the ones at the KNX side.

4.7. Scene Configuration dialog

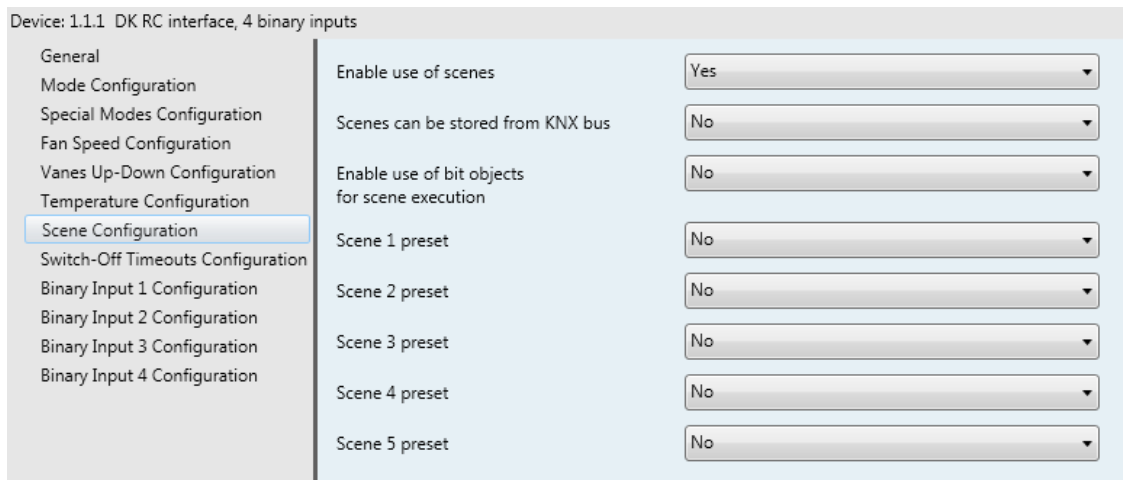

Figure 4.27 Parameter detail

All the parameters in this section are related with the Scene properties and communication objects. A scene contains values of: On/Off, Mode, Fan speed, Vane position, Setpoint Temperature and Remote Controller Disablement.

4.7.1. Enable use of scenes

This parameter shows/hides the scene configuration parameters and communication objects.

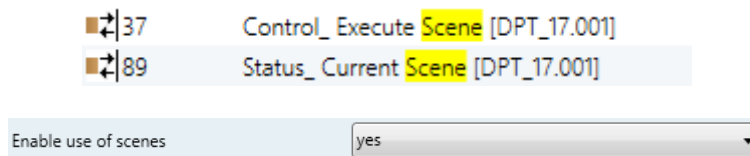
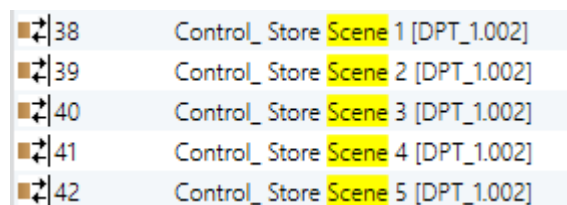

Figure 4.28 Parameter detail

- If set to **"no"** the scene parameters and communication objects will not be shown.
- If set to **"yes"** the scene parameters and communication objects will be shown. To execute a scene through the byte-type object, a value from **"0"** to **"4"** has to be sent, corresponding each one to a different scene (i.e. "0" = Scene 1;... "4" = Scene 5).

4.7.2. Scenes can be stored from KNX bus

This parameter shows/hides the *Control_ Save/Exec Scene* and all the *Control_ Store Scene* (if enabled) communication objects.



- If set to **"no"** the communication objects will not be shown.
- If set to **"yes"** the communication objects and a new parameter will appear. To store a scene through the byte-type object, a value from **"128"** to **"132"** has to be sent to the object, corresponding each one to a different scene (i.e. "128" = Scene 1;... "132" = Scene 5).

Scenes can be stored from KNX bus	yes
> Enable use of bit objects for storing scenes (from bus)	yes

Figure 4.29 Parameter detail

- Enable use of bit objects for storing scenes (from bus)

If set to **"no"** the objects will not be shown.

If set to **"yes"** the *Control_ Store Scene* objects for storing scenes will appear. To store a scene by using these objects, a **"1"** value has to be sent to the scene's object we want to store (i.e. to store scene 4, a "1" has to be sent to the *Control_ Store Scene 4* object).

4.7.3. Enable use of bit objects for scene execution

This parameter shows/hides the *Control_ Execute Scene* bit-type communication objects.

43	Control_ Execute Scene 1 [DPT_1.002]
44	Control_ Execute Scene 2 [DPT_1.002]
45	Control_ Execute Scene 3 [DPT_1.002]
46	Control_ Execute Scene 4 [DPT_1.002]
47	Control_ Execute Scene 5 [DPT_1.002]

Enable use of bit objects for scene execution	yes
---	-----

Figure 4.30 Parameter detail

- If set to **"no"** the communication objects will not be shown.
- If set to **"yes"** the communication objects will appear. To execute a scene by using these objects, a **"1"** value has to be sent to the scene's object we want to execute (i.e. to execute scene 4, a "1" has to be sent to the *Control_ Execute Scene 4* object).

4.7.4. Scene "x" preset

This parameter lets you define a preset for a scene (the following description is valid for all the scenes).

Scene 1 preset	yes (scene will NOT be modifiable from KNX bus)
----------------	---

Figure 4.31 Parameter detail

- If set to **"no"** the preset for the scene "x" will be disabled.
- If set to **"yes"** the preset will be enabled. When a scene is executed the values configured in the preset will be applied.

⚠ **Important:** If a scene's preset is enabled, will not be possible to modify (store) the scene from the KNX bus.

> Scene 1 / Value for On-Off	OFF
> Scene 1 / Value for Mode	AUTO
> Scene 1 / Value for Fan Speed	(unchanged)
> Scene 1 / Value for Vane Up-Down (if indoor unit has Vane U-D)	POSITION 4
> Scene 1 / Value for Setp Temp (°C)	25.0°C
> Scene 1 / Value for Remote Lock	(unchanged)

Figure 4.32 Parameter detail

➤ Scene "x" / Value for On-Off

This parameter lets you choose the power of the indoor unit when the scene is executed. The following options are available: **"ON"**, **"OFF"** or **"(unchanged)"**.

➤ Scene "x" / Value for Mode

This parameter lets you choose the mode of the indoor unit when the scene is executed. The following options are available: **"AUTO"**, **"HEAT"**, **"COOL"**, **"FAN"**, **"DRY"**, or **"(unchanged)"**.

➤ Scene "x" / Value for Fan Speed

This parameter lets you choose the fan speed of the indoor unit when the scene is executed. The following options are available: **"SPEED 1"**, **"SPEED 2"**, **"SPEED 3"**, or **"(unchanged)"**.

➤ Scene "x" / Value for Vane Up-Down

This parameter lets you choose the vane position of the indoor unit when the scene is executed. The following options are available: **"POSITION 1"**, **"POSITION 2"**, **"POSITION 3"**, **"POSITION 4"**, **"POSITION 5"**, **"SWING"** or **"(unchanged)"**.

➤ Scene "x" / Value for Setp Temp (°C)

This parameter lets you choose the setpoint temperature of the indoor unit when the scene is executed. The following options are available: from **"16°C"** to **"32°C"** (both included), or **"(unchanged)"**.

➤ Scene "x" / Value for Remote Lock

This parameter lets you choose the remote controller status of the indoor unit when the scene is executed. The following options are available: **"locked"**, **"unlocked"**, or **"(unchanged)"**.

⚠ **Important:** If any preset value is configured as **"(unchanged)"**, the execution of this scene will not change current status of this feature in the AC unit.

⚠ **Important:** When a scene is executed, Status_ Current Scene object shows the number of this scene. Any change in previous items does Status_ Current Scene show **"No Scene"**. Only changes on items marked as **"(unchanged)"** will not disable current scene.

4.8. Switch-Off Timeouts Configuration dialog

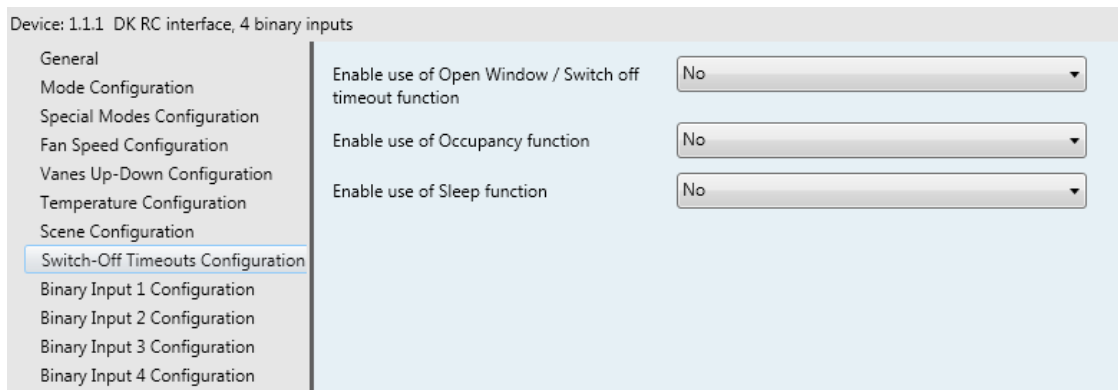
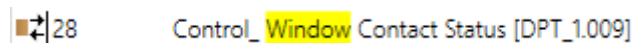

Figure 4.33 Default Switch-Off Timeouts Configuration dialog

All the parameters in this section are related with the timeout properties and communication objects.

4.8.1. Enable use of Open Window / Switch off timeout function

This parameter shows/hides the *Control_ Switch Off Timeout* communication object which lets you Start/Stop a timeout to switch off the indoor unit.



- If set to **“no”** the object will not be shown.
- If set to **“yes”** the *Control_ Switch Off Timeout* object and new parameters will appear. If a **“1”** value is sent to this object, and the indoor unit is already turned on, the switch-off timeout will begin. If a **“0”** value is sent to this object, the switch-off timeout will stop.

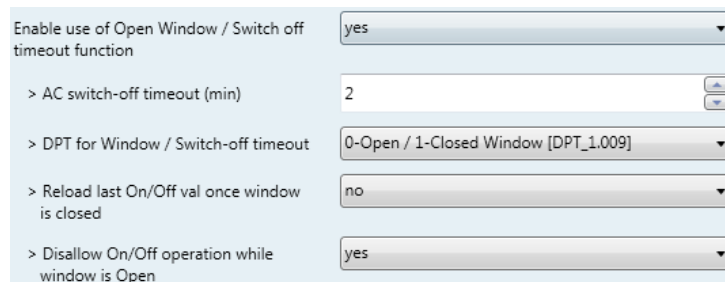

Figure 4.34 Parameter detail

➤ AC switch-off timeout (min)

This parameter lets you select how much time (in minutes) to wait before switching off the indoor unit.

➤ DPT for Window / Switch-off timeout

This parameter lets you choose between the datapoints **0-Open / 1-Closed Window [DPT_1.009]** and **0-Stop / 1-Start Timeout [DPT_1.010]** for the *Control_ Switch Off Timeout*.

➤ Disallow On/Off operation while window is Open

If set to **“no”**, On/Off commands while the window is open will be accepted.

- If a "1" value is sent to the *Control_ Switch Off Timeout* object the switch-off timeout period will begin again.
- If a "0" value is sent to the *Control_ Switch Off Timeout* object, no action will be performed.

If set to "yes", On/Off commands, while the window is open, will be saved (but not applied). These commands will be used in the next parameter if set to "yes".

➤ Reload last On/Off val once window is closed?

If set to "no", once the switch-off timeout is stopped, any value will be reloaded.

If set to "yes", once the switch-off timeout is stopped, the last On/Off value sent will be reloaded.

- If a "1" value is sent to the *Control_ Switch Off Timeout* object after the timeout period, the indoor unit will **turn on**.
- If a "0" value is sent to the *Control_ Switch Off Timeout* after the timeout period, no action will be performed.

4.8.2. Enable use of Occupancy function

This parameter shows/hides the *Control_ Occupancy* communication object which lets you apply different parameters to the indoor unit depending on the presence/no presence in the room.

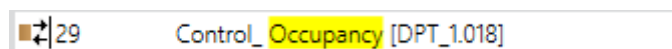

- If set to "no" the object will not be shown.
- If set to "yes" the *Control_ Occupancy* object and new parameters will appear. If a "0" value is sent to this object (no room occupancy), the timeout will begin. If a "1" value is sent to this object, the timeout will stop.

Enable use of Occupancy function	yes
> Timeout to apply action (minutes)	2
> Action after timeout elapsed	Apply Preset Delta

Figure 4.35 Parameter detail

➤ Timeout to apply action (minutes)

This parameter lets you choose how much time to wait (in minutes) before executing the action specified in the next parameter ("Action after timeout elapsed").

➤ Action after timeout elapsed

When **Switch-Off** is selected, once the timeout has elapsed, the indoor unit will be turned off.

When **Apply Preset Delta** is selected, once the timeout has elapsed, a delta temperature will be applied to save energy (decreasing the setpoint when in Heat mode or increasing the setpoint when in Cool mode). Also new parameters will appear.

> Temp delta decrease (HEAT) or increase (COOL) (°C)	2.0°C
> Enable secondary timeout	yes

Figure 4.36 Parameter detail

- Temp delta decreases (HEAT) or increase (COOL) (°C)

This parameter lets configure the delta temperature (increase or decrease) that will be applied when the timeout has elapsed.

⚠ **Important:** When there is occupancy again after the application of a delta, the same delta will be applied inversely. (i.e. In a room with AC in cool mode and 25°C setpoint temperature, a +2°C delta is applied after the occupancy timeout, setting the setpoint at 27°C because there is no occupancy in the room. If the setpoint is raised to 29°C during that period, when the room is occupied again, a -2°C delta will be applied and the final setpoint temperature will then be 27°C).

- Enable secondary timeout

If set to "no" nothing will be applied.

If set to "yes", a new timeout will be enabled, and two new parameters will appear.

> Timeout to apply action (min)	2
> Action after timeout elapsed	Apply Preset Delta
> Temp delta dec (HEAT) / or inc (COOL) (°C)	2.0°C

Figure 4.37 Parameter detail

- Timeout to apply action (minutes)

This parameter lets you choose how much time to wait (in minutes) before executing the action specified in the next parameter ("Action after timeout elapsed"). This time is considered as a part of the occupancy.

- Action after timeout elapsed

When **Switch-Off** is selected, once the timeout has elapsed, the indoor unit will turn off.

When **Apply Preset Delta** is selected, once the timeout configured is extinguished, a delta temperature will be applied (decreasing the setpoint when in Heat mode or increasing the setpoint when in Cool mode). Also new parameters will appear.

- Temp delta decreases (HEAT) or increase (COOL) (°C)

This parameter lets configure the delta temperature that will be applied when the timeout is extinguished.

⚠ **Important:** When there is occupancy again after the application of a delta, the same delta will be applied inversely as explained above.

- Disallow On/Off operation while not Occupied

If set to "no", On/Off commands while the non-occupancy period will be accepted.

If set to "yes", once **Switch-Off** action has been executed, On/Off commands will be saved (but not applied). These commands will be used in the next parameter if set to "yes".

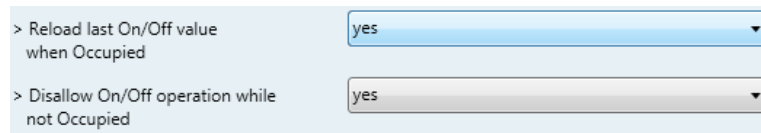

Figure 4.38 Parameter detail

Consider that the countdown time (transitional time between occupancy and non-occupancy) is considered as a part of the occupancy status as explained before.

➤ Reload last On/Off value when Occupied

If set to "no", once the switch-off timeout has elapsed, any value will be reloaded.

If set to "yes", once the switch-off timeout has elapsed, the last On/Off value will be reloaded.

- If a "1" value is sent to the *Control_ Switch Off Timeout* object after the timeout period, the indoor unit will **turn on**.
- If a "0" value is sent to the *Control_ Switch Off Timeout* after the timeout period, no action will be performed.

4.8.3. Enable use of SLEEP timeout

This parameter shows/hides the *Control_ Start Sleep Timeout* communication object which lets you start a timeout to automatically turn off the indoor unit.

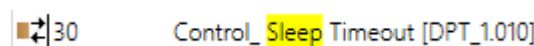

- If set to "no" the object will not be shown.
- If set to "yes" the *Control_ Start Sleep Timeout* object and a new parameter will appear. If a "1" value is sent to this object the switch-off timeout will begin. If a "0" value is sent to this object, the switch-off timeout will stop.

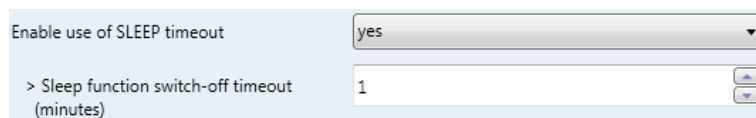

Figure 4.39 Parameter detail

➤ Timeout to apply action (minutes)

This parameter lets you select how much time (in minutes) to wait before switching off the AC unit.

4.9. Binary Input “x” Configuration dialog

Device: 1.1.1 DK RC interface, 4 binary inputs

General
Mode Configuration
Special Modes Configuration
Fan Speed Configuration
Vanes Up-Down Configuration
Temperature Configuration
Scene Configuration
Switch-Off Timeouts Configuration
Binary Input 1 Configuration
Binary Input 2 Configuration
Binary Input 3 Configuration
Binary Input 4 Configuration

Enable use of Input 1: Yes

> Contact type: NO: Normally Open

> Debounce time: 50 ms

> Disabling function: No

> Function: Switching

> Send telegram after bus recovery: No action

> Value on raising edge (contact activated): No action

> Value on falling edge (contact deactivated): No action

> Cyclical sending: Never

Figure 4.40 Binary Input Configuration dialog

All the parameters in this section are related with the binary inputs properties and communication objects.

4.9.1. Enable use of Input “x”

This parameter enables the use of the Input “x” and shows/hides the *Status_Inx* communication object(s) which will act as configured in the “Function” parameter.

↕ 93	Status_In1 - Switching [DPT_1.001]
↕ 95	Status_In2 - Switching [DPT_1.001]
↕ 97	Status_In3 - Switching [DPT_1.001]
↕ 99	Status_In4 - Switching [DPT_1.001]

- If set to “no” the objects will not be shown.
- If set to “yes” the *Status_Inx* object(s) and new parameters will appear.

4.9.2. Contact type

This parameter lets choose the behavior that will have the binary input depending on if the contact is normally open or normally closed.

- There are two possible options to configure the contact type: “**NO: Normally Open**” and “**NC: Normally Closed**”.

4.9.3. Debounce time

This parameter lets choose a debounce time (in milliseconds) that will be applied to the contact.

4.9.4. Disabling function

This parameter shows/hides the *Control_Disable Input x* communication object which will let disable/enable the input x.

↕|47: Control_Disable Input 1 [DPT_1.002 - 1bit] - 0-False;1-True

47: Control_Disable Input 1 [DPT_1.003 - 1bit] - 0-Disable;1-Enable

- If set to "no" any object will be shown.
- When "DPT 1.003: 0-Disable; 1-Enable" is selected, the input can be disabled using the value "0" and enabled using the value "1".
- When "DPT 1.002: 1-True (Disable); 0-False (Enable)" is selected, the input can be disabled using the value "1" and enabled using the value "0".

4.9.5. Function

This parameter lets choose the function that will have the binary input. There are 7 different functions available: Switching, Dimming, Shutter/Blind, Value, Execute Scene (internal), Occupancy (internal) and Window Contact (internal).

- When "Switching" is selected the communication object and new parameters for the Input "x" will appear as shown below.

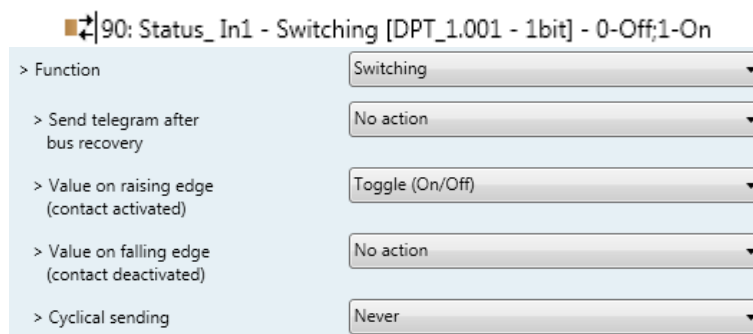

Figure 4.41 Parameter detail

➤ Send telegram after bus recovery

This parameter lets select if the Binary Input "x" will send a telegram, or not, after a bus recovery, and the type of telegram sent (if enabled).

- When "No action" is selected, no telegram will be sent after a bus recovery.
- When "Current status" is selected, the binary input will send a telegram with its current status after a bus recovery. Also a new parameter will appear (see below).
- When "On" is selected, the binary input will send a telegram with a "1" value after a bus recovery. Also a new parameter will appear (see below).
- When "Off" is selected, the binary input will send a telegram with a "0" value after a bus recovery. Also a new parameter will appear (see below).

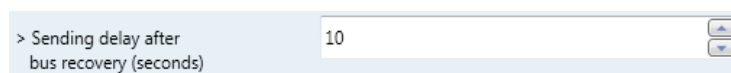

Figure 4.42 Parameter detail

➤ Sending delay after a bus recovery (seconds)

This parameter lets configure a delay (in seconds) that will be applied after a bus recovery and, after which, a telegram will be sent.

➤ Value on rising edge

This parameter lets select the value that the Binary Input "x" will send on a rising edge (contact activated).

- When **"On"** is selected, the binary input will always send telegrams with a **"1"** value.
- When **"Off"** is selected, the binary input will always send telegrams with a **"0"** value.
- When **"Toggle (On/Off)"** is selected, the binary input will send a **"1"** value after a **"0"** value and viceversa.
- When **"No action"** is selected, the binary input will not perform any action.

➤ Value on falling edge

This parameter lets select the value that the Binary Input "x" will send on a falling edge (contact deactivated).

- When **"On"** is selected, the binary input will always send telegrams with a **"1"** value.
- When **"Off"** is selected, the binary input will always send telegrams with a **"0"** value.
- When **"Toggle (On/Off)"** is selected, the binary input will send a **"1"** value after a **"0"** value and viceversa.
- When **"No action"** is selected, the binary input will not perform any action.

➤ Cyclical sending

This parameter lets enable/disable cyclical sending when a determined condition is met.

- When **"When output value is On"** is selected, everytime a **"1"** value is sent, it will be sent cyclically. Also a new parameter will appear (see below).
- When **"When output value is Off"** is selected, everytime a **"0"** value is sent, it will be sent cyclically. Also a new parameter will appear (see below).
- When **"Always"** is selected, the binary input will send any value cyclically. Also a new parameter will appear (see below).
- When **"Never"** is selected, cyclical sending will be disabled.

➤ Period for cyclical sending (seconds)

This parameter lets configure a time (in seconds) for the cyclical sending.



Figure 4.43 Parameter detail

- When **"Dimming"** is selected the communication objects and new parameters for the Input "x" will appear as shown below.
-

- 92: Status_In2 - Dimming - On/Off [DPT_1.001 - 1bit] - 0-Off;1-On
- 93: Status_In2 - Dimming - Step(%) [DPT_3.007 - 4bit] - Dimming step

> Function	Dimming
> Send telegram after bus recovery	No action
> Mode for short (long) operation	Toggle: On/Off (increase/decrease)
> Increasing step	+ 100 %
> Decreasing step	- 100 %
> Short/long operation limit (x100ms)	10
> Cyclical sending period (x100ms) (0-No cyclical sending)	0

Figure 4.44 Parameter detail

➤ Send telegram after bus recovery

This parameter lets select if the Binary Input "x" will send a telegram, or not, after a bus recovery, and the type of telegram sent (if enabled).

- When **"No action"** is selected, no telegram will be sent after a bus recovery.
- When **"On"** is selected, the binary input will send a telegram with a **"1"** value after a bus recovery. Also a new parameter will appear (see below).
- When **"Off"** is selected, the binary input will send a telegram with a **"0"** value after a bus recovery. Also a new parameter will appear (see below).

> Sending delay after bus recovery (seconds)	10
--	----

Figure 4.45 Parameter detail

➤ Sending delay after a bus recovery (seconds)

This parameter lets configure a delay (in seconds) that will be applied after a bus recovery and, after which, a telegram will be sent.

➤ Mode for short (long) operation

This parameter lets select the value that the Binary Input "x" will send on a rising edge (contact activated), for a short and a long operation.

- When **"On (increase)"** is selected, the binary input will always send telegrams with a **"1"** value for a short operation, and an **"increase step"** for a long operation.
- When **"Off (decrease)"** is selected, the binary input will always send telegrams with a **"0"** value for a short operation, and an **"decrease step"** for a long operation.
- When **"Toggle: On/Off (increase/decrease)"** is selected:

- For the short operation the binary input will send a "1" value after a "0" value and viceversa.
- For the long operation the binary input will send an "increase step" after a "decrease step" and viceversa.

⚠ **Important:** Note that the first long operation in toggle depends on the last short operation, meaning that after a "1" value will be sent a "decrease step" and after a "0" value will be sent an "increase step".

⚠ **Important:** The time period between a short and a long operation is defined in the parameter "Short/long operation limit (x100ms)".

➤ Increasing step

This parameter lets select the increasing step value (in %) that will be sent for a long operation.

➤ Decreasing step

This parameter lets select the decreasing step value (in %) that will be sent for a long operation.

➤ Short/long operation limit (x100ms)

This parameter lets introduce the time period difference for the short and the long operation.

➤ Cycl. send. period in long oper. (x100ms)

This parameter lets configure a time (in seconds) for the cyclical sending of a long operation.

- When "Shutter/Blind" is selected the communication objects and new parameters for the Input "x" will appear as shown below.

- 94: Status_In3 - Shut/Blind - Step [DPT_1.007 - 1bit] - 0-Step Up;1-Step Down
- 95: Status_In3 - Shut/Blind - Move [DPT_1.008 - 1bit] - 0-Move Up;1-Move Down

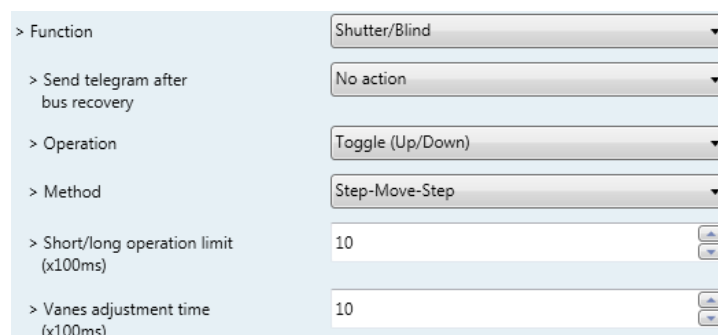

Figure 4.46 Parameter detail

➤ Send telegram after bus recovery

This parameter lets select if the Binary Input "x" will send a telegram, or not, after a bus recovery and the type of telegram sent (if enabled).

- When **"No action"** is selected, no telegram will be sent after a bus recovery.
- When **"Move Up"** is selected, the binary input will send a telegram with a **"0"** value after a bus recovery. Also a new parameter will appear (see below).
- When **"Move Down"** is selected, the binary input will send a telegram with a **"1"** value after a bus recovery. Also a new parameter will appear (see below).

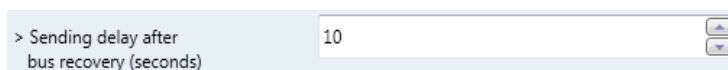

Figure 4.47 Parameter detail

➤ Sending delay after a bus recovery (seconds)

This parameter lets configure a delay (in seconds) that will be applied after a bus recovery and, after which, a telegram will be sent.

➤ Operation

This parameter lets select the value that the Binary Input "x" will send on a rising edge (contact activated).

- When **"Up"** is selected, the binary input will always send telegrams with a **"0"**.
- When **"Down"** is selected, the binary input will always send telegrams with a **"1"** value.
- When **"Toggle (Up/Down)"** is selected the binary input will send a **"0"** value after a **"1"** value and viceversa.

➤ Method

This parameter lets select the working method for the shutter/blind.

- When **"Step-Move-Step"** is selected: On a rising edge (contact activated) a step/stop telegram will be sent and will begin a time called **T1**. If a falling edge occurs (contact deactivated) during the **T1**, no action will be performed.

If the rising edge is maintained longer than **T1**, a move telegram will be sent and will start a time called **T2**. If a falling edge occurs during the **T2**, a step/stop telegram will be sent. If a falling edge occurs after **T2** no action will be performed.

- When **"Move-Step"** is selected: On a rising edge a move telegram will be sent and will begin the **T2** time. If a falling edge occurs during the **T2**, a step/stop telegram will be sent. If a falling edge occurs after **T2** no action will be performed.

⚠ **Important:** The **T1** time must be defined in the "Short/long operation limit (x100ms)" parameter. Also, the **T2** time must be defined in the "Vanes adjustment time (x100ms)" parameter.

➤ Short/long operation limit (x100ms)

This parameter lets introduce the time difference for the short and the long operation (T1 time).

➤ Vanes adjustment time (x100ms)

This parameter lets introduce the time for the vanes adjustment/blind movement (T2 time).

- When **"Value"** is selected the communication objects and new parameters for the Input "x" will appear as shown below.

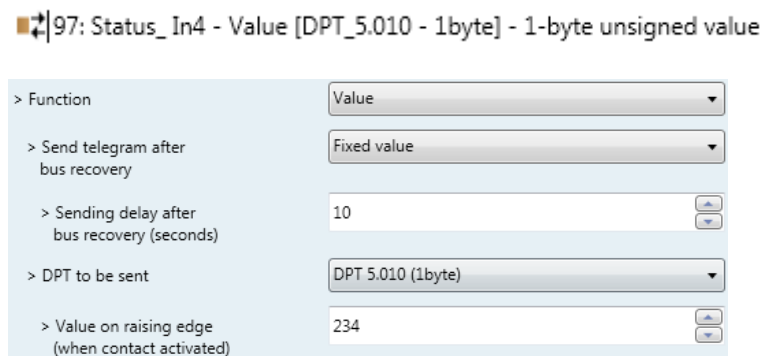

Figure 4.48 Parameter detail

➤ Send telegram after bus recovery

This parameter lets select if the Binary Input "x" will send a telegram, or not, after a bus recovery and the type of telegram sent (if enabled).

- When **"No action"** is selected, no telegram will be sent after a bus recovery.
- When **"Fixed value"** is selected, the binary input will send a telegram with the same value configured in the "Value on rising edge" parameter. Also a new parameter will appear (see below).

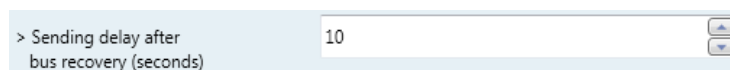

Figure 4.49 Parameter detail

➤ Sending delay after a bus recovery (seconds)

This parameter lets configure a delay (in seconds) that will be applied after a bus recovery and, after which, a telegram will be sent.

➤ DPT to be sent

This parameter lets select the DPT type for the value that will be defined in the next parameter. This value will be sent on a rising edge (contact activated).

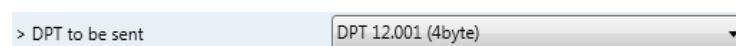
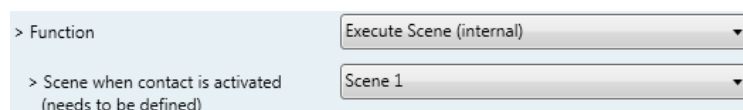

Figure 4.50 Parameter detail

➤ Value on rising edge (when contact activated)

This parameter lets define a value for the DTP type configured in the "DPT to be sent" parameter. This value will be sent on a rising edge (contact activated).

- When **"Execute Scene (internal)"** is selected, the binary input "x" will activate the scene defined in the next parameter, on a rising edge (contact activated).



The screenshot shows a configuration interface with two dropdown menus. The first dropdown is labeled '> Function' and is set to 'Execute Scene (internal)'. The second dropdown is labeled '> Scene when contact is activated (needs to be defined)' and is set to 'Scene 1'.

Figure 4.51 Parameter detail

➤ Scene when contact is activated

This parameter lets choose the scene that will be activated on a rising edge. This scene MUST be defined in the "Scene Configuration" dialog as a preset.

- When "**Occupancy (internal)**" is selected, the binary input "x" will have the same behavior as configured in the parameter "Enable use of Occupancy function" inside the "Switch-Off Timeouts Configuration" dialog.

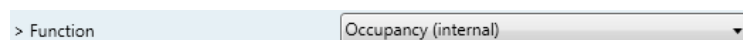

The screenshot shows a configuration interface with a dropdown menu labeled '> Function' set to 'Occupancy (internal)'.

Figure 4.52 Parameter detail

- When "**Window Contact (internal)**" is selected, the binary input "x" will have the same behavior as configured in the parameter "Enable use of Open Window / Switch off timeout function" inside the "Switch-Off Timeouts Configuration" dialog.



The screenshot shows a configuration interface with a dropdown menu labeled '> Function' set to 'Window Contact (internal)'.

Figure 4.53 Parameter detail

5. Specifications

Dimensions:	71 X 71 X 27 mm
Enclosure	Plastic, type ABS (UL 94 V-0) White, RAL 9010
Weight:	70 g
KNX current consumption:	5 mA
P1-P2 Bus current consumption:	45 mA
Operating Temperature:	-25 . . . 60°C
Stock Temperature:	-40 . . . 85°C
Isolation voltage:	2500 V
Binary inputs	4 x Potential-free binary inputs. Signal cable length: 5m unshielded, may be extended up to 20m with twisted. Compliant with the following standards: IEC61000-4-2: level 4 - 15kV (air discharge) - 8kV (contact discharge) MIL STD 883E-Method 3015-7: class3B

6. AC Unit Types compatibility.

A list of Daikin indoor unit models compatible with INKNXDAl001R100 and their available features can be found in:

https://www.intesis.com/docs/compatibilities/inxxx dai001rx00_compatibility

7. Error Codes

Error Code KNX Object	Error in Remote Controller	Error category	Error Description
17	A0	Indoor Unit	External protection devices activated
18	A1		Indoor unit PCB assembly failure
19	A2		Interlock error for fan
20	A3		Drain level system error
21	A4		Temperature of heat exchanger (1) error
22	A5		Temperature of heat exchanger (2) error
23	A6		Fan motor locked, overload, over current
24	A7		Swing flap motor error
25	A8		Overcurrent of AC input
26	A9		Electronic expansion valve drive error
27	AA		Heater overheat
28	AH		Dust collector error / No-maintenance filter error
30	AJ		Capacity setting error (indoor)
31	AE		Shortage of water supply
32	AF		Malfunctions of a humidifier system (water leaking)
33	C0		Malfunctions in a sensor system
36	C3		Sensor system of drain water error
37	C4		Heat exchanger (1) (Liquid pipe) thermistor system error
38	C5		Heat exchanger (1) (Gas pipe) thermistor system error
39	C6		Sensor system error of fan motor locked, overload
40	C7		Sensor system of swing flag motor error
41	C8		Sensor system of over-current of AC input
42	C9		Suction air thermistor error
43	CA		Discharge air thermistor system error
44	CH		Contamination sensor error
45	CC		Humidity sensor error
46	CJ		Remote control thermistor error
47	CE		Radiation sensor error
48	CF	High pressure switch sensor	
49	E0	Outdoor Unit	Protection devices activated
50	E1		Outdoor unit PCB assembly failure
52	E3		High pressure switch (HPS) activated
53	E4		Low pressure switch (LPS) activated
54	E5		Overload of inverter compressor motor
55	E6		Over current of STD compressor motor
56	E7		Overload of fan motor / Over current of fan motor
57	E8		Over current of AC input
58	E9		Electronic expansion valve drive error
59	EA		Four-way valve error
60	EH		Pump motor over current
61	EC		Water temperature abnormal
62	EJ		(Site installed) Protection device activated
63	EE		Malfunctions in a drain water
64	EF		Ice thermal storage unit error
65	H0		Malfunctions in a sensor system
66	H1		Air temperature thermistor error
67	H2		Sensor system of power supply error
68	H3		High Pressure switch is faulty
69	H4		Low pressure switch is faulty
70	H5		Compressor motor overload sensor is abnormal
71	H6		Compressor motor over current sensor is abnormal
72	H7		Overload or over current sensor of fan motor is abnormal
73	H8		Sensor system of over-current of AC input
74	H9		Outdoor air thermistor system error
75	HA		Discharge air thermistor system error
76	HH		Pump motor sensor system of over current is abnormal
77	HC		Water temperature sensor system error
79	HE		Sensor system of drain water is abnormal
80	HF		Ice thermal storage unit error (alarm)
81	F0		No.1 and No.2 common protection device operates.
82	F1		No.1 protection device operates.
83	F2	No.2 protection device operates	
84	F3	Discharge pipe temperature is abnormal	
87	F6	Temperature of heat exchanger(1) abnormal	
91	FA	Discharge pressure abnormal	
92	FH	Oil temperature is abnormally high	
93	FC	Suction pressure abnormal	
95	FE	Oil pressure abnormal	
96	FF	Oil level abnormal	
97	J0	Sensor system error of refrigerant temperature	
98	J1	Pressure sensor error	
99	J2	Current sensor error	

100	J3		Discharge pipe thermistor system error
101	J4		Low pressure equivalent saturated temperature sensor system error
102	J5		Suction pipe thermistor system error
103	J6		Heat exchanger(1) thermistor system error
104	J7		Heat exchanger(2) thermistor system error
105	J8		Oil equalizer pipe or liquid pipe thermistor system error
106	J9		Double tube heat exchanger outlet or gas pipe thermistor system error
107	JA		Discharge pipe pressure sensor error
108	JH		Oil temperature sensor error
109	JC		Suction pipe pressure sensor error
111	JE		Oil pressure sensor error
112	JF		Oil level sensor error
113	L0		Inverter system error
116	L3		Temperature rise in a switch box
117	L4		Radiation fin (power transistor) temperature is too high
118	L5		Compressor motor grounded or short circuit, inverter PCB fault
119	L6		Compressor motor grounded or short circuit, inverter PCB fault
120	L7		Over current of all inputs
121	L8		Compressor over current, compressor motor wire cut
122	L9		Stall prevention error (start-up error) Compressor locked, etc.
123	LA		Power transistor error
125	LC		Communication error between inverter and outdoor control unit
129	P0		Shortage of refrigerant (thermal storage unit)
130	P1		Power voltage imbalance, open phase
132	P3		Sensor error of temperature rise in a switch box
133	P4		Radiation fin temperature sensor error
134	P5		DC current sensor system error
135	P6		AC or DC output current sensor system error
136	P7		Total input current sensor error
142	PJ		Capacity setting error (outdoor)
145	U0	System	Low pressure drop due to insufficient refrigerant or electronic expansion valve error, etc.
146	U1		Reverse phase, Open phase
147	U2		Power voltage failure / Instantaneous power failure
148	U3		Failure to carry out check operation, transmission error
149	U4		Communication error between indoor unit and outdoor unit, communication error between outdoor unit and BS unit
150	U5		Communication error between remote control and indoor unit / Remote control board failure or setting error for remote control
151	U6		Communication error between indoor units
152	U7		Communication error between outdoor units / Communication error between outdoor unit and ice thermal storage unit
153	U8		Communication error between main and sub remote controllers (sub remote control error) / Combination error of other indoor unit / remote control in the same system (model)
154	U9		Communication error between other indoor unit and outdoor unit in the same system / Communication error between other BS unit and indoor/outdoor unit
155	UA		Combination error of indoor/BS/outdoor unit (model, quantity, etc.), setting error of spare parts PCB when replaced
156	UH		Improper connection of transmission wiring between outdoor and outdoor unit outside control adaptor
157	UC		Centralized address duplicated
158	UJ		Attached equipment transmission error
159	UE		Communication error between indoor unit and centralized control device
160	UF		Failure to carry out check operation Indoor-outdoor, outdoor-outdoor communication error, etc.
209	60	Others	All system error
210	61		PC board error
211	62		Ozone density abnormal
212	63		Contamination sensor error
213	64		Indoor air thermistor system error
214	65		Outdoor air thermistor system error
217	68		HVU error (Ventiair dust-collecting unit)
219	6A		Dumper system error
220	6H		Door switch error
221	6C		Replace the humidity element
222	6J		Replace the high efficiency filter
223	6E		Replace the deodorization catalyst
224	6F		Simplified remote controller error
226	51		Fan motor of supply air over current or overload
227	52		Fan motor of return air over current / Fan motor of return air overload
228	53		Inverter system error (supply air side)
229	54		Inverter system error (return air side)
241	40		Humidifying valve error
242	41		Chilled water valve error
243	42		Hot water valve error
244	43	Heat exchanger of chilled water error	
245	44	Heat exchanger of hot water error	
-1	N/A	INKNXDAI001R100	Error in the communication of INKNXDAI001R100 device with the AC unit

In case you detect an error code not listed, contact your nearest Daikin technical support service for more information on the error meaning.

Appendix A – Communication Objects Table

TOPIC	OBJECT NUMBER	NAME	LENGTH	DATAPOINT TYPE		FLAGS				FUNCTION
				DPT_NAME	DPT_ID	R	W	T	U	
On/Off	0	Control_ On/Off	1 bit	DPT_Switch	1.001		W	T		0 - Off; 1-On
Mode	1	Control_ Mode	1 byte	DPT_HVACContrMode	20.105		W	T		0 - Auto; 1 - Heat; 3 - Cool; 9 - Fan; 14 - Dry
	2	Control_ Mode Cool/Heat	1 bit	DPT_Heat/Cool	1.100		W	T		0 - Cool; 1 - Heat
	3	Control_ Mode Cool & On	1 byte	DPT_Scaling	5.001		W	T		0% - Off; 0.1%-100% - On + Cool
	4	Control_ Mode Heat & On	1 byte	DPT_Scaling	5.001		W	T		0% - Off; 0.1%-100% - On + Heat
	5	Control_ Mode Auto	1 bit	DPT_Bool	1.002		W	T		1 - Auto
	6	Control_ Mode Heat	1 bit	DPT_Bool	1.002		W	T		1 - Heat
	7	Control_ Mode Cool	1 bit	DPT_Bool	1.002		W	T		1 - Cool
	8	Control_ Mode Fan	1 bit	DPT_Bool	1.002		W	T		1 - Fan
	9	Control_ Mode Dry	1 bit	DPT_Bool	1.002		W	T		1 - Dry
	10	Control_ Mode -/+	1 bit	DPT_Step	1.007		W			0 - Decrease; 1 - Increase
Control_ Mode +/-		1 bit	DPT_UpDown	1.008		W			0 - Up; 1 - Down	
Fan Speed	11	Control_ Fan Speed / 2 Speeds	1 byte	DPT_Scaling	5.001		W	T		0%-74% - Speed 1; 75%-100% - Speed 2
		Control_ Fan Speed / 3 Speeds	1 byte	DPT_Scaling	5.001		W	T		0%-49% - Speed 1; 50%-83% - Speed 2; 84%-100% Speed 3
		Control_ Fan Speed / 2 Speeds	1 byte	DPT_Enumerated	5.010		W	T		1 - Speed 1; 2 - Speed 2
		Control_ Fan Speed / 3 Speeds	1 byte	DPT_Enumerated	5.010		W	T		1 - Speed 1; 2 - Speed 2; 3 Speed 3
	12	Control_ Fan Speed Auto	1 bit	DPT_Bool	1.002		W	T		1 - Set AUTO

	13	Control_ Fan Speed 1	1 bit	DPT_Bool	1.002		W	T	1 - Fan Speed 1
	14	Control_ Fan Speed 2	1 bit	DPT_Bool	1.002		W	T	1 - Fan Speed 2
	15	Control_ Fan Speed 3	1 bit	DPT_Bool	1.002		W	T	1 - Fan Speed 3
	16	Control_ Fan Speed -/+	1 bit	DPT_Step	1.007		W	T	0 - Decrease; 1 - Increase
		Control_ Fan Speed +/-	1 bit	DPT_UpDown	1.008		W	T	0 - Up; 1 - Down
Vanes	17	Control_ Vane U-D / 5 pos	1 byte	DPT_Scaling	5.001		W	T	0%-29% - Pos1; 30%-49% - Pos2; 50%-69% Pos3; 70%-89% - Pos4; 90%-100% - Pos5
		Control_ Vane U-D / 5 pos	1 byte	DPT_Enumerated	5.010		W	T	1 - Pos1; 2 - Pos2; 3 - Pos3; 4 - Pos4; 5 - Pos5
	18	Control_ Vane U-D Pos1	1 bit	DPT_Bool	1.002		W	T	1 - Position 1
	19	Control_ Vane U-D Pos2	1 bit	DPT_Bool	1.002		W	T	1 - Position 2
	20	Control_ Vane U-D Pos3	1 bit	DPT_Bool	1.002		W	T	1 - Position 3
	21	Control_ Vane U-D Pos4	1 bit	DPT_Bool	1.002		W	T	1 - Position 4
	22	Control_ Vane U-D Pos5	1 bit	DPT_Bool	1.002		W	T	1 - Position 5
	23	Control_ Vane U-D Swing	1 bit	DPT_Bool	1.002		W	T	0 - Stop; 1 - Swing
	24	Control_ Vane U-D -/+	1 bit	DPT_Step	1.007		W		0 - Decrease; 1 - Increase
		Control_ Vane U-D +/-	1 bit	DPT_UpDown	1.008		W		0 - Up; 1 - Down
Temperature	25	Control_ Setpoint Temperature	2 bytes	DPT_Value_Temp	9.001		W	T	16°C to 32°C
	26	Control_ Setpoint Temp -/+	1 bit	DPT_Step	1.007		W		0 - Decrease; 1 - Increase
		Control_ Setpoint Temp +/-	1 bit	DPT_UpDown	1.008		W		0 - Up; 1 - Down
	27	Control_ Ambient Temperature	2 bytes	DPT_Value_Temp	9.001		W	T	°C value in EIS5 format
Timeout	28	Control_ Window Contact Status	1 bit	DPT_OpenClose	1.009		W	T	0 - Open; 1 - Closed
		Control_ Switch Off Timeout	1 bit	DPT_Start	1.010		W	T	0 - Stop; 1 - Start

	29	Control_ Occupancy	1 bit	DPT_Occupancy	1.018		W	T	0 - Not Occupied; 1 - Occupied
	30	Control_ Start Sleep Timeout	1 bit	DPT_Start	1.010		W	T	0 - Stop; 1 - Start
Locking	31	Control_ Lock Remote Control	1 bit	DPT_Bool	1.002		W	T	0 - Unlocked; 1 - Locked
	32	Control_ Lock Control Objects	1 bit	DPT_Bool	1.002		W	T	0 - Unlocked; 1 - Locked
Special Modes	33	Control_ Power Mode	1 bit	DPT_Start	1.010		W	T	0 - Stop; 1 - Start
	34	Control_ Econo Mode	1 bit	DPT_Start	1.010		W	T	0 - Stop; 1 - Start
	35	Control_ Additional Heat	1 bit	DPT_Start	1.010		W	T	0 - Stop; 1 - Start
	36	Control_ Additional Cool	1 bit	DPT_Start	1.010		W	T	0 - Stop; 1 - Start
Scenes	37	Control_ Save/Exec Scene	1 byte	DPT_SceneControl	18.001		W	T	0 to 4 - Exec. Scene 1 to 5; 128 to 132 - Save Scene 1 to 5
	38	Control_ Store Scene1	1 bit	DPT_Bool	1.002		W		1 - Store Scene
	39	Control_ Store Scene2	1 bit	DPT_Bool	1.002		W		1 - Store Scene
	40	Control_ Store Scene3	1 bit	DPT_Bool	1.002		W		1 - Store Scene
	41	Control_ Store Scene4	1 bit	DPT_Bool	1.002		W		1 - Store Scene
	42	Control_ Store Scene5	1 bit	DPT_Bool	1.002		W		1 - Store Scene
	43	Control_ Execute Scene1	1 bit	DPT_Bool	1.002		W	T	1 - Execute Scene
	44	Control_ Execute Scene2	1 bit	DPT_Bool	1.002		W	T	1 - Execute Scene
	45	Control_ Execute Scene3	1 bit	DPT_Bool	1.002		W	T	1 - Execute Scene
	46	Control_ Execute Scene4	1 bit	DPT_Bool	1.002		W	T	1 - Execute Scene
	47	Control_ Execute Scene5	1 bit	DPT_Bool	1.002		W	T	1 - Execute Scene
Disabling	48	Control_ Disable Input 1	1 bit	DPT_Bool	1.002		W	T	0 - Enable; 1 - Disable
		Control_ Disable Input 1	1 bit	DPT_Enable	1.003		W	T	0 - Disable; 1 - Enable

	49	Control_Disable Input 2	1 bit	DPT_Bool	1.002		W	T	0 - Enable; 1 - Disable
		Control_Disable Input 2	1 bit	DPT_Enable	1.003		W	T	0 - Disable; 1 - Enable
	50	Control_Disable Input 3	1 bit	DPT_Bool	1.002		W	T	0 - Enable; 1 - Disable
		Control_Disable Input 3	1 bit	DPT_Enable	1.003		W	T	0 - Disable; 1 - Enable
	51	Control_Disable Input 4	1 bit	DPT_Bool	1.002		W	T	0 - Enable; 1 - Disable
		Control_Disable Input 4	1 bit	DPT_Enable	1.003		W	T	0 - Disable; 1 - Enable
On/Off	53	Status_On/Off	1 bit	DPT_Switch	1.001	R		T	0 - Off; 1-On
Mode	54	Status_Mode	1 byte	DPT_HVACContrMode	20.105	R		T	0 - Auto; 1 - Heat; 3 - Cool; 9 - Fan; 14 - Dry
	55	Status_Mode Cool/Heat	1 bit	DPT_Heat/Cool	1.100	R		T	0 - Cool; 1 - Heat
	56	Status_Mode Auto	1 bit	DPT_Bool	1.002	R		T	1 - Auto
	57	Status_Mode Heat	1 bit	DPT_Bool	1.002	R		T	1 - Heat
	58	Status_Mode Cool	1 bit	DPT_Bool	1.002	R		T	1 - Cool
	59	Status_Mode Fan	1 bit	DPT_Bool	1.002	R		T	1 - Fan
	60	Status_Mode Dry	1 bit	DPT_Bool	1.002	R		T	1 - Dry
	61	Status_Mode Text	14 bytes	DPT_String_8859_1	16.001	R		T	ASCII String
Fan Speed	62	Status_Fan Speed / 2 Speeds	1 byte	DPT_Scaling	5.001	R		T	50% - Speed 1; 100% - Speed 2
		Status_Fan Speed / 3 Speeds	1 byte	DPT_Scaling	5.001	R		T	33% - Speed 1; 67% - Speed 2; 100% - Speed 3
		Status_Fan Speed / 2 Speeds	1 byte	DPT_Scaling	5.001	R		T	1 - Speed 1; 2 - Speed 2
		Status_Fan Speed / 3 Speeds	1 byte	DPT_Scaling	5.001	R		T	1 - Speed 1; 2 - Speed 2; 3 - Speed 3
	63	Status_Fan Speed AUTO	1 bit	DPT_Bool	1.002	R		T	1 - Fan AUTO enable; 0 - Fan AUTO disabled
	64	Status_Fan Speed 1	1 bit	DPT_Bool	1.002	R		T	1 - Speed 1
	65	Status_Fan Speed 2	1 bit	DPT_Bool	1.002	R		T	1 - Speed 2

	66	Status_ Fan Speed 3	1 bit	DPT_Bool	1.002	R		T	1 - Speed 3
	67	Status_ Fan Speed Text	14 bytes	DPT_String_8859_1	16.001	R		T	ASCII String
Vanes	68	Status_ Vane U-D / 5 pos	1 byte	DPT_Scaling	5.001	R		T	20% - Pos1; 40% - Pos2; 60% - Pos3; 80% - Pos4; 100% - Pos5
		Status_ Vane U-D / 5 pos	1 byte	DPT_Enumerated	5.010	R		T	1 - Pos1; 2 - Pos2; 3 - Pos3; 4 - Pos4; 5 - Pos5
	69	Status_ Vane U-D Pos1	1 bit	DPT_Bool	1.002	R		T	1 - Position 1
	70	Status_ Vane U-D Pos2	1 bit	DPT_Bool	1.002	R		T	1 - Position 2
	71	Status_ Vane U-D Pos3	1 bit	DPT_Bool	1.002	R		T	1 - Position 3
	72	Status_ Vane U-D Pos4	1 bit	DPT_Bool	1.002	R		T	1 - Position 4
	73	Status_ Vane U-D Pos5	1 bit	DPT_Bool	1.002	R		T	1 - Position 5
	74	Status_ Vane U-D Swing	1 bit	DPT_Bool	1.002	R		T	0 - Stop; 1 - Swing
	75	Status_ Vane U-D Text	14 bytes	DPT_String_8859_1	16.001	R		T	ASCII String
Temperature	76	Status_ AC Setpoint Temp	2 bytes	DPT_Value_Temp	9.001	R		T	16°C to 32°C
	77	Status_ AC Return Temp	2 bytes	DPT_Value_Temp	9.001	R		T	°C value in EIS5 format
Error	78	Status_ Error/Alarm	1 bit	DTP_Alarm	1.005	R		T	0 - No Alarm; 1 - Alarm
	79	Status_ Error Code	2 bytes	Enumerated		R		T	0 - No Error; Any other see user's manual
	80	Status_ Error Text	14 bytes	Character string (ISO 8859-1)	16.001	R		T	2 char Daikin Error; Empty no error
Locking	81	Status_Lock Remote Control	1 bit	DPT_Bool	1.002		W	T	0 - Unlocked; 1 - Locked
	82	Status_Lock Control Objects	1 bit	DPT_Bool	1.002		W	T	0 - Unlocked; 1 - Locked
Special Modes	83	Status_ Power Mode	1 bit	DPT_Switch	1.001	R		T	0 - Off; 1-On
	84	Status_ Econo Mode	1 bit	DPT_Switch	1.001	R		T	0 - Off; 1-On
	85	Status_ Additional Heat	1 bit	DPT_Switch	1.001	R		T	0 - Off; 1-On

	86	Status_ Additional Cool	1 bit	DPT_Switch	1.001	R		T	0 - Off; 1-On	
Counter	87	Status_ Operation Hour Counter	2 bytes	DPT_Value_2_Ucount	7.001	R		T	Number of operating hours	
	88	Status_ Operation Second Counter	4 bytes	DPT_Value_counter pulses (signed)	13.001	R		T	Number of operating seconds	
Scene	89	Status_ Current Scene	1 byte	DPT_Scene Number	17.001	R		T	0 to 4 - Scene 1 to 5; 63 - No Scene	
Legacy	90	Legacy_ Mode	1 byte	Enumerated		R		T	0 - Auto; 1 - Heat; 2 - Dry; 3 - Fan; 4 - Cool	
	91	Legacy_ Fan Speed	1 byte	Enumerated		R		T	0 - Speed 1; 1 - Speed 2; 2 - Speed 3	
	92	Legacy_ Vanes Up-Down	1 byte	Enumerated		R		T	0 to 4 - Pos 1 to Pos 5; 5 - Swing	
Binary Inputs	93	Status_ In1 - Switching	1 bit	DPT_Switch	1.001	R		T	0 - Off; 1-On	
		Status_ In1 - Dimming - On/Off	1 bit	DPT_Switch	1.001	R		T	0 - Off; 1-On	
Binary inputs	93	Status_ In1 - Shut/Blind - Step	1 bit	DPT_ShutterBlinds	1.023	R		T	0 - step up; 1 - step down	
		Status_ In1 - Dimming - Step (%)	4 bits	DPT_Dimming control	3.007	R		T	0 - increasing step; 1 - decreasing step	
		Status_ In1 - Shut/Blind - Move	1 bit	DPT_up/down	1.008	R		T	0 - move up; 1 - move down	
	94	Status_ In1 - Value	1 byte	DPT_Value_1_Ucount	5.010	R		T	1 - byte unsigned value	
		95	Status_ In2 - Switching	1 bit	DPT_Switch	1.001	R		T	0 - Off; 1-On
			Status_ In2 - Dimming - On/Off	1 bit	DPT_Switch	1.001	R		T	0 - Off; 1-On
			Status_ In2 - Shut/Blind - Step	1 bit	DPT_ShutterBlinds	1.023	R		T	0 - step up; 1 - step down
		96	Status_ In2 - Dimming - Step (%)	4 bits	DPT_Dimming control	3.007	R		T	0 - increasing step; 1 - decreasing step
			Status_ In2 - Shut/Blind - Move	1 bit	DPT_up/down	1.008	R		T	0 - move up; 1 - move down
	Status_ In2 - Value		1 byte	DPT_Value_1_Ucount	5.010	R		T	1 - byte unsigned value	
	97	Status_ In3 - Switching	1 bit	DPT_Switch	1.001	R		T	0 - Off; 1-On	
Status_ In3 - Dimming - On/Off		1 bit	DPT_Switch	1.001	R		T	0 - Off; 1-On		

		Status_ In3 - Shut/Blind - Step	1 bit	DPT_ShutterBlinds	1.023	R		T	0 - step up; 1 - step down	
	98	Status_ In3 - Dimming - Step (%)	4 bits	DPT_Dimming control	3.007	R		T	0 - increasing step; 1 - decreasing step	
		Status_ In3 - Shut/Blind - Move	1 bit	DPT_up/down	1.008	R		T	0 - move up; 1 - move down	
		Status_ In3 - Value	1 byte	DPT_Value_1_Ucount	5.010	R		T	1 - byte unsigned value	
	99	Status_ In4 - Switching	1 bit	DPT_Switch	1.001	R		T	0 - Off; 1-On	
		Status_ In4 - Dimming - On/Off	1 bit	DPT_Switch	1.001	R		T	0 - Off; 1-On	
		Status_ In4 - Shut/Blind - Step	1 bit	DPT_ShutterBlinds	1.023	R		T	0 - step up; 1 - step down	
	100	Status_ In4 - Dimming - Step (%)	4 bits	DPT_Dimming control	3.007	R		T	0 - increasing step; 1 - decreasing step	
	Binary inputs	100	Status_ In4 - Shut/Blind - Move	1 bit	DPT_up/down	1.008	R		T	0 - move up; 1 - move down
			Status_ In4 - Value	1 byte	DPT_Value_1_Ucount	5.010	R		T	1 - byte unsigned value