

K-BUS[®] WALTZ series

KNX Push Button Sensor, 2/3/4-gang_V1.7

CHPB-04/02.1.2x

CHPB-06/02.1.2x

CHPB-08/02.1.2x

(x=0: White; x=1: Black; x=2: Silver; x=3: Gray; x=4: Golden)



KNX/EIB Home and Building Control System

Attentions

1. Please keep devices away from strong magnetic field, high temperature, wet environment;

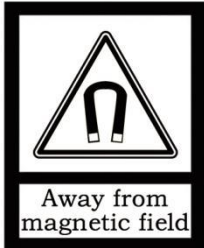

2. Do not fall the device to the ground or make them get hard impact;



3. Do not use wet cloth or volatile reagent to wipe the device;



4. Do not disassemble the devices.

Contents

Chapter 1 Summary	1
Chapter 2 Technical Data	2
Chapter 3 Dimension and Structural Diagram	3
3.2. Dimension Diagram	3
3.3. Structural Diagram	4
Chapter 4 Project Design and Programming	5
Chapter 5 Parameter setting description in the ETS	7
5.2. Parameter window "General"	7
5.2.1. Parameter window "General setting"	7
5.2.2. Parameter window "Proximity setting"	11
5.2.3. Parameter window "Advanced setting"	12
5.3. Parameter window "Internal temperature measurement"	13
5.4. Parameter window "Input"	16
5.4.1. Temperature probe	17
5.4.2. Binary input	20
5.5. Parameter window "Button"	25
5.5.1. Switch function	26
5.5.2. Dimming function	28
5.5.3. RGB lighting	30
5.5.4. RGBW lighting	31
5.5.5. Colour temperature control	32
5.5.6. Value sender function	33
5.5.7. Scene function	34
5.5.8. Blind function	35
5.5.9. Shift register function	36
5.5.10. Multiple operation function	39
5.5.11. Delay mode function	40
5.5.12. RTC mode function	41
5.5.13. String function	43
5.5.14. LED indication function	44
5.5.15. Parameter window "Customized colour"	48
5.6. Parameter window "Logic"	49
5.6.1. Parameter window "AND/OR/XOR"	50
5.6.2. Parameter window "Gate forwarding"	52
5.6.3. Parameter window "Threshold comparator"	53
5.6.4. Parameter window "Format convert"	56
5.6.5. Parameter window "Gate function"	57
5.6.6. Parameter window "Delay function"	58

5.6.7. Parameter window "Staircase lighting" -----	59
5.7. Parameter window "Scene Group" -----	60
Chapter 6 Description of Communication Object -----	63
6.2. "General" Communication Object -----	63
6.3. "Internal sensor" Communication Object -----	64
6.4. "Input" Communication Object -----	64
6.5. "Button" Communication Object -----	67
6.6. "Logic" Communication Object -----	76
6.6.1. "AND/OR/XOR" Communication Object -----	76
6.6.2. "Gate forwarding" Communication Object -----	76
6.6.3. "Threshold comparator" Communication Object -----	77
6.6.4. "Format convert" Communication Object -----	78
6.6.5. "Gate function" Communication Object -----	80
6.6.6. "Delay function" Communication Object -----	81
6.6.7. "Staircase lighting" Communication Object -----	82
6.7. "Scene Group" Communication Object -----	83

Chapter 1 Summary

KNX Push Button Sensor, 4/6/8 buttons integrates the basic control functions of Switch, Dimming, RGB/RGBW lighting, Colour temperature control, Blind, Scene, Value sender, Shift register, Multiple operation, Delay mode, RTC operation mode, String sending, and has a built-in temperature sensor to detect the local ambient temperature and supports RGB indication function.

In addition, the series products support Logic function and Scene Group function, and 2 external input interfaces (as Binary input detection or NTC detection), provide more possibilities for special and complex applications.

KNX Push Button Sensor, 4/6/8 buttons powered from KNX bus. It is available to assign the physical address and configure the parameters by engineering design tools ETS with .knxprod (support edition ETS5.7 or higher).

The functions are summarized as followed:

- Switch and Dimming
- Blind control
- Value sender
- Scene control
- Shift register
- RGB , RGBW and colour temperature control
- Multiple operation
- Delay mode
- Send RTC operation mode
- Send Strings
- Built-in temperature sensor
- Logic output, Scene group conversion;
- RGB LED indication function

Chapter 2 Technical Data

Power Supply	Bus voltage	21-30V DC, via the KNX bus
	Bus current	<21mA, 24V <18.5mA, 30V
	Bus consumption	<555mW
Input	2 external inputs, as dry contact input or 10K NTC input	
Connection	KNX	Bus connection terminal(Red/Black)
	Input	Screw terminals, Wire Range: Multi-core 0.2-1.5mm ² Single core 0.2-2.5mm ² Torque 0.4N-m Length <5m
Temperature	Operation	- 5 °C ... 45 °C
	Storage	- 25 °C ... 55 °C
	Transport	- 25 °C ... 70 °C
Environment	Humidity	<93%, except dewing
Dimension	86 × 86 × 33mm	
Weight	0.09kg	

Chapter 3 Dimension and Structural Diagram

3.2. Dimension Diagram

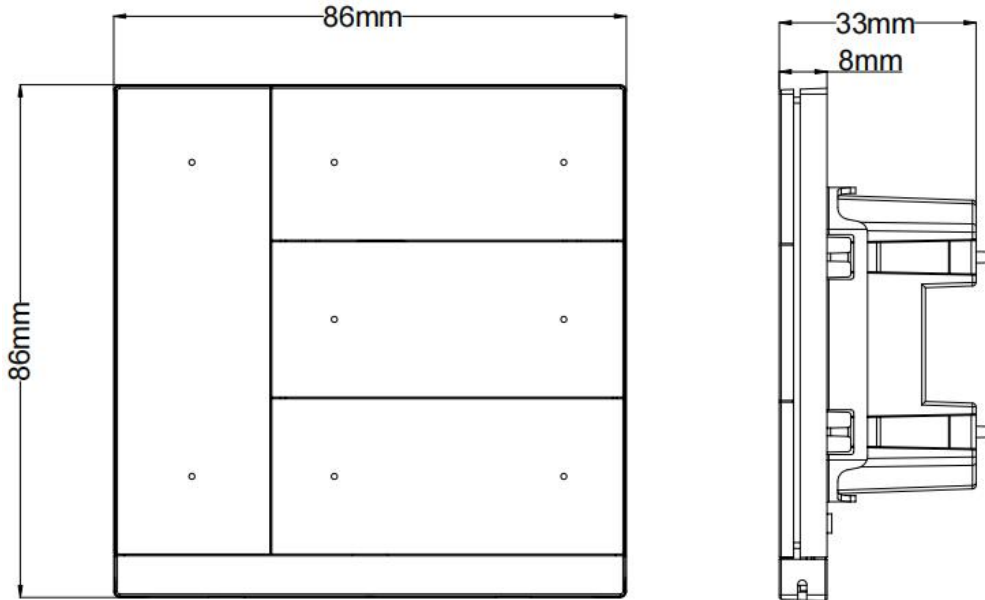

Panel dimension

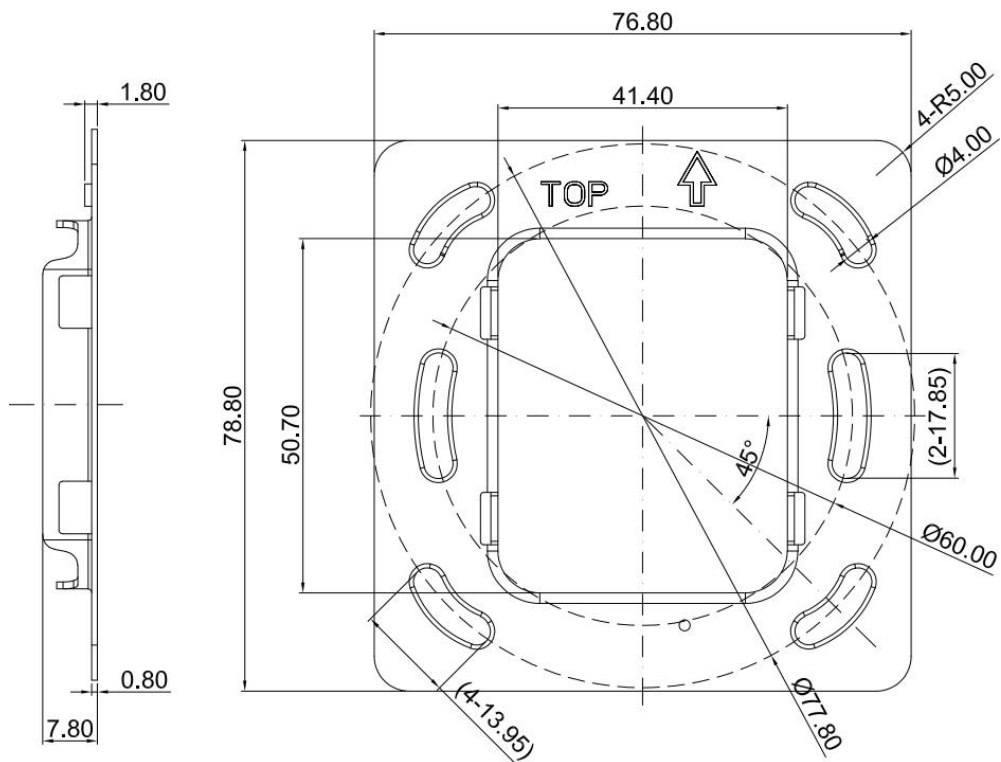

Metal plate dimension

3.3. Structural Diagram

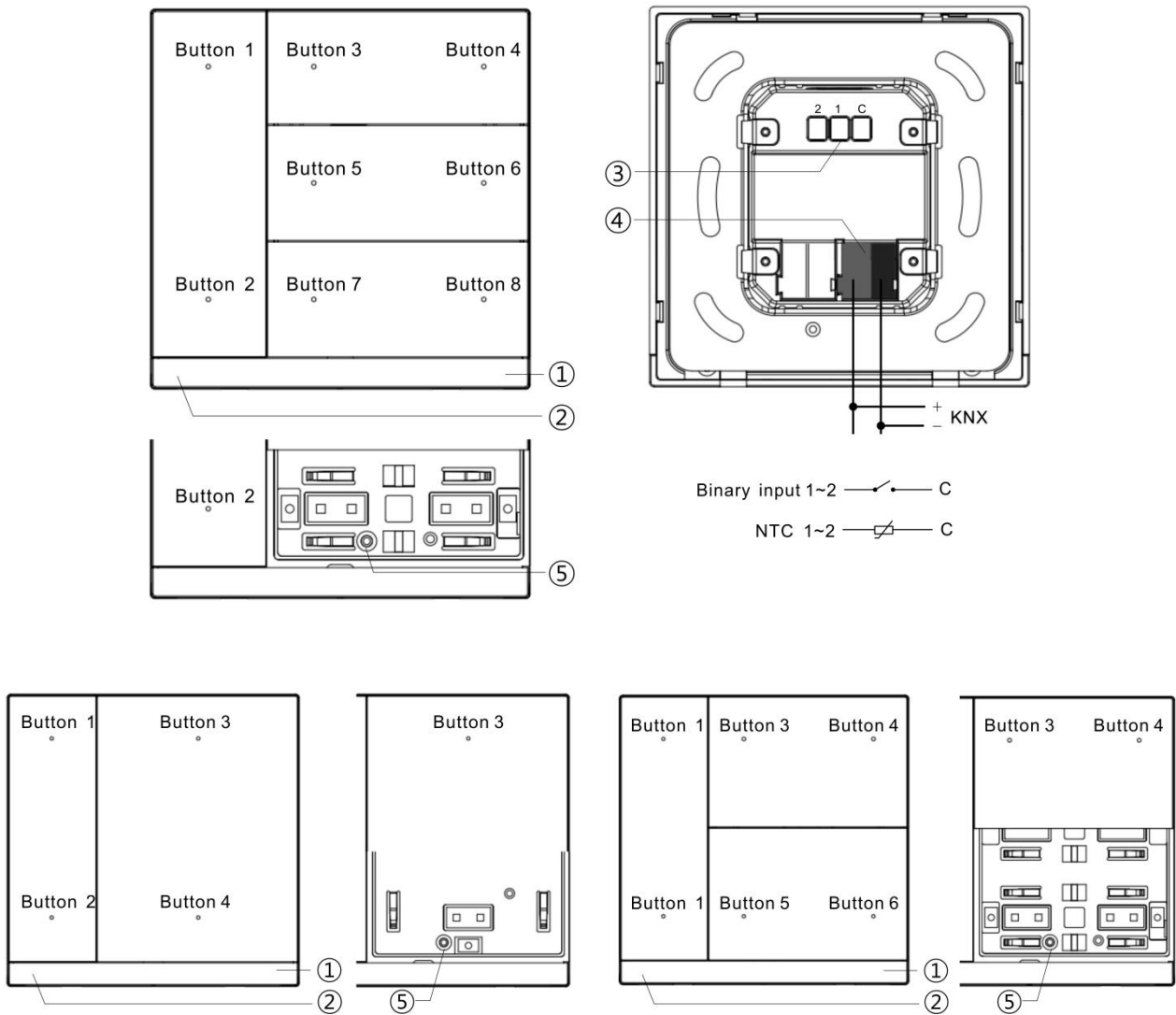

① Internal temperature sensor

② Programming button and LED

③ Input terminals

④ KNX bus connection terminal

⑤ Fit bolt for anti-theft protection

(included with the rocker cover)

Chapter 4 Project Design and Programming

Application	Maximum of communication objects	Maximum number of group addresses	Maximum number of associations
KNX Push Button Sensor, 2-gang/1.0	207	500	500
KNX Push Button Sensor, 3-gang/1.0			
KNX Push Button Sensor, 4-gang/1.0			

General function

General function includes device In operation setting, KNX telegrams delay time setting, request device status after voltage recovery. And support whether to enable normal/night mode.

Temperature measurement function

Support internal temperature measurement, and can be sent to the bus after change or cyclically;

Support high or low temperature alarm, and can be sent to the bus.

External input interface function

Up to support 2 channels, enable/disable each channel functions. Optional dry contact detection or NTC temperature detection.

When selecting dry contact detection, only supports the basic functions, including switch, scene send strings (press/release, short/long, send after voltage recovery, disable function).

When selecting NTC temperature detection, the external temperature probe can be connected to detect the external temperature and the B value data of temperature sensing probe needs to be set.

Button function

Each button can be configured as independent function, and can activate disable function. Support the functions, including switch, dimming, blind, scene, value sender, shift register, multiple operation, delay mode, RTC operation mode, send strings.

For switch and scene functions, it is possible to configure whether long and short operation to select common 1 object or separate 2 objects.

Indication LED function

Brightness level of indication LED is adjustable, and adjusted according to normal/night status. And set the delay time for entering standby mode and for LED status all turned off.

When the delay time is not 0, enable/disable panel orientation indication function, support to set the work mode, colour, indication period time and brightness.

The indication settings for button functions:

①Disable, Control by button switch object, Control by external object (1bit/1byte), Indicate button press (Flash and Always on), Always on.

②The LED indication colours can be set independently. When customized colours are used, Customized colour configuration is required.

Logic function

Up to support 8 channels of logic, each channel up to support 8 inputs and 1 logic result.

Logic function support functions, including AND, OR, XOR, Gate forwarding, Threshold comparator, Format convert, Gate function, Delay function and Staircase lighting.

Scene group function

Up to support 8 channels of scene group forward, each group up to support 8 configurable output, datatype is optional 1bit/1byte/2byte.

Chapter 5 Parameter setting description in the ETS

5.2. Parameter window “General”

5.2.1. Parameter window “General setting”

--- KNX Push Button Sensor, 4-gang > General > General setting

General

General setting

Proximity setting

Advanced setting

Internal temperature meas...

Button

Send delay after voltage recovery [0..15] s

Send cycle of "In operation" telegram [1..240,0=inactive] s

Extension function

Night mode

Night mode need send read request after voltage recovery

i Note: Default to normal mode if no response when request after startup

Proximity function via bus

Brightness setting

Status LED brightness in normal mode %

Status LED brightness in night mode %

Status LED brightness in standby mode %

Delay time after no operation for standby mode [0...255,0=inactive] s

Delay time for turn off all status LED after standby mode [0...255,0=inactive] s

Wake up device via any button operation

Panel orientation indication when turn off status LED

LED 8 reuse as indication LED

Work mode

Colour of indication LED

Indication period time s

Brightness of indication LED %

Fig.5.1.1 “General setting” parameter window

Parameter “Send delay after voltage recovery [0..15]s”

This parameter is for setting the delay time that sends status request telegram to bus after the device voltage recovery. Options: **0..15**

The setting dose not contain the device initialization time, and bus telegrams received during delay time will be recorded.

Parameter "Send cycle of "In operation" telegram [1..240,0=inactive]s"

This parameter is for setting the time interval when this device cycle send telegrams through the bus to indicate this device in normal operation. When set to "0", the object "In operation" will not send a telegram. If the setting is not "0", the object "In operation" will send a telegram according to the set period time with logic "1" to the bus. Options: **0...240s, 0= inactive**

As to reduce the bus load as much as possible, the maximum time interval should be selected according to actual needs.

Extension function

Parameter "Night mode"

Parameters as follow are visible when the parameter enabled, to set night mode.

Parameter "Night mode need send read request after voltage recovery"

This parameter is for setting whether the object "Night mode" to send read request when bus recovery or finish programming.

If send the read request, LED indicates according to setting brightness of responded normal/night mode.

Note: Default to normal mode if no response when request after startup

This note is visible when previous parameter is enabled.

Parameter "Proximity function via bus"

This parameter is for setting whether to link the panel by receiving proximity signal from the bus, and display the interface "Proximity setting" after enabled.

Brightness setting

Parameter "Status LED brightness in normal mode"

This parameter is for setting the button LED brightness when indicated during normal or day mode.

Options:

0%

5%

10%

20%

...

70%

Parameter "Status LED brightness in night mode"

This parameter is visible when night mode enabled. Set the button LED brightness when indicated during night mode. Options:

0%

5%

10%

20%

...

70%

Parameter "Status LED brightness in standby mode"

This parameter is visible when the delay time for the normal mode to enter the standby mode is not 0. Set the button LED brightness when indicated during standby mode. Options:

5%

10%

20%

...

70%

Parameter "Delay time after no operation for standby mode [0...255,0=inactive]s"

This parameter is for setting the delay time for the normal mode to enter the standby mode. When 0, it will not activate standby mode. Options: **0...255,0=inactive**

Parameter "Delay time for turn off all status LED after standby mode[0...255,0=inactive]s"

This parameter is visible when the delay time for the normal mode to enter the standby mode is not 0. Set the delay time for turn off all indication LED after standby mode. When 0, the command to turn off all LED will not be executed. Options: **0...255,0=inactive**

Parameter "Delay time for turn off all status LED[0...255,0=inactive]s"

This parameter is visible when the delay time for the normal mode to enter the standby mode is 0. Set the delay time for turn off all indication LED after normal mode. When 0, the command to turn off all

LED will not be executed. Options: **0...255,0=inactive**

Parameter "Wake up device via any button operation"

This parameter is visible when the delay time for the indication LED all to go off is not 0. Set whether to wake up the panel via any button operation. If a wake-up is required, the first operation when the LEDs are all off is not a functional response; if it is not required, then each button operation is responsive.

Parameter "Panel orientation indication when turn off status LED"

This parameter is visible when the delay time for the indication LED all to go off is not 0. Set whether to activate panel orientation indication when turn off all LED. Options:

Disable

Always trigger

Trigger via object

Parameters as follow are visible when panel orientation indication function is enabled:

LED x reuse as indication LED(x=2/4/6/8, display according to push button type)

Parameter "Work mode"

This parameter is visible when panel orientation indication function is enabled and selected "Trigger via object". Set the work mode for panel orientation indication. Options:

0=trigger/1=no trigger

1=trigger/0=no trigger

0 is trigger,1 is no reaction

1 is trigger,0 is no reaction

Parameter "Colour of indication LED"

This parameter is for setting the colour of panel orientation indication LED. Options:

Red

Orange

Green

Cyan blue

Blue

Customized colour 1

White

Customized colour 2

Yellow

Customized colour 3

Cyan

Customized colour 4

Magenta

Customized colour 5

Parameter "Indication period time"

Orientation indication LED lights up is a fading soft flashing effect, with a fixed time of approx. 5s from dark to light and back again. This parameter defines a full cycle, that is including two periods, 5s for the soft flashing effect and always off. The longer the set time is, the longer the time of always off is longer. Options:

10s

20s

...

60s

Parameter "Brightness of indication LED"

This parameter is for setting the brightness of panel orientation indication LED. Options:

5%

10%

20%

...

50%

5.2.2. Parameter window "Proximity setting"

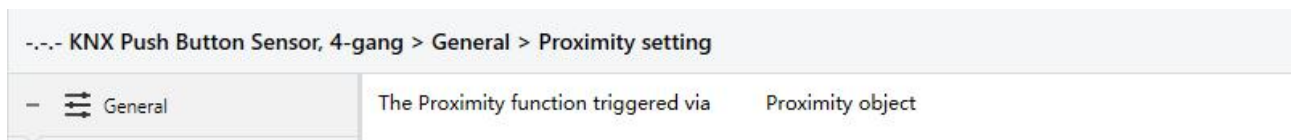

Fig.5.1.2 "Proximity setting" parameter window

Parameter "The Proximity function triggered via"

This parameter is for setting the trigger way of proximity function.

Option is read-only by default **Proximity object**

Proximity object: When another device on the bus supports proximity function and can send a sense signal, the proximity signal can be received via the object "Proximity input".

5.2.3. Parameter window "Advanced setting"

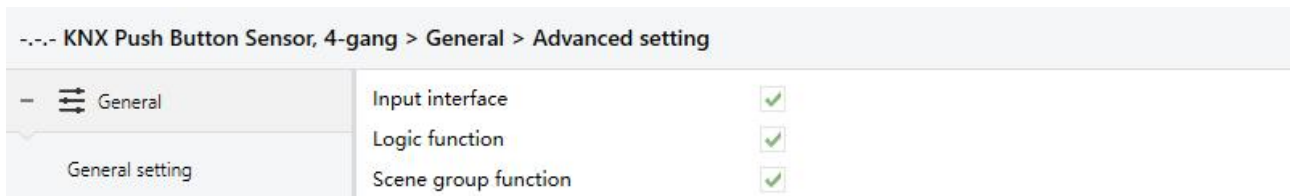

Fig.5.1.3 "Advanced setting" parameter window

Parameter "Input interface"

Setting page of input interface is visible after this parameter enabled.

Parameter "Logic function"

Setting page of logic function is visible after this parameter enabled.

Parameter "Scene group function"

Setting page of scene group function is visible after this parameter enabled.

5.3. Parameter window “Internal temperature measurement”

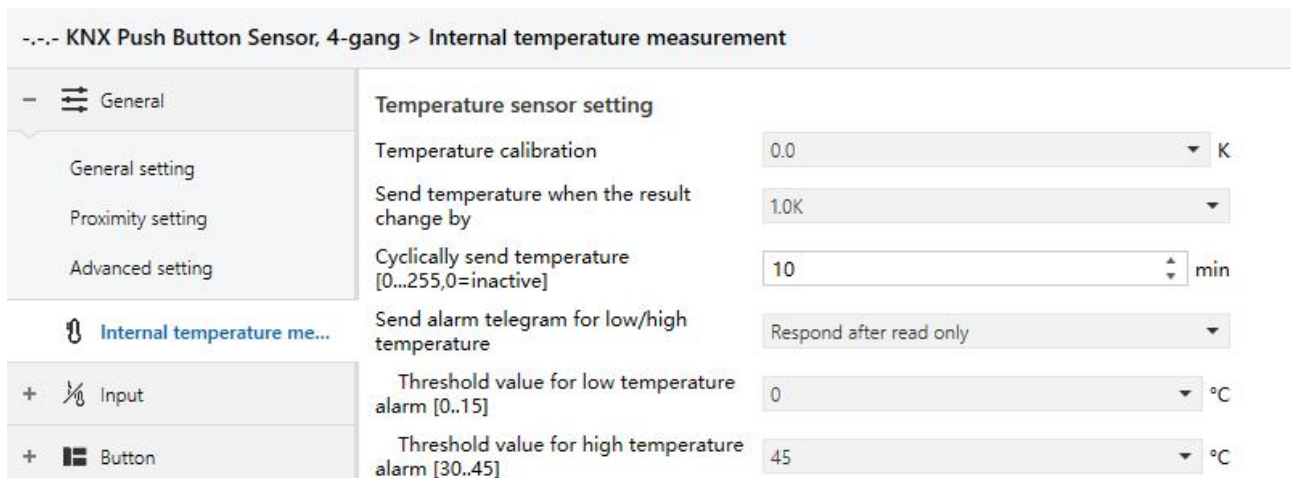

Fig.5.2 “Internal temperature measurement” parameter window

The following parameters is used for setting the calibration value, sending condition and error report of internal sensor. If internal sensor is selected for other functions as well, please refer to this section.

Temperature sensor setting

Parameter “Temperature calibration”

This parameter is for setting the temperature calibration value of the internal sensor, that is, to calibrate the measured value of internal sensor to make it closer to the current ambient temperature.

Options:

-5.0K

...

0.0K

...

5.0K

Note: after the device is powered on, the stability time of internal sensor detection will take 30 minutes, therefore, the detected temperature value in the early stage of device work may be inaccurate.

Parameter “Send temperature when the result change by”

This parameter is for setting when temperature turns to a certain value, whether to enable to send the current temperature value to the bus. Not send when disable. Options:

Disable

0.5K

1.0K

...

10K

Parameter "Cyclically send temperature [0...255,0=inactive]min"

Setting the time for cyclically sending the temperature detection value to the bus. Options: **0..255**

This period is independent and starts time counting after programming completion or reset.

Transmission change has no affect on this period.

Parameter "Send alarm telegram for low/high temperature"

This parameter is for setting condition of sending telegram when low/high temperature alarm.

Options:

No respond

Respond after read only

Respond after change

Respond after read only: Only when the device receives a read alarm from other bus device or bus will the object "Low temperature alarm"/" High temperature alarm" send the alarm status to the bus;

Respond after change: the object " Low temperature alarm"/" High temperature alarm" will immediately send the telegram to the bus to report the alarm value when the alarm status has changed.

These two parameters as follow are visible when "Respond after read only" or "Respond after change" are selected.

—Parameter "Threshold value for low temperature alarm [0..15]°C"

This parameter is for setting the threshold value for low temperature alarm. When the temperature lower than low threshold, low temperature alarm object will send telegram. Options:

0°C

1°C

...

15°C

—Parameter “Threshold value for high temperature alarm [30..45]°C”

This parameter is for setting the threshold value for high temperature alarm. When the temperature higher than high threshold, high temperature alarm object will send telegram. Options:

30°C

31°C

...

45°C

5.4. Parameter window "Input"

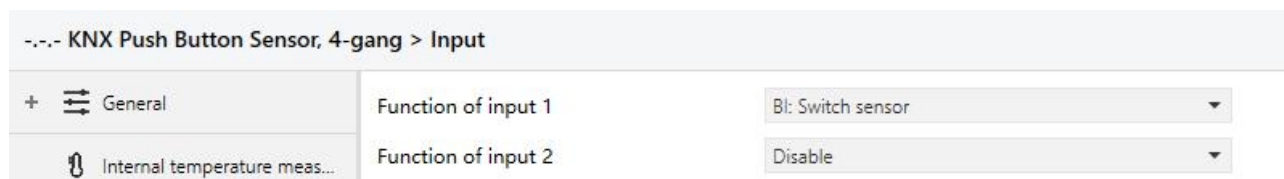

Fig.5.3 "Input" parameter window

Parameter "Function of input x" (x=1, 2)

This parameter is for setting the function of external input interface. Support temperature detection and dry contact input (BI), setting page will be visible when select corresponding chosen.

Also can be disable this channel function. Options:

Disable

Temperature probe(NTC 10K)

BI: Switch sensor

BI: Scene control

BI: Send String(14bytes)

When select Temperature probe(NTC 10K), can detect external temperature, which needs set B value of temperature probe.

When select dry contact input (BI), only supports the basic functions, including switch, scene send strings (press/release, short/long, send after voltage recovery, disable function).

Chapters as follow explain the functions of external input interface separately.

5.4.1. Temperature probe

--- KNX Push Button Sensor, 4-gang > Input > Input 1 - Temperature probe

+ General	Description (max 30char.)	<input type="text"/>
Internal temperature meas...	B value of temperature sensor (must refer to the characteristic of component)	3950 ▼
- Input	Temperature calibration	0.0 ▼ K
Input 1 - Temperature probe	Send temperature when the result change by	1.0K ▼
+ Button	Cyclically send temperature [0...255]	0 min
+ Logic	Reply error of sensor measurement	Respond after read only ▼
+ Scene Group	Object value of error	<input checked="" type="radio"/> 0=no error/1=error <input type="radio"/> 1=no error/0=error
	Lower threshold value for error report	0 °C ▼
	Upper threshold value for error report	60 °C ▼

Fig.5.3.1 Parameter setting of temperature probe

Parameter "Description (max 30char.)"

This parameter is for setting the name description of temperature probe.

Parameter "B value of temperature sensor(must refer to the characteristic of component)"

This parameter is for setting the B value of temperature sensor. Options:

3275

3380

...

4200

Note: This value must refer to the characteristic of component, available from the instruction manual. If selected B value is different from used sensor, it will effect detection result directly.

Parameter "Temperature calibration"

This parameter is for setting the temperature calibration value of the temperature sensor, that is, to calibrate the measured value of sensor to make it closer to the current ambient temperature. Options:

-5.0K

...

0.0K

...

5.0K

Parameter "Send temperature when the result change by"

This parameter is for setting when temperature turns to a certain value, whether to enable to send the current temperature value to the bus. Not send when disable. Options:

Disable

0.5K

1.0K

...

10K

Parameter "Cyclically send temperature [0..255,0=inactive]min"

Setting the time for cyclically sending the temperature detection value to the bus. Not send when value is 0.

Options: **0..255**

Parameter "Reply error of sensor measurement"

This parameter for setting the condition of sending error status report when temperature exceeds the valid detection. Options:

No respond

Respond after read only

Respond after change

Respond after read only: Only when the device receives a read error from other bus device or bus will the object "Temperature error report, Sensor" send the error status to the bus;

Respond after change: The object "Temperature error report, Sensor" will immediately send the telegram to the bus to report the error value when the error status has changed.

These three parameters as follow are visible when "Respond after read only" or "Respond after change" are selected.

—Parameter "Object value of error"

This parameter for defining object value of error. Options:

0=no error/1=error

1=no error/0=error

0=no error/1=error: The object value for which sensor no error occurs is 0, and the object value for which sensor error occurs is 1;

1=no error/0=error: It has the opposite meaning.

—Parameter “Upper threshold value for error report”

This parameter is for setting the upper threshold value for temperature error. When the temperature higher than the threshold, temperature error object will send telegram.

Options: **40°C / 45°C / 50°C / 55°C / 60°C / 70°C**

—Parameter “Lower threshold value for error report”

This parameter is for setting the lower threshold value for temperature error. When the temperature lower than the threshold, temperature error object will send telegram.

Options: **10°C / 5°C / 0°C / -5°C / -10°C / -20°C**

5.4.2. Binary input

--- KNX Push Button Sensor, 4-gang > Input > Input 1 - Switch sensor

+ General	Description (max 30char.)	<input type="text"/>
Internal temperature meas...	Distinction between short and long operation	<input checked="" type="radio"/> No <input type="radio"/> Yes
- Input	Reaction on close the contact	ON
	Reaction on open the contact	OFF
	Send object value after voltage recovery (valid if reaction is not toggle)	<input checked="" type="radio"/> No <input type="radio"/> Yes
	Number of objects	<input checked="" type="radio"/> 1 <input type="radio"/> 2
	Disable function	Disable

Fig.5.3.2(1) Parameter setting of switch sensor

--- KNX Push Button Sensor, 4-gang > Input > Input 1 - Scene control

+ General	Description (max 30char.)	<input type="text"/>
Internal temperature meas...	Distinction between short and long operation	<input type="radio"/> No <input checked="" type="radio"/> Yes
- Input	Long operation after [3..25]	5 *0.1s
	Connected contact type	<input checked="" type="radio"/> Normally open <input type="radio"/> Normally closed
	Reaction on short operation	Recall scene
	8 bit scene number	Scene No.1
	Reaction on long operation	Store scene
	8 bit scene number	Scene No.1
	Number of objects	<input checked="" type="radio"/> 1 <input type="radio"/> 2
	Disable function	Disable

Fig.5.3.2(2) Parameter setting of scene control

--- KNX Push Button Sensor, 4-gang > Input > Input 1 - Send String

+ General	Description (max 30char.)	<input type="text"/>
Internal temperature meas...	Distinction between short and long operation	<input checked="" type="radio"/> No <input type="radio"/> Yes
- Input	Reaction on close the contact	<input type="radio"/> No reaction <input checked="" type="radio"/> Send Value
	String (14byte) value	Hello, world !
	Reaction on open the contact	<input checked="" type="radio"/> No reaction <input type="radio"/> Send Value
	Send object value after voltage recovery	<input checked="" type="radio"/> No <input type="radio"/> Yes
	Disable function	Disable

Fig.5.3.2(3) Parameter setting of sending string

Parameter "Description (max 30char.)"

This parameter is for setting the name description for binary input function.

Parameter "Distinction between short and long operation"

This parameter is for setting whether to distinction between short and long operation. Options:

No

Yes

—Parameter "Long operation after [3..25]*0.1s"

This parameter is visible when distinction between short and long operation. Set the effective time of long operation. When button operation out of the setting time, it is a long operation, otherwise it is a short operation.

Options: **3..25**

—Parameter "Connected contact type"

This parameter is visible when distinction between short and long operation. Set the connected contact type.

Options:

Normally open

Normally closed

When function is selected "BI: Switch sensor", the following parameters are visible, for setting switch sensor.

—Parameter "Reaction on short/long operation"

This parameter is visible when distinction between short and long operation, performing the action according to the settings of the short and long operations. Set the switch value to send when button operation. Options:

No reaction

OFF

ON

TOGGLE

No reaction: No telegrams have been sent.

ON: Send the on telegram.

OFF: Send the off telegram.

TOGGLE: Each operation will alternate between on and off.

—Parameter “Reaction on close/open the contact”

This parameter is visible when no distinction between short and long operation. Detect the close and open operations, and perform the actions according to the settings. Set the switch value to send when button operation. Options:

No reaction

OFF

ON

TOGGLE

—Parameter “Send object value after voltage recovery (valid if reaction is not toggle)”

This parameter is visible when no distinction between short and long operation. This parameter is valid if not select “TOGGLE” or “No reaction”, set whether to send object value after voltage recovery.

Options:

No

Yes

When function is selected “BI: Scene control”, the following parameters are visible, for setting scene control.

—Parameter “Reaction on short/long operation”

This parameter is visible when distinction between short and long operation, performing the action according to the settings of the short and long operations. Set the scene command to send when button operation. Options:

No reaction

Recall scene

Store scene

—Parameter “Reaction on close/open the contact”

This parameter is visible when no distinction between short and long operation. Detect the close and open operations, and send or storage scenes according to the settings. Set the scene command to send when button operation. Options:

No reaction

Recall scene

Store scene

—Parameter “8 bit scene number”

This parameter is visible when “Recall scene” or “Store scene” is selected. Set the scene number, range: **Scene NO.1~64, corresponding telegram is 0~63**

When function is selected “BI: Send String(14bytes)”, the following parameters are visible, for setting string sending.

—Parameter “Reaction on short/long operation”

This parameter is visible when distinction between short and long operation, performing the action according to the settings of the short and long operations. Options:

No reaction

Send Value

—Parameter “Reaction on close/open the contact”

This parameter is visible when no distinction between short and long operation. Detect the close and open operations, and send strings according to the settings. Options:

No reaction

Send Value

—Parameter “String (14byte) value”

This parameter is visible when “Send Value” is selected. Input the strings to send.

—Parameter “Send object value after voltage recovery”

This parameter is visible when no distinction between short and long operation. Set whether to send object value after voltage recovery. Options:

No

Yes

Parameter “Number of objects”

This parameter is visible when the parameter “Reaction on long/open operation” is not selected “No reaction”. Set whether to use a common object or two separate objects when open/close and long/short operations. Options:

1

2

Parameter “Disable function”

This parameter is visible when binary input functions are selected. Set trigger value to disable/enable contacts. Options:

Disable

Disable=1/Enable=0

Disable=0/Enable=1

5.5.Parameter window “Button”

This series of products has several panels, including 2-gang, 3-gang and 4-gang. The function of the button panels is similar, so the 4-gang panel is used as an example below.

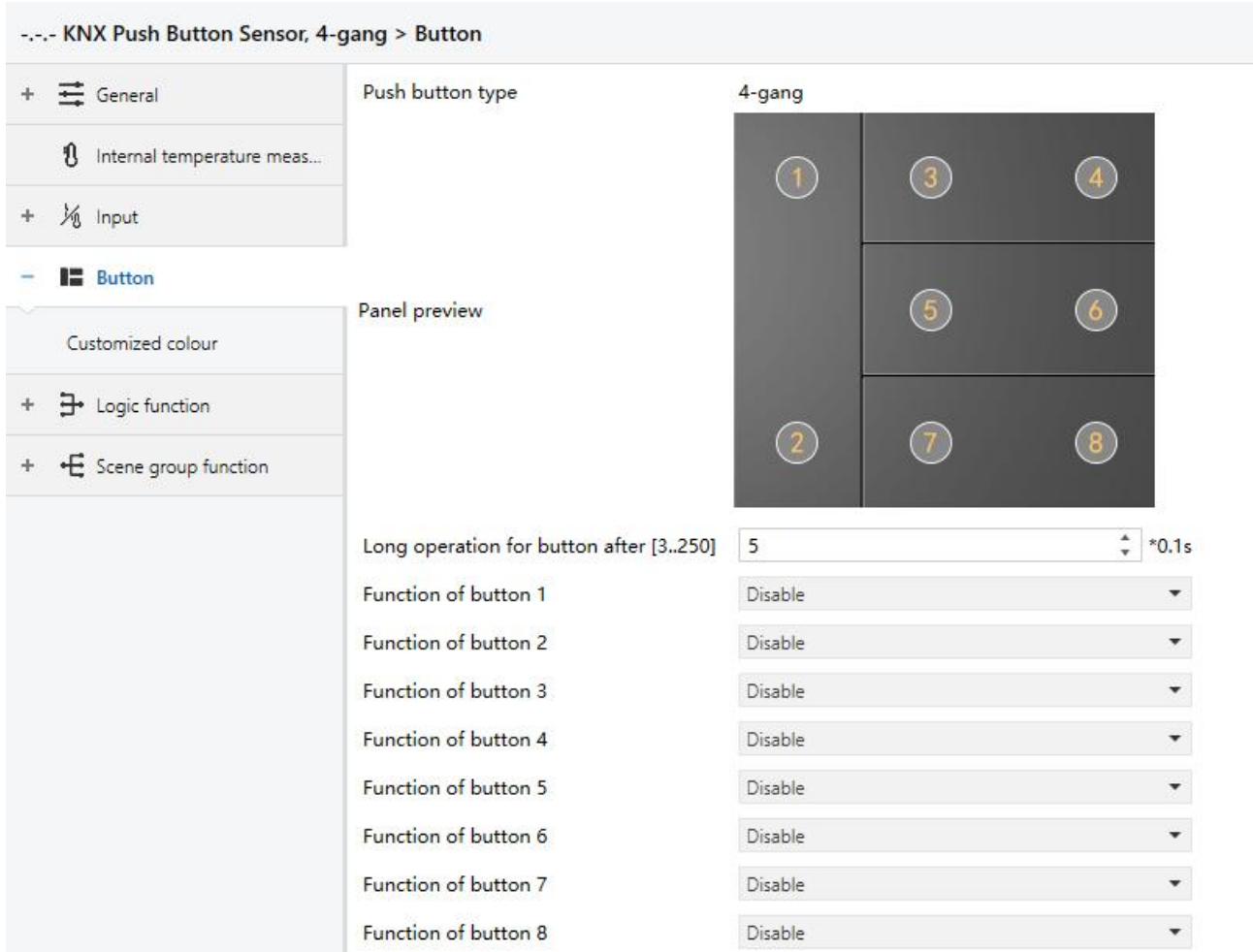

Fig.5.4 “Button” parameter window

Parameter “Push button type”

This parameter is for setting the push button type. Under the parameter, it displays the panel preview picture according the push button type. If the type is 4-gang, shown as Fig.5.4.

Parameter “ Long operation for button after [3..250]*0.1s”

Button operation is distinguished between long and short operation as default, this parameter is for setting the valid time for long operation. So, when you press longer than the time set here, it will be identified as long operation, otherwise, it will be taken as short operation. Options: **3..250**

Parameter "Function of button x"(x=1~8)

This parameter is for setting the function of button. Options:

- | | |
|-----------------------------------|---------------------------|
| Disable | Scene control |
| Switch | Blind |
| Dimming | Shift register |
| RGB lighting | Multiple operation |
| RGBW lighting | Delay mode |
| Colour temperature control | RTC operation mode |
| Value sender | String(14bytes) |

Chapters as follow explain the button function separately.

5.5.1. Switch function



Fig.5.4.1 Parameter setting of switch function

Parameter "Description (max 30char.)"

This parameter is for setting the name description for the current button function, up to input 30 chapters.

Parameter "Distinction between short and long operation"

This parameter is for setting whether to distinction the contact operation between short and long operation. Options:

- No**
- Yes**

When select "Yes", the operation reaches a certain time to determine whether the operation is a long or short operation before the contact performs the setting action.

Parameter "Reaction on short/press operation"**Parameter "Reaction on long/release operation"**

These parameters are for setting the performed actions when press/release the contact or long/short operation. The object value is updated when the input is determined. Options:

No reaction

OFF

ON

TOGGLE

No reaction: No telegrams have been sent.

ON: Send the on telegram.

OFF: Send the off telegram.

TOGGLE: Each operation will alternate between on and off. For example, if the last telegram was sent (or received) for on, then the next operation will trigger a telegram for off. When the switch is operated again, it will send a telegram for on etc., So the switch will always remember the previous state and covert to opposite value during next operation.

Parameter "Number of objects"

This parameter is visible when the parameter "Reaction on long/release operation" is not selected "No reaction". Set the number of objects when short/long or press/release operation:

1

2

Parameter "Disable function"

This parameter is for setting trigger value to disable/enable contacts. Options:

Disable

Disable=1/Enable=0

Disable=0/Enable=1

Parameter "Status LED indication when button disable"

This parameter is visible when previous parameter is selected "Disable=1/Enable=0" or

“Disable=0/Enable=1”. Set the LED indication status when button disable. Options:

No

Flashing

No: no indication and stay the normal indication status;

Flashing: always flashing until receive the “Enable” telegram it will back to normal indication, the flashing period is 1s on and 1s off.

—Parameter “LED indication colour”

This parameter is visible when previous parameter is selected “Flashing”. Set the LED indication colour, and when it is a customized colour, you need to configure the the colour in the “Customized colour” interface.Options:

Red

Orange

Green

Cyan blue

Blue

Customized colour 1

White

Customized colour 2

Yellow

Customized colour 3

Cyan

Customized colour 4

Magenta

Customized colour 5

Repeat parameters will not be illustrated in next chapters; the usage is similar.

5.5.2. Dimming function

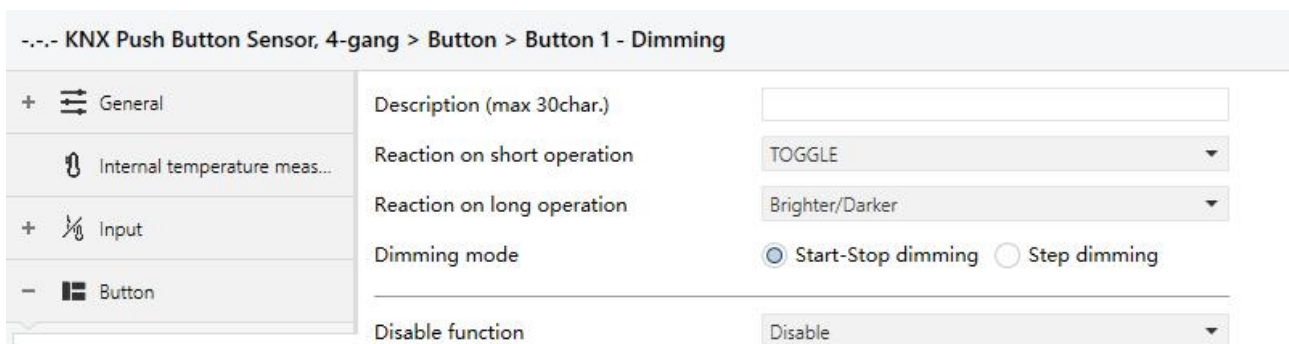

Fig.5.4.2 Parameter setting of dimming function

Parameter “Reaction on short operation”

This parameter is for setting the the switch value to send when short operation. Options:

No reaction

OFF

ON

TOGGLE

No reaction: No telegrams have been sent.

ON: Send the on telegram.

OFF: Send the off telegram.

TOGGLE: Each operation will alternate between on and off.

Parameter "Reaction on long operation"

This parameter is for setting the the relative dimming value to send when long operation, with dimming brightness or darker; when release the contact stop dimming. Options:

No reaction

Brighter

Darker

Brighter/Darker

No reaction: No telegrams have been sent.

Brighter: The dimming up value will be sent.

Darker: The dimming down value will be sent.

Brighter/Darker: Dimming up and down will be sent alternately.

Note: In "TOGGLE" mode of this parameter setting, the value sent will be linked. For example, if the last value is switching on status, then it will be dimmed down in next dimming operation; if the last value is switching off, then it will be dimmed up in next dimming operation.

Parameter "Dimming mode"

This parameter is visible when previous parameter is not "No reaction". Set the way of relative dimming. Options:

Start-Stop dimming

Step dimming

Start-stop dimming: The dimming mode will be start-stop, a dimming up or down telegram will be

sent when the dimming starts, and a stop telegram will be sent when dimming ends. Here the dimming telegram will not be sent cyclically.

Steps dimming: The dimming mode will be a step one and the dimming telegram will be sent cyclically. When dimming ends, a stop dimming telegram will be sent immediately.

—Parameter “ Step size”

This parameter is visible when the dimming way is selected “Step dimming”. Set a cyclically sending dimming telegram which changes the brightness percentage, Options:

100%

50%

...

1.56%

—Parameter “ Interval of tele. cyclic send [0..25,0=send once]*0.1s”

This parameter is visible when the dimming way is selected “Step dimming”. Set intervals of two cyclically sending dimming telegram. Options: **0..25, 0=send once**

5.5.3. RGB lighting

The screenshot shows the configuration interface for a KNX Push Button Sensor, 4-gang, specifically for Button 1 - RGB. The interface is divided into a left sidebar with navigation options and a main configuration area. The sidebar includes 'General', 'Internal temperature meas...', 'Input', and 'Button'. The main area shows the following settings:

- Description (max 30char.): [Empty text field]
- Object datatype of absolute brightness: 1x3byte 3x1byte
- Reaction on short operation: TOGGLE
- Reaction on long operation: Absolute value
- RGB Value: #FFFFFF
- Disable function: Disable

Fig.5.4.3 Parameter setting of RGB lighting function

Parameter “Object datatype of absolute brightness”

This parameter is for setting the object datatype for RGB lighting. Options:

1x3byte

3x1byte

Parameter "Reaction on short operation"

Parameter "Reaction on long operation"

These parameters are for setting the performed actions when long/short operation. Options:

No reaction

OFF

ON

TOGGLE

Absolute value

Parameter "RGB value"

This parameter is visible when previous parameter is selected "Absolute value". Set the sending RGB value when long/short operation. Options: **#0000..#FFFF**

5.5.4. RGBW lighting

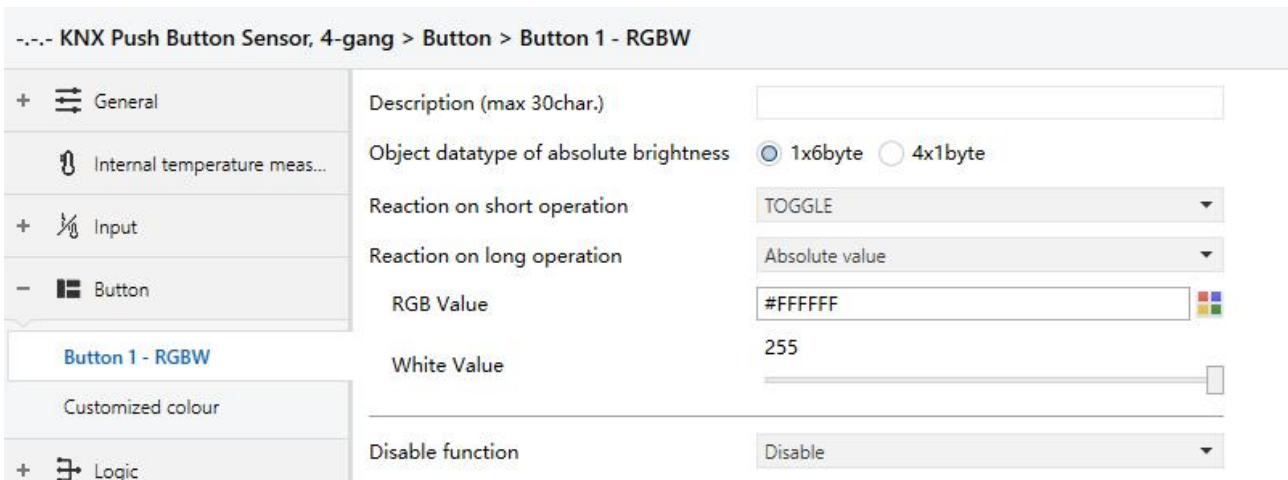

Fig.5.4.4 Parameter setting of RGBW lighting function

Parameter "Object datatype of absolute brightness"

This parameter is for setting the object datatype for RGBW lighting. Options:

1x6byte

4x1byte

Parameter "Reaction on short operation"

Parameter "Reaction on long operation"

These parameters are for setting the performed actions when long/short operation. Options:

No reaction

OFF

ON

TOGGLE

Absolute value

Parameter "RGB value"

This parameter is visible when previous parameter is selected "Absolute value". Set the sending RGB value when long/short operation. Options: **#0000..#FFFF**

Parameter "White Value"

This parameter is visible when previous parameter is selected "Absolute value". Set the sending white brightness value when long/short operation. Options: **0..255**

5.5.5. Colour temperature control

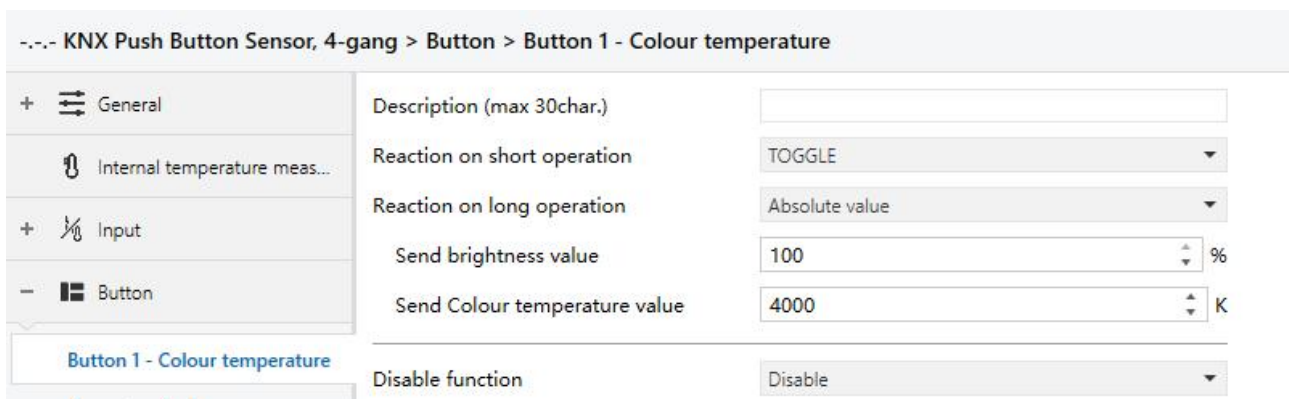

Fig.5.4.5 Parameter setting of colour temperature control function

Parameter "Reaction on short operation"

Parameter "Reaction on long operation"

These parameters are for setting the performed actions when long/short operation. Options:

No reaction

OFF

ON

TOGGLE

Absolute value

Parameter "Send brightness value"

This parameter is visible when previous parameter is selected "Absolute value". Set the sending brightness value when long/short operation. Options: **0..100%**

Parameter "Send Colour temperature value"

This parameter is visible when previous parameter is selected "Absolute value". Set the sending colour temperature value when long/short operation. Options: **1000...10000K**

5.5.6. Value sender function

--- KNX Push Button Sensor, 4-gang > Button > Button 1 - Value sender

+ General	Description (max 30char.)	<input type="text"/>
Internal temperature meas...	Reaction on short operation	1bit value[ON/OFF] ▼
+ Input	Value 1	<input type="radio"/> OFF <input checked="" type="radio"/> ON
- Button	Reaction on long operation	2bit value[0..3] ▼
	Value 2	2 ▲▼
Button 1 - Value sender	Disable function	Disable ▼
Customized colour		

Fig.5.4.6 Parameter setting of value sender

Parameter "Reaction on short operation"

Parameter "Reaction on long operation"

These parameters are for setting the datatype to send when long/short operation. Options:

No reaction

1bit value[On/Off]

2bit value[0..3]

4bit value[0..15]

1byte value[0..255]

2byte value[0..65535]

2byte float value

4byte value[0..4294967295]

4byte float value

Parameter "Value 1/2"

These parameters are visible when "No reaction" is not selected. Set the data value to send when perform short/long operation. Range of value is determined according to the previous parameter selected datatype.

5.5.7. Scene function

The screenshot shows the configuration interface for a KNX Push Button Sensor, 4-gang, specifically for Button 1 - Scene. The interface is divided into a left sidebar with navigation options and a main configuration area. The sidebar includes 'General', 'Internal temperature meas...', 'Input', 'Button', 'Button 1 - Scene' (selected), and 'Customized colour'. The main configuration area has the following settings:

- Description (max 30char.): [Empty text field]
- Reaction on short operation: Recall scene (dropdown)
- 8 bit scene number: Scene No.1 (dropdown)
- Reaction on long operation: Store scene (dropdown)
- 8 bit scene number: Scene No.1 (dropdown)
- Number of objects: 1 2
- Disable function: Disable (dropdown)

Fig.5.4.7 Parameter setting of scene function

Parameter "Reaction on short operation"

Parameter "Reaction on long operation"

These parameters are for setting to recall or storage scene when long/short operation. Options:

No reaction

Recall scene

Store scene

Parameter "8 bit scene number"

This parameter is visible when "No reaction" is not selected. Set the scene number. Options:

Scene NO.1

Scene NO.2

Scene NO.3

...

Scene NO.64

Corresponding telegram is 0~63

Parameter "Number of objects"

This parameter is visible when the parameter "Reaction on long operation" is not selected "No reaction". Set the number of objects when short/long operation:

1

2

5.5.8. Blind function

--- KNX Push Button Sensor, 4-gang > Button > Button 1 - Blind

+	☰ General	Description (max 30char.)	<input type="text"/>
	🔌 Internal temperature meas...	Reaction on short operation	Stop(Adjust Up/Down) ▼
+	🔌 Input	Reaction on long operation	Stop(Adjust Up) ▼
-	☰ Button	Interval of tele. cyclic send [0..25,0=send once]	0 ▲▼ *0.1s
	Button 1 - Blind	Disable function	Disable ▼

Fig.5.4.8 Parameter setting of blind function

Parameter "Reaction on short operation"

Parameter "Reaction on long operation"

These parameters are for setting to performed actions when long/short operation. Options:

No reaction

Up

Down

Up/Down

Stop(Adjust Up)

Stop(Adjust Down)

Stop(Adjust Up/Down)

No reaction: No reaction is performed.

Up: The curtains/blinds will be opened or moved up.

Down: The curtains/blinds will be closed or moved down.

Up/Down: Alternately open/close or move up/down the curtains/blinds.

Stop (Adjust Up): Stop the curtain movement or move up the angle of blinds.

Stop (Adjust Down): Stop the curtain movement or move down the angle of blinds.

Stop (Adjust Up/Down): Stop the curtain movement or move up/down the angle of blinds alternately.

Parameter "Interval of tele. cyclic send [0..25,0=send once]*0.1s"

This parameter is visible when previous parameter is selected "Stop...". Set the time interval of cyclical blinds angle adjustment telegram sent. Options: **0..25,0=send once**

5.5.9. Shift register function

--- KNX Push Button Sensor, 4-gang > Button > Button 1 - Shift register

+ [Menu] General	Description (max 30char.)	<input type="text"/>
[Icon] Internal temperature meas...	Shift type	<input checked="" type="radio"/> Shift by step value <input type="radio"/> Shift without step value
+ [Icon] Input	Value begin with	<input type="text" value="0"/>
- [Icon] Button	Value end with (must be larger than value begin with)	<input type="text" value="10"/>
[Icon] Button 1 - Shift register	Step size	<input type="text" value="2"/>
Customized colour	Direction	From lowest to highest and cyclically
+ [Icon] Logic function	Reset function	<input checked="" type="radio"/> Disable <input type="radio"/> Enable by long operation
+ [Icon] Scene group function	Disable function	Disable
+ [Menu] General	Description (max 30char.)	<input type="text"/>
[Icon] Internal temperature meas...	Shift type	<input type="radio"/> Shift by step value <input checked="" type="radio"/> Shift without step value
+ [Icon] Input	Object datatype	1byte unsigned value
- [Icon] Button	Shift number	<input type="text" value="4"/>
[Icon] Button 1 - Shift register	Value 1	<input type="text" value="0"/>
Customized colour	Value 2	<input type="text" value="1"/>
+ [Icon] Logic function	Value 3	<input type="text" value="2"/>
+ [Icon] Scene Group function	Value 4	<input type="text" value="3"/>
	Direction	From lowest to highest and cyclically
	Reset function	<input checked="" type="radio"/> Disable <input type="radio"/> Enable by long operation
	Disable function	Disable

Fig.5.4.9 Parameter setting of shift register function

Parameter "Shift type"

This parameter is for setting the shift type. Options:

Shift by step value

Shift without step value

Shift by step value: Here the lowest value and highest value of shift can be set, the value increased (from lowest to highest) or decreased (from highest to lowest) from every shift can also be set.

Shift without step value: When there's no step value, the actual value sent by each shift can be set (max. 10 value), in every operation one value will be sent.

Three parameters as follow are visible when "Shift by step value" is selected

—Parameter "Value begin with"

This parameter is for setting the lowest value of the shift. Options: **0..240**

—Parameter "Value end with(must be larger than value begin with)"

This parameter is for setting the highest value of the shift. Options: **1..250**

The highest value must be larger than lowest value.

—Parameter "Step size"

This parameter is for setting the increase (from low to high) or decrease (from high to low) value.

Options: **0..240**

Parameters as follow are visible when "Shift without step value" is selected

Parameter "Object datatype"

This parameter is for setting the object datatype for the shift object. Option is only **1byte unsigned value**

—Parameter "Shift number"

This parameter is for setting the number of shift, up to set maximum 10 values, Options: **0/1/2../10**

—Parameter "Value x"(x=1~10)

This parameter is for setting the value when each shift operation to send. Options: **0..255**

Parameter "Direction"

This parameter is for setting the shift direction. Options:

From lowest to highest and stop to the end

From highest to lowest and stop to the begin

From lowest to highest and cyclically

From highest to lowest and cyclically

From lowest to highest and stop to the end: Shift from low to high.

From highest to lowest and stop to the begin: Shift from high to low.

From lowest to highest and cyclically: once to the end value, shift direction starts over again and constantly cycling from low to high operation.

From highest to lowest and cyclically: once to the start value, shift direction starts over again and constantly cycling from high to low operation.

Parameter "Reset function"

This parameter is for setting whether to enable shift reset function. Options:

Disable

Enable by long operation

Disable: Not possible to reset shift;

Enable by long operation: Possible to reset shift by long operation, when reset, shift will start new.

5.5.10. Multiple operation function

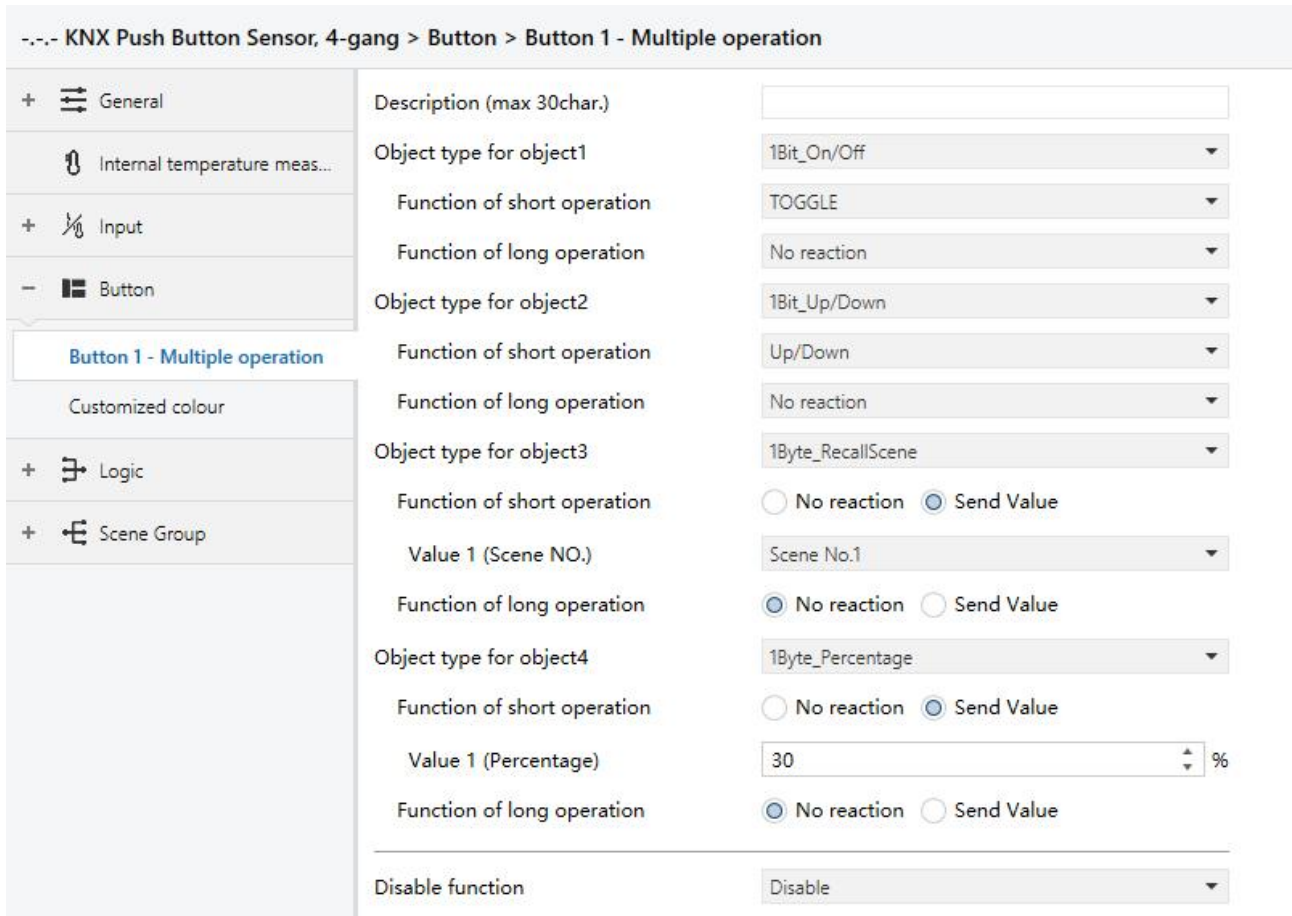

Fig.5.4.10 Parameter setting of multiple operation function

Parameter "Object type for object x" (x=1~4)

This parameter is for setting the datatype when long/short operation to send. Options:

- Disable**
- 1Bit_On/Off**
- 1Bit_Up/Down**
- 1Byte_RecallScene**
- 1Byte_StoreScene**
- 1Byte_Percentage**
- 1Byte_Unsigned value**

Parameter "Function of short operation"

Parameter "Function of long operation"

This parameter is for setting the specific values to send when perform the operation, either no

action or sending value (the specific value will be set in next parameter).

—Parameter “Value x...”(x=1~2)

This parameter is visible when object type is selected “1byte_RecallScene”, “1byte_StoreScene”, “1byte_Percentage”, “1byte_Unsigned value”. Set sending values when perform operations. The range of value is up to the datatype selected by the parameter before last one.

5.5.11. Delay mode function

--- KNX Push Button Sensor, 4-gang > Button > Button 1 - Delay mode

+ General	Description (max 30char.)	<input type="text"/>
Internal temperature meas...	Object type for short operation	1Bit_On/Off
+ Input	Send mode	No action when operation,delay then send value1
- Button	Delay time [0..6500]	10 s
Button 1 - Delay mode	Value 1	<input checked="" type="radio"/> OFF <input type="radio"/> ON
Customized colour	Value 2	<input type="radio"/> OFF <input checked="" type="radio"/> ON
+ Logic	Object type for long operation	4Bit_Dimming
+ Scene Group	Send mode	No action when operation,delay then send value1
	Delay time [0..6500]	10 s
	Value 1	1
	Value 2	0
	Disable function	Disable

Fig.5.4.11 Parameter setting of delay mode function

Parameter “Object type for short operation”

Parameter “Object type for long operation”

These parameters are for setting the datatype when long/short operation to send. Options:

- Disable**
- 1Bit_On/Off**
- 4Bit_Dimming**
- 1Byte_Unsigned value**

—Parameter “Send mode”

This parameter is for setting the send mode. Options:

No action when operation, delay then send value1

No action when operation, delay then send value2

Send value1 when operation, delay then send value2

Send value2 when operation, delay then send value1

Parameter "Delay time [0..6500]s"

This parameter is for setting the delay time. Options: **0..6500**

Parameter "Value x" (x=1~2)

This parameter is for setting the value 1/2 to send. The range of value is up to the datatype selected by the parameters.

5.5.12. RTC mode function

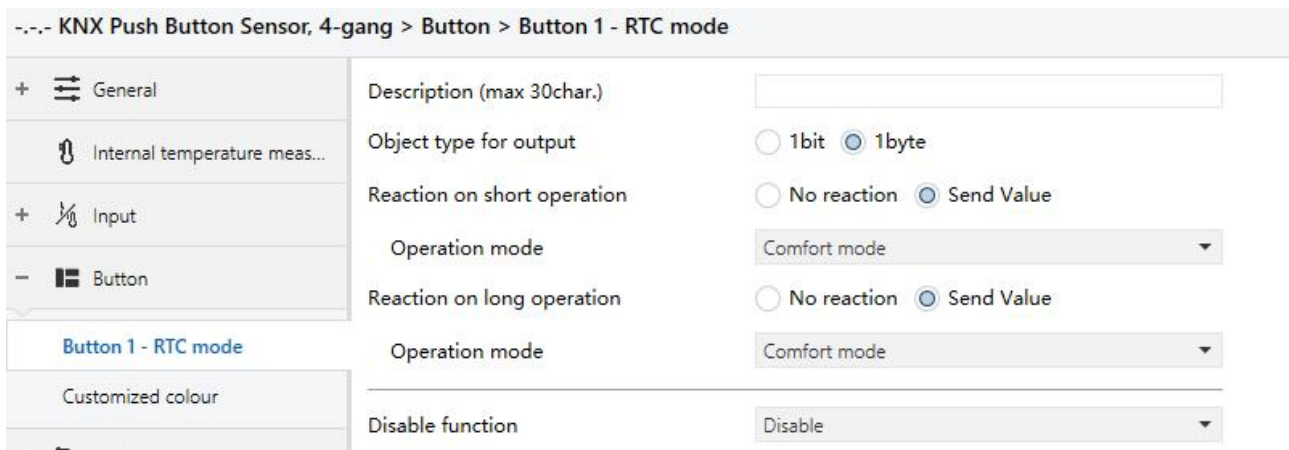

Fig.5.4.12 Parameter setting of RTC mode function

Parameter "Object type for output"

This parameter is for setting object datatype for output. Options:

1bit

1byte

Parameter "Reaction on short operation"

Parameter "Reaction on long operation"

These parameters are for setting the performed operation when long/short operation. Options:

No reaction

Send Value

Parameter "Operation mode"

This parameter is visible when "No reaction" is not selected. Set the operation mode of RTC.

Options:

Auto

Comfort mode

Standby mode

Economy mode

Frost/heat protection

Activate corresponding modes when object telegram is 1, and not activated when object telegram is 0. All is standby mode when all objects telegram are 0.

Note: There is no "Auto" selected when output object is 1 bit.

Parameter "Standby mode object"

Consider that some products will not have this object, so that set the object, send telegram 1 when standby mode.

This parameter is visible when 1bit is selected. Set whether to enable the object of standby mode.

Options:

Disable

Enable

5.5.13. String function

--- KNX Push Button Sensor, 4-gang > Button > Button 1 - String

+ General

Internal temperature meas...

+ Input

- Button

Button 1 - String

Customized colour

Description (max 30char.)

Reaction on short operation No reaction Send Value

String (14byte) value Hello, world !

Reaction on long operation No reaction Send Value

String (14byte) value Hello, world !

Disable function Disable

Fig.5.4.13 Parameter setting of string function

Parameter "Reaction on short operation"

Parameter "Reaction on long operation"

These parameters are for setting the performed operation when long/short operation. Options:

No reaction

Send Value

Parameter "String (14byte) value"

This parameter is visible when "No reaction" is not selected. Set the string value to send.

5.5.14. LED indication function

Status LED indication	Control by button switch object
When object value="0", LED is	OFF
When object value="1", LED is	Blue
Control by button switch object	
Status LED indication	Control by external object
External object datatype	<input checked="" type="radio"/> 1bit <input type="radio"/> 1byte
When object value="0", LED is	OFF
When object value="1", LED is	Blue
Status LED indication	Control by external object
External object datatype	<input type="radio"/> 1bit <input checked="" type="radio"/> 1byte
Threshold value is	50
If object value<threshold value, LED is	OFF
If object value=threshold value, LED is	Red
If object value>threshold value, LED is	OFF
Control by external object	
Status LED indication	Indicate button press
When press the button,indicator is	<input checked="" type="radio"/> On <input type="radio"/> Flashing
On duration time is	1s
LED indication colour	Red
Status LED indication	Indicate button press
When press the button,indicator is	<input type="radio"/> On <input checked="" type="radio"/> Flashing
Flashing period time is	0.8 s
Normal indication is	<input checked="" type="radio"/> OFF <input type="radio"/> ON
LED indication colour	Red
Indicate button press	
Status LED indication	Always on
LED indication colour	Red
Always on	

Fig.5.4.14 Parameter setting of LED indication function

Parameter "Status LED indication"

This parameter is for setting the LED indication status. When button function set with switch function, such as switch, dimming function. Options:

Disable

Control by button switch object

Control by external object

Indicate button press

Always on

There is no option "Control by button switch object" when not with switch function, such as scene, blind, value sender, delay mode and etc.

Parameters as follow are visible when LED indication status is selected "Control by button switch object".

—Parameter "When object value="0", LED is"

—Parameter "When object value="1", LED is"

These parameters are for setting the LED indication colour according to switch function and dimming function. Options:

OFF	Orange
Red	Cyan blue
Green	Customized colour 1
Blue	Customized colour 2
White	Customized colour 3
Yellow	Customized colour 4
Cyan	Customized colour 5
Magenta	

Parameters as follow are visible when LED indication status is selected "Control by external object".

—Parameter "External object datatype"

This parameter is for setting the external object datatype. Options:

- 1bit**
- 1byte**

Note: The object will send read request when the device power on, indicate according to the response value, and no handled when no receive a response.

Two parameters as follow are visible when 1 bit is selected.

—Parameter “When object value=“0”, LED is”

—Parameter “When object value=“1”, LED is”

These parameters are for setting the LED indication colour according to 1 bit object value from the bus. Options:

OFF	Orange
Red	Cyan blue
Green	Customized colour 1
Blue	Customized colour 2
White	Customized colour 3
Yellow	Customized colour 4
Cyan	Customized colour 5
Magenta	

Four parameters as follow are visible when 1 byte is selected.

—Parameter “Threshold value is”

This parameter is for setting the threshold value. Options: **1..255**

—Parameter “If object value<threshold value, LED is”

—Parameter “ If object value=threshold value, LED is”

—Parameter “ If object value>threshold value, LED is”

These parameters are for setting the LED indication colour according to the comparison of both the object value and the threshold value. Options:

OFF	Orange
Red	Cyan blue
Green	Customized colour 1
Blue	Customized colour 2
White	Customized colour 3
Yellow	Customized colour 4

Cyan**Customized colour 5****Magenta**

Parameters as follow are visible when LED indication status is selected "Indicate button press".

—Parameter "When press the button, indicator is"

This parameter is for setting the LED indication status when press the button. Options:

On**Flashing**

Parameter as follow is visible when On is selected.

—Parameter "On duration time is"

This parameter is for setting the LED on duration time. Options:

500ms**1s****2s****3s**

Parameters as follow are visible when Flashing is selected.

—Parameter "Flashing period time is"

This parameter is for setting the LED flashing period time. options:

0.4s**0.8s****...****2.0s**

—Parameter "Normal indication is"

This parameter is for setting the LED normal indication when finish flashing. Options:

OFF**ON**

Parameter as follow is visible when LED indication status is selected “Indicate button press” or “Always on”.

Parameter “LED indication colour”

This parameter is for setting the LED indication colour. Options:

- | | |
|----------------|----------------------------|
| Red | Orange |
| Green | Cyan blue |
| Blue | Customized colour 1 |
| White | Customized colour 2 |
| Yellow | Customized colour 3 |
| Cyan | Customized colour 4 |
| Magenta | Customized colour 5 |

5.5.15. Parameter window “Customized colour”

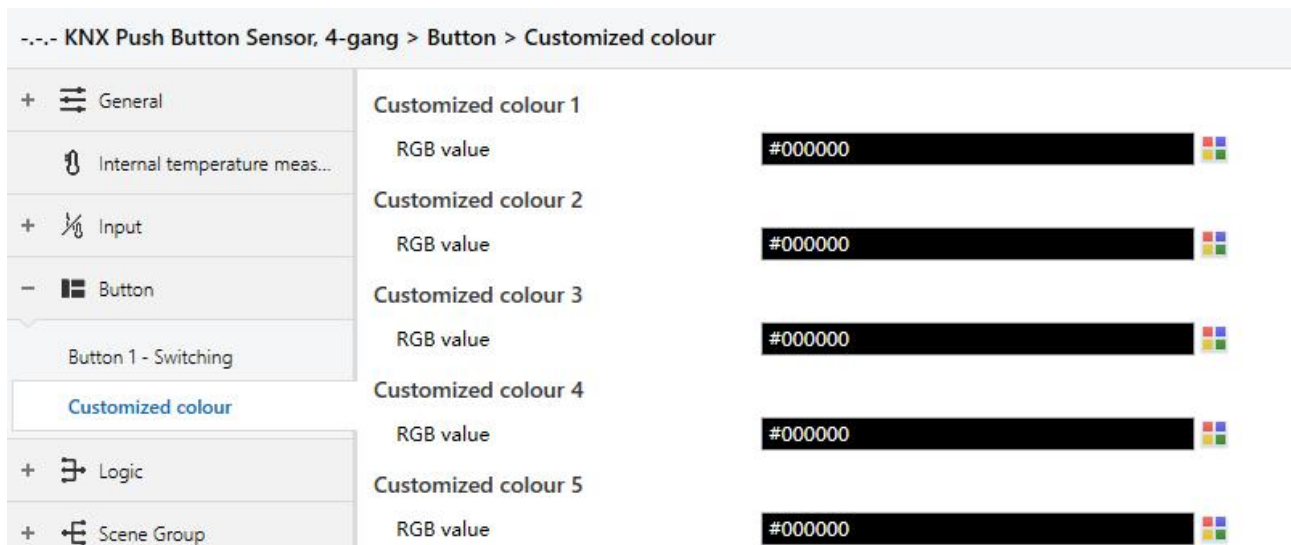

Fig.5.4.15 “Customized colour” parameter window

Customized colour x (x=1~5)

Parameter “RGB value”

This parameter is for setting the customized colour of LED indication, user up to define 5 colours.

Options: #000000#FFFFFF

5.6. Parameter window "Logic"

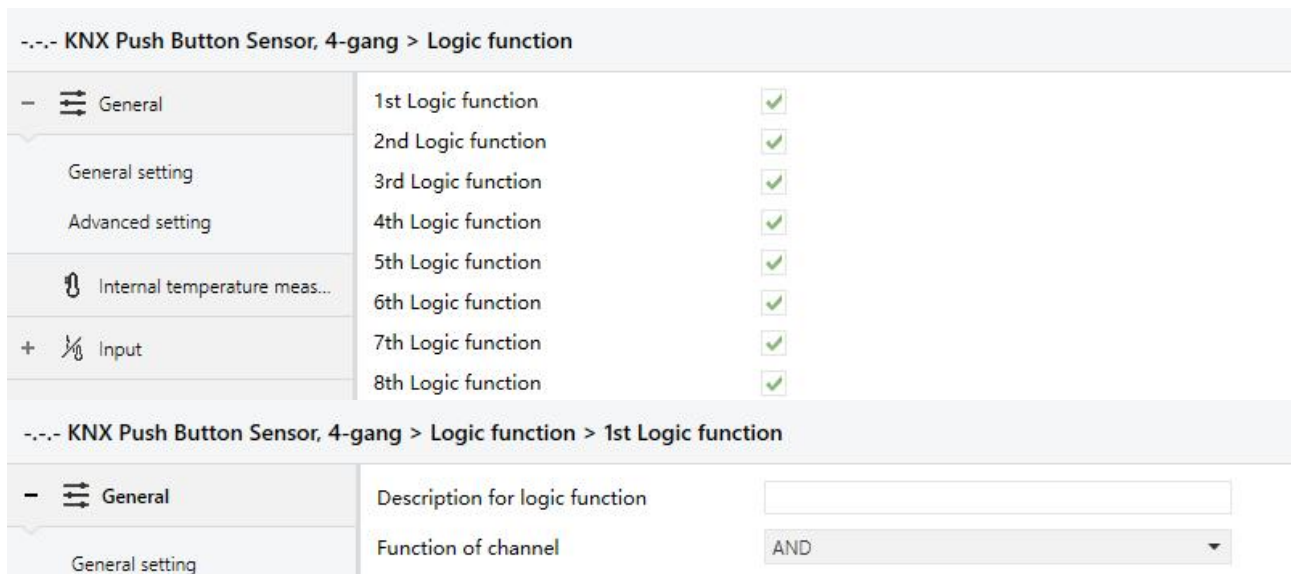

Fig.5.5 "Logic function setting" parameter window

Parameter "1st/2nd/3rd... Logic function"

This parameter is for setting the setting interface of logic function, display corresponding logic function page when select. Up to enable 8 logic functions.

Parameter "Description for logic function"

This parameter is for setting the name description for logic function, up to input 30 characters.

Parameter "Function of channel"

This parameter is for setting function of the channel. Options:

AND

OR

XOR

Gate forwarding

Threshold comparator

Format convert

Gate function

Delay function

Staircase lighting

AND/OR/XOR: as the parameter is similar to the communication object (only the logic algorithm is different), the following parameters taking one options for example.

5.6.1. Parameter window “AND/OR/XOR”

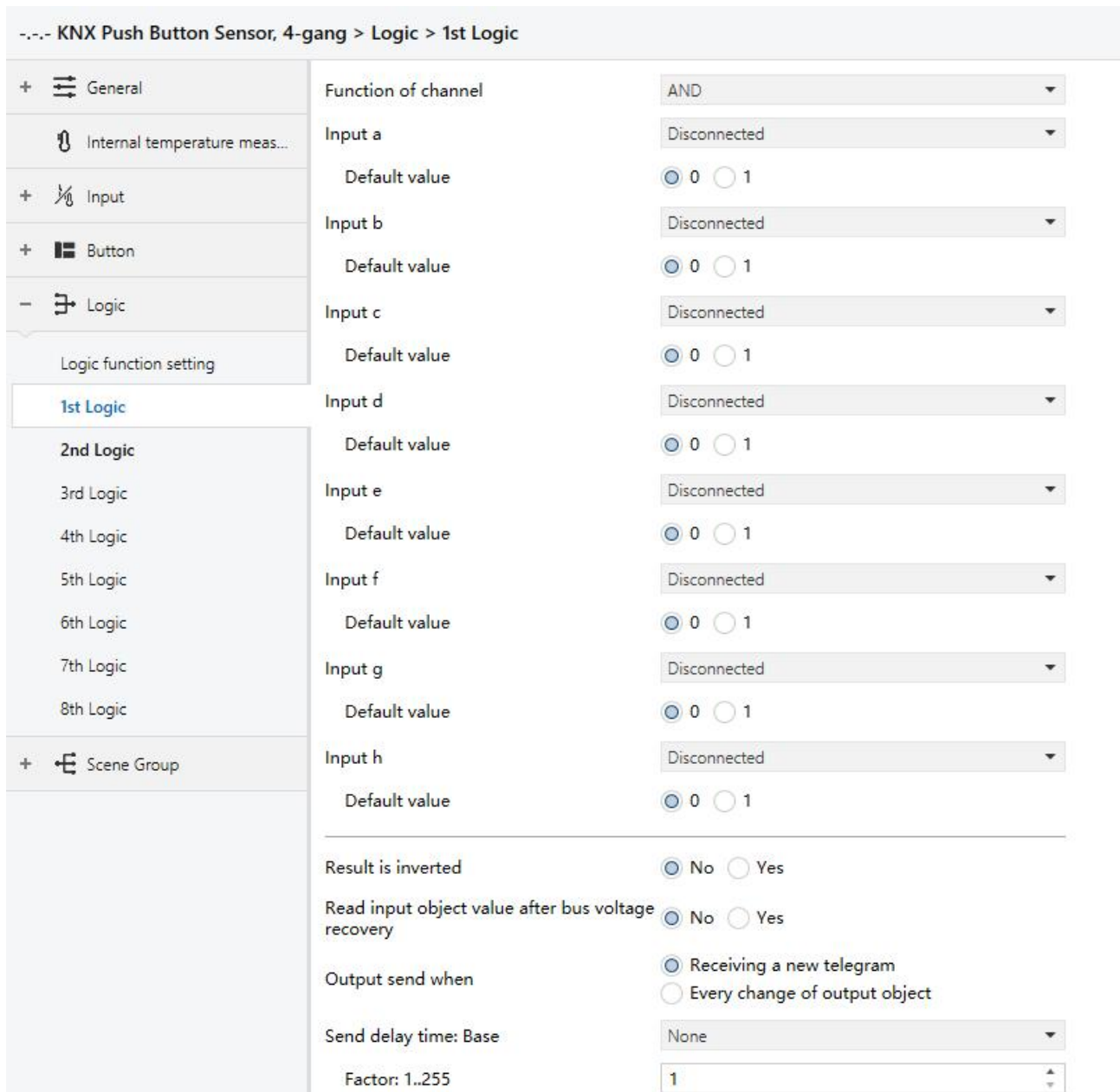

Fig.5.5.1 “AND/OR/XOR” parameter window

Parameter “Input a/b/c/d/e/f/g/h”

This parameter is for setting whether input x to calculate, whether to normally calculate or inverted calculate. Options:

Disconnected

Normal

Inverted

Disconnected: not to calculate;

Normal: to directly calculate the input value;

Inverted: invert the input value, then to calculate. **Note: not to invert the initiate value.**

Parameter "Default value"

This parameter is for setting the initial value of logic input x. Options:

0

1

Parameter "Result is inverted"

This parameter is for setting whether to invert the logic calculation result. Options:

No

Yes

No: output directly;

Yes: output after inverting.

Parameter "Read input object value after bus voltage recovery"

This parameter is for setting whether to send the read request to the logic input object after device voltage recovery or finish programming. Options:

No

Yes

Parameter "Output send when"

This parameter is for setting the condition of sending logic result. Options:

Receiving a new telegram

Every change of output object

Receiving a new telegram: every time the object received a new input value will the logic result be sent to the bus;

Every change of output object: only when logic result has changed will it be sent to the bus.

Tip: when in the first time to logic calculate, the logic result will be sent even if it has no change.

Parameter "Send delay time"

Base: None

0.1s

1s

...

10s

25s

Factor: 1..255

This parameter is for setting the delay time for sending the logic calculation result to the bus. Delay time = Base × Factor, if option “None” of Base is selected, then there is no delay.

5.6.2. Parameter window “Gate forwarding”

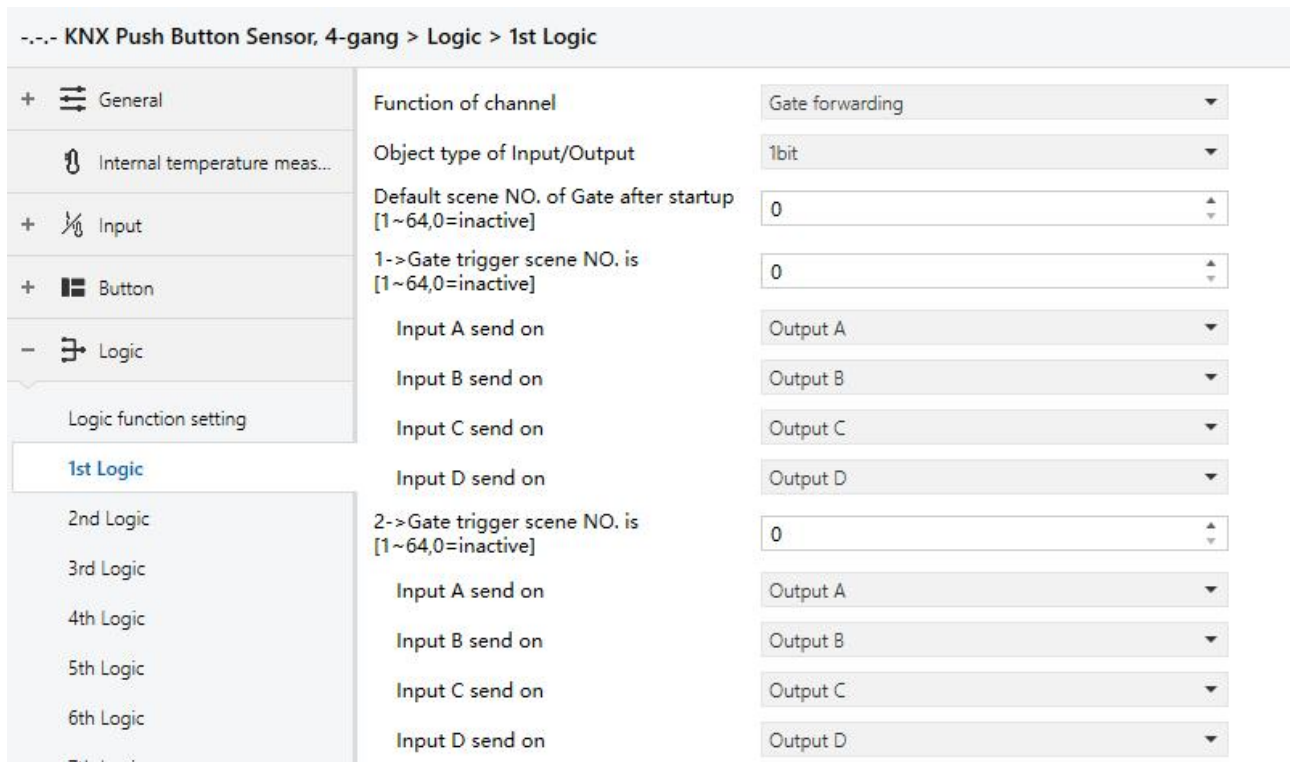

Fig.5.5.2 “Gate forwarding” parameter window

Parameter “Object type of Input/Output”

This parameter is for setting the object type of input/output. Options:

1bit

4bit

1byte

Parameter “Default scene NO. of Gate after startup [1~64,0=inactive]”

This parameter is for setting the initial scene where logical gate forwarding can be performed by

default after device starts, which needs to be configured in the parameters. Options: **1..64, 0=inactive**

Note: gate scene is recommended to be selected before operating, or it will enable the initiate scene by default.

Parameter "z->Gate trigger scene NO. is [1~64,0=inactive]" (z=1~8)

This parameter is for setting scene number of logic gate forwarding. Up to 8 trigger scene number can be set for each logic. Options: **1..64, 0=inactive**

Parameter "Input A/B/C/D send on"

This parameter is for setting the output of input X (X=A/B/C/D) after gate forwarding. Options:

Output A

Output B

...

Output B,C,D

According to the options, one input can be forwarded into one or more outputs, the output value is the same as the input value.

5.6.3. Parameter window "Threshold comparator"

Fig.5.5.3 "Threshold comparator" parameter window

Parameter "Threshold value data type"

This parameter is for setting the threshold value data type. Options:

4bit value (DPT3.007)	4byte unsigned value[0..4294967295]
1byte unsigned value (DPT5.010)	Ext. temperature value (DPT 9.001)
2byte unsigned value (DPT7.001)	Ext. humidity value (DPT 9.007)
2byte signed value (DPT8.x)	Illuminance value (DPT 9.004)
2byte float value (DPT9.x)	

Parameter "Threshold value "

This parameter is for setting threshold value, the range depends on the data type. Options:

4bit value (DPT3.007) 0..15 / 1byte unsigned value (DPT5.010) 0..255 /

2byte unsigned value (DPT7.001) 0..65535 / 2byte signed value (DPT8.x) -32768..32767 /

2byte float value (DPT9.x) -670760...670760 / 4byte unsigned value[0..4294967295]

0..4294967295 /

Ext. temperature value (DPT 9.001) -20..95°C / Ext. humidity value (DPT 9.007) 0..100% /

Illuminance value (DPT 9.004) 0..65535lux

Parameter "Hysteresis threshold value"

This parameter is visible when object datatype is selected "2byte float value (DPT9.x)", "Illuminance value (DPT 9.004)". Set the hysteresis threshold value. Options: **0..500**

Parameter "If Object value<Threshold value"

Parameter "If Object value=Threshold value"

Parameter "If Object value!=Threshold value"

Parameter "If Object value>Threshold value"

Parameter "If Object value<=Threshold value"

Parameter "If Object value>=Threshold value"

This parameter is for setting the logic result value that should be sent when threshold value Less than, equal to, not equal to, greater than, less than or equal to the setting valve. When object datatype is selected "2byte float value (DPT9.x)", can only set the object value less than or greater than threshold value. Options:

Do not send telegram

Send value "0"

Send value "1"

Do not send telegram: not consider to select this option;

Send value "0"/"1": when condition is satisfied, send telegram 0 or 1.

If there is a conflict between the setting options between parameters, the base on the value that should be sent when reach the final parameter condition. **For example: parameter "If Object value=Threshold value" is set to be "Send value "0" "; parameter "If Object value<=Threshold value" is set to be "Send value "1" "; when object value is equal to the threshold value, then the logic result will send "1".**

Parameter "Output send when"

This parameter is for setting the condition of sending logic result. Options:

Receiving a new telegram

Every change of output object

Receiving a new telegram: every time the object received a new input value will the logic result be sent to the bus;

Every change of output object: only when logic result has changed will it be sent to the bus.

Tip: when in the first time to logic algorithm, the logic result will be sent even if it has no change.

Parameter "Send delay time"

Base: **None**

0.1s

1s

...

10s

25s

Factor: **1..255**

This parameter is for setting the delay time for sending the logic algorithm result to the bus. Delay time = Base x Factor, if option "None" of Base is selected, then there is no delay.

5.6.4. Parameter window "Format convert"

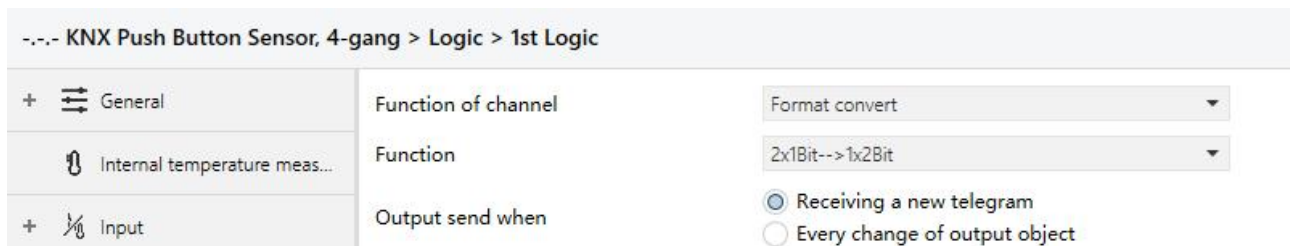

Fig.5.8.4 "Format convert" parameter window

Parameter "Function"

This parameter is for setting the format convert type. Options:

2x1bit-->1x2bit

8x1bit-->1x1byte

1x1byte-->1x2byte

2x1byte-->1x2byte

2x2byte-->1x4byte

1x1byte-->8x1bit

1x2byte-->2x1byte

1x4byte-->2x2byte

1x3byte-->3x1byte

3x1byte-->1x3byte

Parameter "Output send when"

This parameter is for setting the condition of sending logic result. Options:

Receiving a new telegram

Every change of output object

Receiving a new telegram: every time the object received a new input value will the logic result be sent to the bus;

Every change of output object: only when logic result has changed will it be sent to the bus.

Tip: when in the first time to logic algorithm, the logic result will be sent even if it has no change.

5.6.5. Parameter window "Gate function"

Fig.5.5.5 "Gate function" parameter window

Parameter "Object type of Input/Output"

This parameter is for setting the object type of input/output. Options:

1bit[On/Off]

1byte[0..100%]

1byte[0..255]

2byte[Float]

2byte[0..65535]

Parameter "Filter function"

This parameter is visible when "1bit[On/Off]" is selected. Set whether to filter On or Off telegram, only pass one of them or pass all. Options:

Deactivate

On filter out

Off filter out

Deactivate: Do not filter the On or Off telegrams;

On filter out: Off can pass, On cannot pass;

Off filter out: On can pass, Off cannot pass.

Parameter "Value output"

This parameter is visible when "1bit[On/Off]" is selected. Set whether to invert the value then output it. Options:

Normal

Inverted

Parameter "Gate object value"

This parameter is for setting whether to invert the gate object value then output it. Options:

Normal

Inverted

Parameter "Gate status after voltage recovery"

This parameter is for setting the gate status after power on. Options:

Disable

Enable

Parameter "Save input signal when gate close"

This parameter is for setting whether to save input signal on gate close. Options:

No

Yes

No: disable to save the input, the input values received during the gate closing period are ignored;

Yes: enable to save the input, the input values received during the gate closing period are output when gate is open (whether the input value is changed or not).

5.6.6. Parameter window "Delay function"

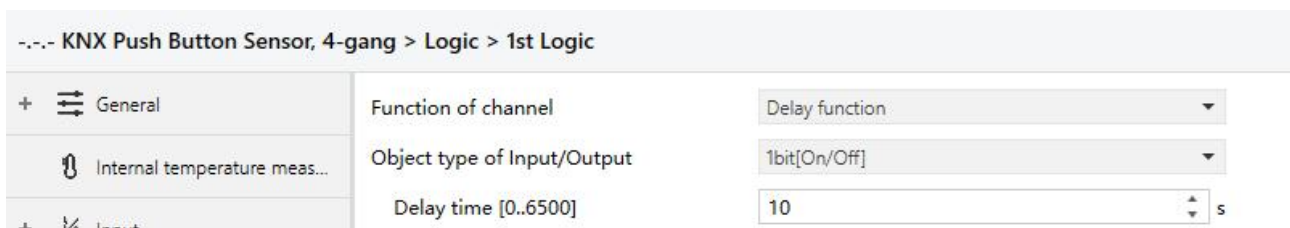

Fig.5.5.6 "Delay function" parameter window

Parameter "Object type of Input/Output"

This parameter is for setting the object type of input/output. Options:

1bit[On/Off]

1byte[0..100%]

1byte[0..255]

2byte[Float]

2byte[0..65535]

Parameter "Delay time [0..6500]s"

This parameter is for setting the delay time that output object forwards the value when the input object receives the telegram. Options: **0..6500**

Note: Receive telegram again in delay time, re-timing.

5.6.7. Parameter window "Staircase lighting"

--- KNX Push Button Sensor, 4-gang > Logic function > 1st Logic function

+ General	Description for logic function	<input type="text"/>
Internal temperature meas...	Function of channel	Staircase lighting ▼
+ Input	Trigger value	1 ▼
+ Button	Object type of output	<input checked="" type="radio"/> 1bit <input type="radio"/> 1byte
- Logic function	Duration time of staircase lighting [10..6500]	10 s
1st Logic function	Send value 1 when trigger	<input type="radio"/> OFF <input checked="" type="radio"/> ON
2nd Logic function	Send value 2 after duration time	<input checked="" type="radio"/> OFF <input type="radio"/> ON
	Retriggering	<input checked="" type="radio"/> Disable <input type="radio"/> Enable

Fig.5.5.7 "Staircase lighting" parameter window

Parameter "Trigger value"

This parameter is for setting the telegram value of the object "Trigger value". Options:

0

1

0 or 1

Parameter "Object type of output"

This parameter is for setting the object type of output. Options:

1bit

1byte

Parameter "Duration time of staircase lighting[10..6500]s"

This parameter is for setting duration time of staircase lighting after the stair light power on.

Options: **10..6500**

Parameter "Send value 1 when trigger"

Parameter "Send value 2 after duration time"

These parameters are for setting the value to send. Send value 1 when trigger, and then send value 2 after duration time. Options display according to the output object datatype.

When 1 bit, options:

OFF

ON

When 1 byte , options: **0..255**

Parameter "Retriggering"

This parameter is for setting whether to trigger re-timing when received trigger value in delay time.

Options:

Disable

Enable

5.7.Parameter window "Scene Group"

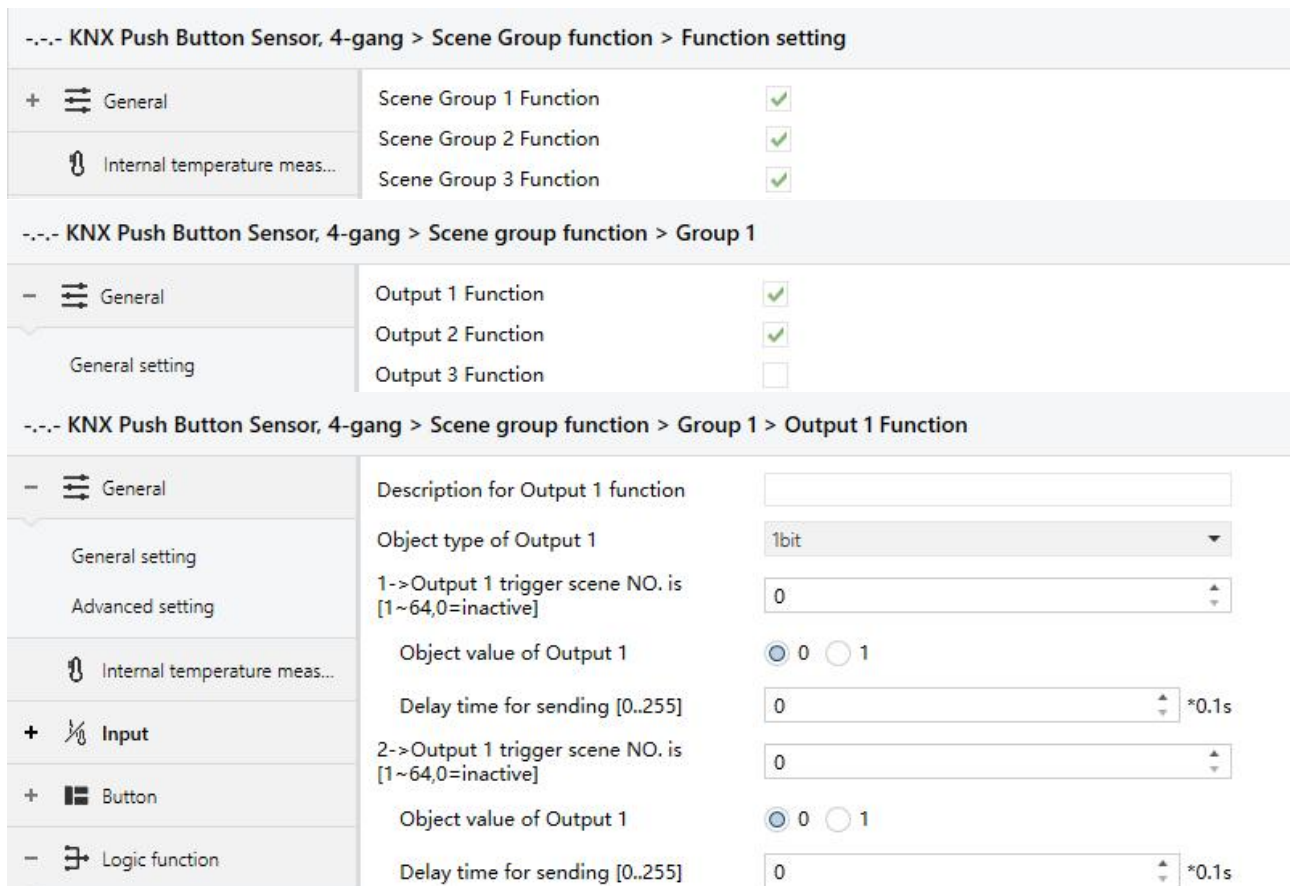

Fig.5.6 "Scene Group" parameter window

Parameter "Scene Group x Function" (x=1~8)

This parameter is for setting whether to enable scene group x function, up to 8 scene groups.

Parameter "Output y Function"(y=1~8)

This parameter is for setting whether to enable output y of scene group x, up to 8 output functions for each scene group.

As 8 group functions are the same, and 8 output functions of each group as well, the following description only about one output of a group.

Parameter "Description for Output y function"(y=1~8)

This parameter is for setting the name description for output y of group x, up to input 30 characters.

Parameter "Object type of Output y"(y=1~8)

This parameter is for setting the object type of output y of group x. Options:

1bit

1byte

2byte

Parameter "Object datatype"

This parameter is for setting the datatype of 1byte or 2byte.

When the datatype is 1byte, options:

1byte unsigned value

HVAC mode

When the datatype is 2byte, options:

2byte unsigned value

Temperature value

Parameter "z -> Output y trigger scene NO. is [1~64,0=inactive]"(z=1~8)

This parameter is for setting the triggered scene number of output y of group x. Up to 8 triggered scene of each output can be configured. Options:**0..64, 0=inactive**

Parameter "Object value of Output y"

This parameter is for setting the output value, the range depends on the data type of output y.

When the datatype is 1bit, options: **0..1**

When the datatype is 1byte-1byte unsigned value, options: **0..255**

When the datatype is 1byte-HVAC mode, options:

Comfort mode

Standby mode

Economy mode

Frost/heat protection

When the datatype is 2byte-2byte unsigned value, options: **0..65535**

When the datatype is 2byte-Temperature value, options:

-5°C

-4°C

...

45°C

Parameter "Delay time for sending $[0 \dots 255] \cdot 0.1s$ "

This parameter is for setting the delay time for sending the output value to the bus. Options: **0..255**

Chapter 6 Description of Communication Object

The communication object is the medium to communicate other device on the bus, namely only the communication object can communicate with the bus.

NOTE: “C” in “Flag” column in the below table means enable the communication function of the object; “W” means value of object can be written from the bus; “R” means the value of the object can be read by the other devices; “T” means the object has the transmission function; “U” means the value of the object can be updated.

6.2. “General” Communication Object

Number	Name	Object Function	Descríp	Group Address	Length	C	R	W	T	U	Data Type	Priority
1	General	In operation			1 bit	C	R	-	T	-	switch	Low
204	Extension function	Night mode			1 bit	C	-	W	T	U	day/night	Low
208	Extension function	Panel orientation indication			1 bit	C	-	W	-	-	trigger	Low
206	Extension function	Proximity input			1 bit	C	-	W	-	-	switch	Low

Fig.6.1 “General” communication object

NO.	Object Function	Name	Data Type	Flag	DPT
1	In operation	General	1bit	C,R,T	1.001 switch
<p>The communication object is used to periodically send a telegram “1” to the bus to indicate that the device is working properly.</p>					
204	Night mode	Extension function	1bit	C,W C,W,T,U	1.024 day/night
<p>This communication object is used to send day/night status to the bus. Telegram value:</p> <p style="text-align: center;">0 --- Day</p> <p style="text-align: center;">1 --- Night</p> <p>The object flag is C,W when send read request is disabled; The object flag is C,W,T,U when it is enabled.</p>					
206	Proximity input	Extension function	1bit	C,W	1.001 switch
<p>The communication object is visible when proximity function is triggered by the object. Receive the telegram value from bus:</p> <p style="text-align: center;">1 --- Trigger proximity function</p> <p style="text-align: center;">0 --- Leaving (No proximity)</p>					

208	Panel orientation indication	Extension function	1bit	C,W	1.017 trigger
<p>This communication object is used to receive the telegrams from the bus that trigger panel orientation indication function. Telegram value is set by the parameter.</p>					

Table 6.1 "General" communication object table

6.3. "Internal sensor" Communication Object

Number	Name	Object Function	Descr	Group	Length	C	R	W	T	U	Data Type	Priority
2	Internal sensor	Temperature value			2 bytes	C	R	-	T	-	temperature (°C)	Low
3	Internal sensor	Low temperature alarm			1 bit	C	R	-	T	-	alarm	Low
4	Internal sensor	High temperature alarm			1 bit	C	R	-	T	-	alarm	Low

Fig.6.2 "Internal sensor" communication object

NO.	Object Function	Name	Data Type	Flag	DPT
2	Temperature value	Internal sensor	2byte	C,R,T	9.001 temperature
<p>The communication object is used for transmitting the temperature value detected by the built-in temperature sensor of the device to the bus. Range:-50~99.8°C</p>					
3	Low temperature alarm	Internal sensor	1bit	C,R,T	1.005 alarm
<p>The communication object is used to send the low temperature alarm signal to bus, when temperature lower than low threshold that defined by parameter.</p>					
4	High temperature alarm	Internal sensor	1bit	C,R,T	1.005 alarm
<p>The communication object is used to send the high temperature alarm signal to bus, when temperature higher than high threshold that defined by parameter.</p>					

Table 6.2 "Internal sensor" communication object table

6.4. "Input" Communication Object

Number	Name	Object Function	Descr	Group	Length	C	R	W	T	U	Data Type	Priority
198	Input 1 - Temperature probe	Actual temperature, Sensor			2 bytes	C	R	-	T	-	temperature (°C)	Low
199	Input 1 - Temperature probe	Temperature error report, Sensor			1 bit	C	R	-	T	-	alarm	Low

Temperature probe

Number	Name	Object Function	Descr	Group	Length	C	R	W	T	U	Data Type	Priority
198	Input 1 - Switch sensor	Switch			1 bit	C	-	W	T	U	switch	Low
198	Input 1 - Switch sensor	Close, Switch			1 bit	C	-	W	T	U	switch	Low
199	Input 1 - Switch sensor	Open, Switch			1 bit	C	-	W	T	U	switch	Low
198	Input 1 - Switch sensor	Short, Switch			1 bit	C	-	W	T	U	switch	Low
199	Input 1 - Switch sensor	Long, Switch			1 bit	C	-	W	T	U	switch	Low
200	Input 1 - Switch sensor	Disable			1 bit	C	-	W	-	-	enable	Low

BI: Switch sensor

Number	Name	Object Function	Descr	Group #	Length	C	R	W	T	U	Data Type	Priority
198	Input 1 - Scene control	Scene			1 byte	C	-	-	T	-	scene control	Low
198	Input 1 - Scene control	Close, Scene			1 byte	C	-	-	T	-	scene control	Low
199	Input 1 - Scene control	Open, Scene			1 byte	C	-	-	T	-	scene control	Low
198	Input 1 - Scene control	Short, Scene			1 byte	C	-	-	T	-	scene control	Low
199	Input 1 - Scene control	Long, Scene			1 byte	C	-	-	T	-	scene control	Low
200	Input 1 - Scene control	Disable			1 bit	C	-	W	-	-	enable	Low

BI: Scene control

Number	Name	Object Function	Descr	Group #	Length	C	R	W	T	U	Data Type	Priority
198	Input 1 - Send String	String			14 bytes	C	-	-	T	-	Character String (ISO...	Low
198	Input 1 - Send String	Close, String			14 bytes	C	-	-	T	-	Character String (ISO...	Low
199	Input 1 - Send String	Open, String			14 bytes	C	-	-	T	-	Character String (ISO...	Low
198	Input 1 - Send String	Short, String			14 bytes	C	-	-	T	-	Character String (ISO...	Low
199	Input 1 - Send String	Long, String			14 bytes	C	-	-	T	-	Character String (ISO...	Low

BI: Send string

Fig.6.3 "Input" communication object

NO.	Object Function	Name	Data Type	Flag	DPT
198	Actual temperature, Sensor	Input 1 - {{Temperature probe}}	2byte	C,R,T	9.001 temperature
<p>The communication object is used for transmitting the temperature value detected by the external temperature sensor of the device to the bus. Range:-50~99.8°C</p> <p>The name in parentheses changes with the parameter "Description (max 30 char.)". If description is empty, display "Input x - ..." by default. The same below.</p>					
199	Temperature error report, Sensor	Input 1 - {{Temperature probe}}	1bit	C,R,T	1.005 alarm
<p>The communication object is used to send the error report of the external temperature sensor, and the object value is defined according to the parameters.</p>					
198	Switch	Input 1 - {{Switch sensor}}	1bit	C,W,T,U	1.001 switch
198	Close/Short, Switch	Input 1 - {{Switch sensor}}	1bit	C,W,T,U	1.001 switch
199	Open/Long, Switch	Input 1 - {{Switch sensor}}	1bit	C,W,T,U	1.001 switch
<p>These communication objects are used to trigger a switching operation. Use a common object or two separate objects is according to the parameter setting.</p> <p>Only the object "Switch" is visible when use a common object. If use two separate objects, "Close/Open" is visible when there is no distinction for short/long operation; "Short/Long" is visible when there is distinction for short/long operation. Telegrams:</p> <p style="text-align: center;">0—Off</p> <p style="text-align: center;">1—On</p>					
198	Scene	Input 1 - {{Scene control}}	1byte	C,T	18.001 scene control

198	Close/Short, Scene	Input 1 - {{Scene control}}	1byte	C,T	18.001 scene control
199	Open/Long, Scene	Input 1 - {{Scene control}}	1byte	C,T	18.001 scene control

These communication objects are used to send a 8 bit command to recall or storage scene. Use a common object or two separate objects is according to the parameter setting.

Only the object "Scene" is visible when use a common object. If use two separate objects, "Close/Open" is visible when there is no distinction for short/long operation; "Short/Long" is visible when there is distinction for short/long operation. Telegrams:

Detailed 8bit the meaning of the directive.

Set up a 8bit Orders for the (Binary code): FXNNNNNN

F: '0' recall scene; '1' for storage scene;

X: 0;

NNNNNN: Scene number(0... 63).

As follows:

Object message value	Description
0	Recall scene 1
1	Recall scene 2
2	Recall scene 3
...	...
63	Recall scene 64
128	Store scene 1
129	Store scene 2
130	Store scene 3
...	...
191	Store scene 64

Parameter setting Options are 1~64, actually communication object "Scene" corresponds to the telegram received is 0~63 . Such as parameter settings is the scene 1, communication object "Scene" sends the scene for 0.

198	String	Input 1 - {{Send String}}	14byte	C,T	16.001 character string (ISO 8859-1)
198	Close/Short, String	Input 1 - {{Send String}}	14byte	C,T	16.001 character string (ISO 8859-1)
199	Open/Long, String	Input 1 - {{Send String}}	14byte	C,T	16.001 character string (ISO 8859-1)

These communication objects are used to send the string to bus. Use a common object or two separate objects is according to the parameter setting.

Only the object "String" is visible when use a common object. If use two separate objects, "Close/Open" is visible when there is no distinction for short/long operation; "Short/Long" is visible when there is distinction for short/long operation.

200	Disable	Input 1 - {...}	1bit	C,W	1.003 enable
------------	----------------	------------------------	-------------	------------	---------------------

The communication object is used to disable/enable the function of contact input, apply to binary input function, including switch, scene and send string.

Table 6.3 "Input" communication object table

6.5. "Button" Communication Object

Number	Name	Object Function	Descr	Group	Length	C	R	W	T	U	Data Type	Priority
142	Button 1 - Switching	Switch			1 bit	C	-	W	T	U	switch	Low
142	Button 1 - Switching	Press, Switch			1 bit	C	-	W	T	U	switch	Low
143	Button 1 - Switching	Release, Switch			1 bit	C	-	W	T	U	switch	Low
142	Button 1 - Switching	Short, Switch			1 bit	C	-	W	T	U	switch	Low
143	Button 1 - Switching	Long, Switch			1 bit	C	-	W	T	U	switch	Low
147	Button 1 - Switching	Disable			1 bit	C	-	W	-	-	enable	Low
148	Button 1 - Switching	LED status			1 bit	C	-	W	T	U	switch	Low

Switching

Number	Name	Object Function	Descr	Group	Length	C	R	W	T	U	Data Type	Priority
142	Button 1 - Dimming	Short, Switch			1 bit	C	-	W	T	U	switch	Low
143	Button 1 - Dimming	Long, Dimming			4 bit	C	-	W	T	-	dimming control	Low
147	Button 1 - Dimming	Disable			1 bit	C	-	W	-	-	enable	Low
148	Button 1 - Dimming	LED status			1 bit	C	-	W	T	U	switch	Low

Dimming

Number	Name	Object Function	Descr	Group	Length	C	R	W	T	U	Data Type	Priority
142	Button 1 - RGB	Switch			1 bit	C	-	W	T	U	switch	Low
143	Button 1 - RGB	RGB dimming value			3 bytes	C	-	-	T	-	RGB value 3x(0..255)	Low
143	Button 1 - RGB	Red dimming value			1 byte	C	-	-	T	-	percentage (0..100%)	Low
144	Button 1 - RGB	Green dimming value			1 byte	C	-	-	T	-	percentage (0..100%)	Low
145	Button 1 - RGB	Blue dimming value			1 byte	C	-	-	T	-	percentage (0..100%)	Low
147	Button 1 - RGB	Disable			1 bit	C	-	W	-	-	enable	Low
148	Button 1 - RGB	LED status			1 bit	C	-	W	T	U	switch	Low

RGB lighting

Number	Name	Object Function	Descr	Group	Length	C	R	W	T	U	Data Type	Priority
142	Button 1 - RGBW	Switch			1 bit	C	-	W	T	U	switch	Low
143	Button 1 - RGBW	RGBW dimming value			6 bytes	C	-	-	T	-	RGBW value 4x(0..100%)	Low
143	Button 1 - RGBW	Red dimming value			1 byte	C	-	-	T	-	percentage (0..100%)	Low
144	Button 1 - RGBW	Green dimming value			1 byte	C	-	-	T	-	percentage (0..100%)	Low
145	Button 1 - RGBW	Blue dimming value			1 byte	C	-	-	T	-	percentage (0..100%)	Low
146	Button 1 - RGBW	White dimming value			1 byte	C	-	-	T	-	percentage (0..100%)	Low
147	Button 1 - RGBW	Disable			1 bit	C	-	W	-	-	enable	Low
148	Button 1 - RGBW	LED status			1 bit	C	-	W	T	U	switch	Low

RGBW lighting

Number	Name	Object Function	Descr	Group	Length	C	R	W	T	U	Data Type	Priority
142	Button 1 - Colour temperature	Switch			1 bit	C	-	W	T	U	switch	Low
143	Button 1 - Colour temperature	Brightness value			1 byte	C	-	-	T	-	percentage (0..100%)	Low
144	Button 1 - Colour temperature	Colour temperature value			2 bytes	C	-	-	T	-	absolute colour temperature (K)	Low
147	Button 1 - Colour temperature	Disable			1 bit	C	-	W	-	-	enable	Low
148	Button 1 - Colour temperature	LED status			1 bit	C	-	W	T	U	switch	Low

Colour temperature control

Number	Name	Object Function	Descr	Group	Length	C	R	W	T	U	Data Type	Priority
142	Button 1 - Value sender	Short, 1bit value			1 bit	C	-	-	T	-	switch	Low
143	Button 1 - Value sender	Long, 1bit value			1 bit	C	-	-	T	-	switch	Low
142	Button 1 - Value sender	Short, 2bit value			2 bit	C	-	-	T	-	switch control	Low
143	Button 1 - Value sender	Long, 2bit value			2 bit	C	-	-	T	-	switch control	Low
142	Button 1 - Value sender	Short, 4bit value			4 bit	C	-	-	T	-	dimming control	Low
143	Button 1 - Value sender	Long, 4bit value			4 bit	C	-	-	T	-	dimming control	Low
142	Button 1 - Value sender	Short, 1byte value			1 byte	C	-	-	T	-	counter pulses (0..255)	Low
143	Button 1 - Value sender	Long, 1byte value			1 byte	C	-	-	T	-	counter pulses (0..255)	Low
142	Button 1 - Value sender	Short, 2byte value			2 bytes	C	-	-	T	-	pulses	Low
143	Button 1 - Value sender	Long, 2byte value			2 bytes	C	-	-	T	-	pulses	Low
142	Button 1 - Value sender	Short, 2byte float value			2 bytes	C	-	-	T	-	2-byte float value	Low
143	Button 1 - Value sender	Long, 2byte float value			2 bytes	C	-	-	T	-	2-byte float value	Low

Value sender(1)

142	Button 1 - Value sender	Short, 4byte value			4 bytes	C	-	-	T	-	counter pulses (unsig...	Low
143	Button 1 - Value sender	Long, 4byte value			4 bytes	C	-	-	T	-	counter pulses (unsig...	Low
142	Button 1 - Value sender	Short, 4byte float value			4 bytes	C	-	-	T	-	4-byte float value	Low
143	Button 1 - Value sender	Long, 4byte float value			4 bytes	C	-	-	T	-	4-byte float value	Low

Value sender(2)

Number	Name	Object Function	Descr	Group	Length	C	R	W	T	U	Data Type	Priority
142	Button 1 - Scene	Scene			1 byte	C	-	-	T	-	scene control	Low
142	Button 1 - Scene	Short, Scene			1 byte	C	-	-	T	-	scene control	Low
143	Button 1 - Scene	Long, Scene			1 byte	C	-	-	T	-	scene control	Low
147	Button 1 - Scene	Disable			1 bit	C	-	W	-	-	enable	Low
148	Button 1 - Scene	LED status			1 bit	C	-	W	T	U	switch	Low

Scene

Number	Name	Object Function	Description	Group Address	Length	C	R	W	T	U	Data Type	Priority
142	Button 1 - Blind	Up/Down, Blind			1 bit	C	-	W	T	-	up/down	Low
143	Button 1 - Blind	Stop/Adjust, Blind			1 bit	C	-	W	T	-	step	Low
147	Button 1 - Blind	Disable			1 bit	C	-	W	-	-	enable	Low
148	Button 1 - Blind	LED status			1 bit	C	-	W	T	U	switch	Low

Blind

Number	Name	Object Function	Descr	Group	Length	C	R	W	T	U	Data Type	Priority
142	Button 1 - Shift register	Register value			1 byte	C	-	W	T	-	counter pulses (0..255)	Low
968	Btn 1 - Shift register	Disable			1 bit	C	-	W	-	-	enable	Low
969	Btn 1 - Shift register	LED status			1 bit	C	-	W	T	U	switch	Low

Shift register

Number	Name	Object Function	Descr	Group	Length	C	R	W	T	U	Data Type	Priority
142	Button 1 - Multiple operation	Object1-On/Off			1 bit	C	-	W	T	-	switch	Low
142	Button 1 - Multiple operation	Object1-Up/Down			1 bit	C	-	W	T	-	up/down	Low
142	Button 1 - Multiple operation	Object1-SceneControl			1 byte	C	-	-	T	-	scene control	Low
142	Button 1 - Multiple operation	Object1-Percentage			1 byte	C	-	-	T	-	percentage (0..100%)	Low
142	Button 1 - Multiple operation	Object1-Unsigned value			1 byte	C	-	-	T	-	counter pulses (0..255)	Low
147	Button 1 - Multiple operation	Disable			1 bit	C	-	W	-	-	enable	Low
148	Button 1 - Multiple operation	LED status			1 bit	C	-	W	T	U	switch	Low

Multiple operation

Number	Name	Object Function	Descr	Group	Length	C	R	W	T	U	Data Type	Priority
142	Button 1 - Delay mode	Short, Delay mode			1 bit	C	-	-	T	-	switch	Low
143	Button 1 - Delay mode	Long, Delay mode			1 bit	C	-	-	T	-	switch	Low
142	Button 1 - Delay mode	Short, Delay mode			4 bit	C	-	-	T	-	dimming control	Low
143	Button 1 - Delay mode	Long, Delay mode			4 bit	C	-	-	T	-	dimming control	Low
142	Button 1 - Delay mode	Short, Delay mode			1 byte	C	-	-	T	-	counter pulses (0..255)	Low
143	Button 1 - Delay mode	Long, Delay mode			1 byte	C	-	-	T	-	counter pulses (0..255)	Low
147	Button 1 - Delay mode	Disable			1 bit	C	-	W	-	-	enable	Low
148	Button 1 - Delay mode	LED status			1 bit	C	-	W	T	U	switch	Low

Delay mode

Number	Name	Object Function	Descr	Group	Length	C	R	W	T	U	Data Type	Priority
142	Button 1 - RTC mode	Comfort mode			1 bit	C	-	-	T	-	enable	Low
143	Button 1 - RTC mode	Economy mode			1 bit	C	-	-	T	-	enable	Low
144	Button 1 - RTC mode	Frost/Heat protection mode			1 bit	C	-	-	T	-	enable	Low
145	Button 1 - RTC mode	Standby mode			1 bit	C	-	-	T	-	enable	Low
142	Button 1 - RTC mode	Operation mode			1 byte	C	-	-	T	-	HVAC mode	Low
147	Button 1 - RTC mode	Disable			1 bit	C	-	W	-	-	enable	Low
148	Button 1 - RTC mode	LED status			1 bit	C	-	W	T	U	switch	Low

RTC operation mode

Number	Name	Object Function	Descr	Group	Length	C	R	W	T	U	Data Type	Priority
142	Button 1 - String	String			14 bytes	C	-	-	T	-	Character String (ISO 8859-1)	Low
147	Button 1 - String	Disable			1 bit	C	-	W	-	-	enable	Low
148	Button 1 - String	LED status			1 bit	C	-	W	T	U	switch	Low

String(14bytes)
Fig.6.4 "Button" communication object

NO.	Object Function	Name	Data Type	Flag	DPT
142	Switch	Button 1 - {{Switching}}	1bit	C,W,T,U	1.001 switch
142	Press/Short, Switch	Button 1 - {{Switching}}	1bit	C,W,T,U	1.001 switch
143	Release/Long, Switch	Button 1 - {{Switching}}	1bit	C,W,T,U	1.001 switch

These communication objects are used to trigger a switching operation. Use a common object or two separate objects is according to the parameter setting when press/release and long/short operation.

Only the object "Switch" is visible when use a common object. If use two separate objects, "Press/Release" is visible when there is no distinction for short/long operation; "Short/Long" is visible when there is distinction for short/long operation. Telegrams:

0—Off

1—On

The name in parentheses changes with the parameter "Description (max 30char.)". If description is empty, display "Btn 1 - ..." by default. The same below.

142	Short, Switch	Button 1 - {{Dimming}}	1bit	C,W,T,U	1.001 switch
143	Long, Dimming	Button 1 - {{Dimming}}	4bit	C,W,T	3.007 dimming

These two communication objects are used to switch/dimming operation, with distinction for long/short operation.

Obj.142: Used to trigger switch operation. Telegrams:

0—Off

1—On

Obj.143: Used to trigger a relative dimming operation.

Dimming down when telegram is 1~7, and the larger this range the adjust step is smaller. That is, the maximum step of dimming down when is 1, and the minimum step of dimming down when is 7, stop dimming when is 0;

Dimming up when telegram is 9~15, and the larger this range the adjust step is smaller. That is, the maximum step of dimming up when is 9, and the minimum step of dimming up when is 15, stop dimming when is 8.

142	Switch	Button 1 - {{RGB}}	1bit	C,W,T,U	1.001 switch
143	RGB dimming value	Button 1 - {{RGB}}	3byte	C,T	232.600 RGB value 3x(0..255)
143	Red dimming value	Button 1 - {{RGB}}	1byte	C,T	5.001 percentage(0..100%)
144	Green dimming value	Button 1 - {{RGB}}	1byte	C,T	5.001 percentage(0..100%)
145	Blue dimming value	Button 1 - {{RGB}}	1byte	C,T	5.001 percentage(0..100%)

Obj.142: Used to trigger switch operation. Telegrams:

0—Off

1—On

Obj.143: The communication object is visible when 1x3byte for the RGB object type is selected.

Apply to control brightness of multi-colour lamp, used for sending brightness value of RGB three-colour lamp to the bus.

3-Byte Code for RGB Dimming Object Data Type: U8 U8 U8, as follows:

3 _{MSB}	2	1 _{LSB}
R	G	B
UUUUUUUU	UUUUUUUU	UUUUUUUU

R: red dimming value; G: green dimming value; B: blue dimming value.

Obj.143, Obj.144, Obj.145: These three communication objects are visible when 3x1byte for the RGB object type is selected. Apply to control brightness of multi-colour lamp, used for sending brightness value of the control R(red) /G(green) / B (blue) channel to the bus. Telegrams: 0...100%

142	Switch	Button 1 - {{RGBW}}	1bit	C,W,T,U	1.001 switch
-----	--------	---------------------	------	---------	--------------

143	RGBW dimming value	Button 1 - {{RGBW}}	6byte	C,T	251.600 DPT_Colour_RGBW
143	Red dimming value	Button 1 - {{RGBW}}	1byte	C,T	5.001 percentage(0..100%)
144	Green dimming value	Button 1 - {{RGBW}}	1byte	C,T	5.001 percentage(0..100%)
145	Blue dimming value	Button 1 - {{RGBW}}	1byte	C,T	5.001 percentage(0..100%)
146	White dimming value	Button 1 - {{RGBW}}	1byte	C,T	5.001 percentage(0..100%)

Obj.142: Used to trigger switch operation. Telegrams:

0—Off

1—On

Obj.143: The communication object is visible when 1x6byte for the RGBW object type is selected.

Apply to control brightness of multi-colour lamp, used for sending brightness value of RGBW four-colour lamp to the bus.

6 _{MSB}	5	4	3	2	1 _{LSB}
R	G	B	W	Reserve	r r r r mR mG mB mW
UUUUUUUU	UUUUUUUU	UUUUUUUU	UUUUUUUU	0000000	0000BBBB
				0	

R: red dimming value; G: green dimming value; B: blue dimming value; W: white dimming value;

mR: determines whether the red dimming value is valid, 0 = invalid, 1 = valid;

mG: determines whether the green dimming value is valid, 0 = invalid, 1 = valid;

mB: determines whether the blue dimming value is valid, 0 = invalid, 1 = valid;

mW: Determines whether the white dimming value is valid, 0 = invalid, 1 = valid.

Obj.143, Obj.144, Obj.145, Obj.146: These four communication objects are visible when 4x1byte for the RGBW object type is selected. Apply to control brightness of multi-colour lamp, used for sending brightness value of the control R(red) /G(green) / B (blue) / W(White) channel to the bus. Telegrams: 0...100%

142	Switch	Button 1 - {{Colour temperature}}	1bit	C,W,T,U	1.001 switch
143	Brightness value	Button 1 - {{Colour temperature}}	1byte	C,T	5.001 percentage(0..100%)
144	Colour temperature value	Button 1 - {{Colour temperature}}	2byte	C,T	7.600 absolute colour temperature
<p>Obj.142: Used to trigger switch operation. Telegrams:</p> <p style="padding-left: 40px;">0—Off</p> <p style="padding-left: 40px;">1—On</p> <p>Obj.143: Used for sending the dimming telegram of the colour temperature to the bus, that is, sending the brightness value. Telegrams: 0...100%</p> <p>Obj.144: Used for sending the control telegram of the colour temperature to the bus.</p> <p>Telegrams: 1000...10000 K</p>					
142	Short, 1bit value Short, 2bit value Short, 4bit value Short, 1byte value Short, 2byte value Short, 2byte float value Short, 4byte value Short, 4byte float value	Button 1 - {{Value sender}}	1bit 2bit 4bit 1byte 2byte	C,T	1.001 switch 2.001 switch control 3.007 dimming 5.010 counter pulses 7.001 pulses 9.x float value 12.001 counter pulses 14.x float value
143	Long, 1bit value Long, 2bit value Long, 4bit value Long, 1byte value Long, 2byte value Short, 2byte float value Short, 4byte value Short, 4byte float value	Button 1 - {{Value sender}}	1bit 2bit 4bit 1byte 2byte	C,T	1.001 switch 2.001 switch control 3.007 dimming 5.010 counter pulses 7.001 pulses 9.x float value 12.001 counter pulses 14.x float value

These two communication objects are used for sending a fixed value to the bus, distinguish long and short operation. Range of values that can be sent are determined by the datatype, and the datatype is determined by the parameter setting.

142	Scene	Button 1 - {{Scene}}	1byte	C,T	18.001 scene control
142	Short, Scene	Button 1 - {{Scene}}	1byte	C,T	18.001 scene control
143	Long, Scene	Button 1 - {{Scene}}	1byte	C,T	18.001 scene control

These communication objects are used to send a 8 bit command to recall or storage scene. Use a common object or two separate objects is according to the parameter setting when long and short operation.

Only the object "Scene" is visible when use a common object. If use two separate objects, "Short/Long" is visible when there is distinction for short/long operation. Telegrams:

Detailed 8bit the meaning of the directive.

Set up a 8bit Orders for the (Binary code): FXNNNNNN

F: '0' recall scene; '1' for storage scene;

X : 0 ;

NNNNNN: Scene number(0... 63).

As follows:

Object message value	Description
0	Recall scene 1
1	Recall scene 2
2	Recall scene 3
...	...
63	Recall scene 64
128	Store scene 1
129	Store scene 2
130	Store scene 3
...	...
191	Store scene 64

Parameter setting Options are 1~64, actually communication object "Scene" corresponds to the telegram received is 0~63 . Such as parameter settings is the scene 1, communication object "Scene" sends the scene for 0.

142	Up/Down, Blind	Btn 1 - {{Blind}}	1bit	C,W,T	1.008 up/down
143	Stop/Adjust, Blind	Btn 1 - {{Blind}}	1bit	C,W,T	1.007 step
<p>This two communication objects are used to control the blind up,down, stop:</p> <p>Obj.142: Used for sending the telegram to the bus, to control blind up/down. Telegrams:</p> <p style="padding-left: 40px;">1—Move down</p> <p style="padding-left: 40px;">0—Move up</p> <p>Obj.143: Used for sending the telegram to the bus, to stop curtain movement. Telegrams:</p> <p style="padding-left: 40px;">1—Stop</p>					
142	Register value	Button 1 - {{Shift register}}	1byte	C,W,T	5.010 counter pulses
<p>The communication object is used to send the value of shift register.</p>					
142	Object1-On/Off Object1-Up/Down Object1-SceneControl Object1-Percentage Object1-Unsigned value	Button 1 - {{Multiple operation}}	1bit 1bit 1byte 1byte 1byte	C,W,T C,W,T C,T C,T C,T	1.001 switch 1.008 up/down 18.001 scene control 5.001 percentage(0..100%) 5.010 counter pulses
<p>The communication object is object of multiple operation, up to activate 4 objects at the same time, and operation once can send the value of 4 different datatype objects to the bus via these objects. Range of values that can be sent are determined by the datatype, and the datatype is determined by the parameter setting.</p>					
142	Short, Delay mode	Button 1 - {{Delay mode}}	1bit 4bit 1byte	C,T	1.001 switch 3.007 dimming 5.010 counter pulses
143	Long, Delay mode	Button 1 - {{Delay mode}}	1bit 4bit 1byte	C,T	1.001 switch 3.007 dimming 5.010 counter pulses
<p>These communication objects are used to send the value of delay mode to the bus, distinguish long and short operation. Range of values that can be sent are determined by the datatype, and the datatype is determined by the parameter setting.</p>					

142	Operation mode	Button 1 - {{RTC mode}}	1byte	C,T	20.102 HVAC mode
142	Comfort mode	Button 1 - {{RTC mode}}	1bit	C,T	1.003 enable
143	Economy mode	Button 1 - {{RTC mode}}	1bit	C,T	1.003 enable
144	Frost/Heat protection mode	Button 1 - {{RTC mode}}	1bit	C,T	1.003 enable
145	Standby mode	Button 1 - {{RTC mode}}	1bit	C,T	1.003 enable
<p>These communication objects are used to send the RTC operation mode status to the bus.</p> <p>When 1 byte: object 142 is visible, telegrams: 1-Comfort, 2-Standby, 3-Economy, 4-Protection, other reserved.</p> <p>When 1bit:</p> <p style="padding-left: 40px;">Object 142—Comfort mode</p> <p style="padding-left: 40px;">Object 143—Economy mode</p> <p style="padding-left: 40px;">Object 144—Protection mode</p> <p style="padding-left: 40px;">Object 145—Standby mode</p> <p>Only corresponding object send telegram “1” when activate one mode. When 1 bit standby object is not enable, three objects comfort, economy, protection all send 0 to activate standby mode. When 1 bit standby object is enable, only standby object sends 1 to activate standby mode.</p>					
142	String	Button 1 - {{String}}	14byte	C,T	16.001 character string (ISO 8859-1)
<p>The communication object is used to send the string to the bus.</p>					
147	Disable	Button 1 - {...}	1bit	C,W	1.003 enable
<p>The communication object is used to disable/enable the function of contact input, apply to all the above functions.</p>					
148	LED status	Button 1 - {...}	1bit 1byte	C,W,T,U	1.001 switch 5.010 counter pulses
<p>The communication object is used to control LED status via the bus, and also can receive status feedback. Range of values that can be sent are determined by the datatype, and the datatype is determined by the parameter setting.</p>					

Table 6.4 “Button” communication object table

6.6. “Logic” Communication Object

6.6.1. “AND/OR/XOR” Communication Object

Number	Name	Object Function	Descr	Group #	Length	C	R	W	T	U	Data Type	Priority
5	1st Logic	Input a			1 bit	C	-	W	T	U	boolean	Low
6	1st Logic	Input b			1 bit	C	-	W	T	U	boolean	Low
7	1st Logic	Input c			1 bit	C	-	W	T	U	boolean	Low
8	1st Logic	Input d			1 bit	C	-	W	T	U	boolean	Low
9	1st Logic	Input e			1 bit	C	-	W	T	U	boolean	Low
10	1st Logic	Input f			1 bit	C	-	W	T	U	boolean	Low
11	1st Logic	Input g			1 bit	C	-	W	T	U	boolean	Low
12	1st Logic	Input h			1 bit	C	-	W	T	U	boolean	Low
13	1st Logic	Logic result			1 bit	C	-	-	T	-	boolean	Low

Fig.6.5.1 “AND/OR/XOR” communication object

NO.	Object Function	Name	Data Type	Flag	DPT
5/...	Input x	{{1st Logic}}	1bit	C,W,T,U	1.002 boolean
<p>The communication object is used to receive the value of logical input Input x.</p> <p>The name in parentheses changes with the parameter “Description for logic function”. If description is empty, display “1st Logic” by default. The same below.</p>					
13	Logic result	{{1st Logic}}	1bit	C,T	1.002 boolean
<p>The communication object is used to send the results of logical operation.</p>					

Table 6.5.1 “AND/OR/XOR” communication object table

6.6.2. “Gate forwarding” Communication Object

Number	Name	Object Function	Descr	Group #	Length	C	R	W	T	U	Data Type	Priority
5	1st Logic	Gate value select			1 byte	C	-	W	-	-	scene number	Low
6	1st Logic	Input A			1 bit	C	-	W	-	-	switch	Low
7	1st Logic	Input B			1 bit	C	-	W	-	-	switch	Low
8	1st Logic	Input C			1 bit	C	-	W	-	-	switch	Low
9	1st Logic	Input D			1 bit	C	-	W	-	-	switch	Low
10	1st Logic	Output A			1 bit	C	-	-	T	-	switch	Low
11	1st Logic	Output B			1 bit	C	-	-	T	-	switch	Low
12	1st Logic	Output C			1 bit	C	-	-	T	-	switch	Low
13	1st Logic	Output D			1 bit	C	-	-	T	-	switch	Low

Fig.6.5.2 “Gate forwarding” communication object

NO.	Object Function	Name	Data Type	Flag	DPT
5	Gate value select	{{1st Logic}}	1byte	C,W	17.001 scene number
<p>The communication object is used to select the scene of logical gate forwarding.</p>					
6/.../9	Input x	{{1st Logic}}	1bit 4bit 1byte	C,W	1.001 switch 3.007 dimming control 5.010 counter pulses(0..255)

The communication object is used to receive the value of the logic gate input Input x.					
10../13	Output x	{{1st Logic}}	1bit 4bit 1byte	C,T	1.001 switch 3.007 dimming control 5.010 counter pulses(0..255)
The communication object is used to output the value forwarded by the logic gate. The output value is the same as the input value, but one input can be forwarded into one or more outputs, set by parameters.					

Table 6.5.2 "Gate forwarding" communication object table

6.6.3. "Threshold comparator" Communication Object

Number	Name	Object Function	Descr	Group	Length	C	R	W	T	U	Data Type	Priority
5	1st Logic	Threshold value input			4 bit	C	-	W	-	U	dimming control	Low
5	1st Logic	Threshold value input			1 byte	C	-	W	-	U	counter pulses (0..255)	Low
5	1st Logic	Threshold value input			2 bytes	C	-	W	-	U	pulses	Low
5	1st Logic	Threshold value input			2 bytes	C	-	W	-	U	2-byte signed value	Low
5	1st Logic	Threshold value input			2 bytes	C	-	W	-	U	2-byte float value	Low
5	1st Logic	Threshold value input			4 bytes	C	-	W	-	U	counter pulses (unsigned)	Low
5	1st Logic	Threshold value input			2 bytes	C	-	W	-	U	temperature (°C)	Low
5	1st Logic	Threshold value input			2 bytes	C	-	W	-	U	lux (Lux)	Low
13	1st Logic	Logic result			1 bit	C	-	-	T	-	boolean	Low

Fig.6.5.3 "Threshold comparator" communication object

NO.	Object Function	Name	Data Type	Flag	DPT
5	Threshold value input	{{1st Logic}}	4bit 1byte 2byte 4byte	C,W, U	3.007 dimming 5.010 counter pulses 7.001 pulses 12.001 counter pulses 8.x signed value 9.x float value 9.001 temperature 9.007 humidity 9.004 lux
The communication object is used to input threshold value.					
13	Logic result	{{1st Logic}}	1bit	C,T	1.002 boolean
The communication object is used to send the results of logical operation. That is, the value that should be sent after the object input threshold is compared with the setting threshold value.					

Table 6.5.3 "Threshold comparator" communication object table

6.6.4. "Format convert" Communication Object

Number	Name	Object Function	Descr	Group A	Length	C	R	W	T	U	Data Type	Priority
5	1st Logic	Input 1bit-bit0			1 bit	C	-	W	-	U	boolean	Low
6	1st Logic	Input 1bit-bit1			1 bit	C	-	W	-	U	boolean	Low
13	1st Logic	Output 2bit			2 bit	C	-	-	T	-	switch control	Low

"2x1bit -> 1x2bit"function: converts two 1bit values to a 2bit value, such as Input bit1=1, bit0=0-> Output 2bit=2

Number	Name	Object Function	Descr	Group A	Length	C	R	W	T	U	Data Type	Priority
5	1st Logic	Input 1bit-bit0			1 bit	C	-	W	-	U	boolean	Low
6	1st Logic	Input 1bit-bit1			1 bit	C	-	W	-	U	boolean	Low
7	1st Logic	Input 1bit-bit2			1 bit	C	-	W	-	U	boolean	Low
8	1st Logic	Input 1bit-bit3			1 bit	C	-	W	-	U	boolean	Low
9	1st Logic	Input 1bit-bit4			1 bit	C	-	W	-	U	boolean	Low
10	1st Logic	Input 1bit-bit5			1 bit	C	-	W	-	U	boolean	Low
11	1st Logic	Input 1bit-bit6			1 bit	C	-	W	-	U	boolean	Low
12	1st Logic	Input 1bit-bit7			1 bit	C	-	W	-	U	boolean	Low
13	1st Logic	Output 1byte			1 byte	C	-	-	T	-	counter pulses (0..255)	Low

"8x1bit -> 1x1byte"function: converts eight 1bit values to a 1byte value, such as Input bit2=1, bit1=1, bit0=1, other bits are 0-> Output 1byte=7

Number	Name	Object Function	Descr	Group A	Length	C	R	W	T	U	Data Type	Priority
5	1st Logic	Input 1byte			1 byte	C	-	W	-	U	counter pulses (0..255)	Low
13	1st Logic	Output 2byte			2 bytes	C	-	-	T	-	pulses	Low

"1x1byte -> 1x2byte"function: converts one 1byte values to a 2byte value, such as Input 1byte=125-> Output 2byte=125. Although the value remains the same, the data type of the value is different.

Number	Name	Object Function	Descr	Group A	Length	C	R	W	T	U	Data Type	Priority
5	1st Logic	Input 1byte			1 byte	C	-	W	-	U	counter pulses (0..255)	Low
13	1st Logic	Output 2byte			2 bytes	C	-	-	T	-	pulses	Low

"2x1byte -> 1x2byte"function: converts two 1byte values to a 2byte value, such as Input 1byte-low = 255 (\$FF), Input 1byte-high = 100 (\$64) -> Output 2byte = 25855 (\$64 FF)

Number	Name	Object Function	Descr	Group A	Length	C	R	W	T	U	Data Type	Priority
5	1st Logic	Input 2byte-low			2 bytes	C	-	W	-	U	pulses	Low
6	1st Logic	Input 2byte-high			2 bytes	C	-	W	-	U	pulses	Low
13	1st Logic	Output 4byte			4 bytes	C	-	-	T	-	counter pulses (unsigned)	Low

"2x2byte -> 1x4byte"function: converts two 2 byte values to a 4byte value, such as Input 2byte-low = 65530 (\$FF FA), Input 2byte-high = 32768 (\$80 00)-> Output 2byte = 2147549178 (\$80 00 FF FA)

Number	Name	Object Function	Descr	Group A	Length	C	R	W	T	U	Data Type	Priority
5	1st Logic	Input 1byte			1 byte	C	-	W	-	U	counter pulses (0..255)	Low
6	1st Logic	Output 1bit-bit0			1 bit	C	-	-	T	-	boolean	Low
7	1st Logic	Output 1bit-bit1			1 bit	C	-	-	T	-	boolean	Low
8	1st Logic	Output 1bit-bit2			1 bit	C	-	-	T	-	boolean	Low
9	1st Logic	Output 1bit-bit3			1 bit	C	-	-	T	-	boolean	Low
10	1st Logic	Output 1bit-bit4			1 bit	C	-	-	T	-	boolean	Low
11	1st Logic	Output 1bit-bit5			1 bit	C	-	-	T	-	boolean	Low
12	1st Logic	Output 1bit-bit6			1 bit	C	-	-	T	-	boolean	Low
13	1st Logic	Output 1bit-bit7			1 bit	C	-	-	T	-	boolean	Low

“1x1byte -> 8x1bit” function: converts one 1byte values to eight 1bit value, such as Input 1byte=200 -> Output bit0=0, bit1=0, bit2=0, bit3=1, bit4=0, bit5=0, bit6=1, bit7=1

Number	Name	Object Function	Descr	Group A	Length	C	R	W	T	U	Data Type	Priority
5	1st Logic	Input 2byte			2 bytes	C	-	W	-	U	pulses	Low
12	1st Logic	Output 1byte-low			1 byte	C	-	-	T	-	counter pulses (0..255)	Low
13	1st Logic	Output 1byte-high			1 byte	C	-	-	T	-	counter pulses (0..255)	Low

“1x2byte -> 2x1byte”function: converts one 2byte values to two 1byte value, such as Input 2byte = 55500 (\$D8 CC) -> Output 1byte-low = 204 (\$CC), Output 1byte-high =216 (\$D8)

Number	Name	Object Function	Descr	Group A	Length	C	R	W	T	U	Data Type	Priority
5	1st Logic	Input 4byte			4 bytes	C	-	W	-	U	counter pulses (unsigned)	Low
12	1st Logic	Output 2byte-low			2 bytes	C	-	-	T	-	pulses	Low
13	1st Logic	Output 2byte-high			2 bytes	C	-	-	T	-	pulses	Low

“1x4byte -> 2x2byte”function: converts one 4byte values to two 2byte value, such as Input 4byte = 78009500 (\$04 A6 54 9C) -> Output 2byte-low = 21660 (\$54 9C), Output 2byte-high =1190 (\$04 A6)

Number	Name	Object Function	Descr	Group A	Length	C	R	W	T	U	Data Type	Priority
5	1st Logic	Input 3byte			3 bytes	C	-	W	-	U	RGB value 3x(0..255)	Low
11	1st Logic	Output 1byte-low			1 byte	C	-	-	T	-	counter pulses (0..255)	Low
12	1st Logic	Output 1byte-middle			1 byte	C	-	-	T	-	counter pulses (0..255)	Low
13	1st Logic	Output 1byte-high			1 byte	C	-	-	T	-	counter pulses (0..255)	Low

“1x3byte -> 3x1byte”function: converts one 3byte values to three 1byte value, such as Input 3byte = \$78 64 C8-> Output 1byte-low = 200 (\$C8) , Output 1byte-middle = 100 (\$64) , Output 1byte-high =120 (\$78)

Number	Name	Object Function	Descr	Group A	Length	C	R	W	T	U	Data Type	Priority
5	1st Logic	Input 1byte-low			1 byte	C	-	W	-	U	counter pulses (0..255)	Low
6	1st Logic	Input 1byte-middle			1 byte	C	-	W	-	U	counter pulses (0..255)	Low
7	1st Logic	Input 1byte-high			1 byte	C	-	W	-	U	counter pulses (0..255)	Low
13	1st Logic	Output 3byte			3 bytes	C	-	-	T	-	RGB value 3x(0..255)	Low

“3x1byte -> 1x3byte”function: converts three 1byte values to a 3byte value, such as Input 1byte-low = 150 (\$96), Input 1byte-middle = 100 (\$64), Input 1byte-high = 50 (\$32)-> Output 3byte = \$32 64 96

Fig.6.5.4 “Format convert” communication object

NO.	Object Function	Name	Data Type	Flag	DPT
5	Input ...	{{1st Logic}}	1bit	C,W,U	1.001 switch
			1byte		5.010 counter pulses(0..255)
			2byte		7.001 pulses
			3byte		232.600 RGB value 3x(0..255)
			4byte		12.001 counter pulses
The communication object is used to input a value that needs to be converted.					
13	Output ...	{{1st Logic}}	1bit	C,T	1.001 switch
			2bit		2.001 switch control
			1byte		5.010 counter pulses(0..255)
			2byte		7.001 pulses
			3byte		232.600 RGB value 3x(0..255)
4byte	12.001 counter pulses				
The communication object is used to output the converted value.					

Table 6.5.4 "Format convert" communication object table

6.6.5. "Gate function" Communication Object

Number	Name	Object Function	Descr	Group	Length	C	R	W	T	U	Data Type	Priority
5	1st Logic	Input			1 bit	C	-	W	-	-	switch	Low
6	1st Logic	Gate input			1 bit	C	-	W	-	-	boolean	Low
13	1st Logic	Output			1 bit	C	-	-	T	-	switch	Low
Input/Output - 1bit[On/Off]												
Number	Name	Object Function	Descr	Group	Length	C	R	W	T	U	Data Type	Priority
5	1st Logic	Input			1 byte	C	-	W	-	-	percentage (0..100%)	Low
6	1st Logic	Gate input			1 bit	C	-	W	-	-	boolean	Low
13	1st Logic	Output			1 byte	C	-	-	T	-	percentage (0..100%)	Low
Input/Output - 1byte[0..100%]												
Number	Name	Object Function	Descr	Group	Length	C	R	W	T	U	Data Type	Priority
5	1st Logic	Input			1 byte	C	-	W	-	-	counter pulses (0..255)	Low
6	1st Logic	Gate input			1 bit	C	-	W	-	-	boolean	Low
13	1st Logic	Output			1 byte	C	-	-	T	-	counter pulses (0..255)	Low
Input/Output - 1byte[0..255]												
Number	Name	Object Function	Descr	Group	Length	C	R	W	T	U	Data Type	Priority
5	1st Logic	Input			2 bytes	C	-	W	-	-	temperature (°C)	Low
6	1st Logic	Gate input			1 bit	C	-	W	-	-	boolean	Low
13	1st Logic	Output			2 bytes	C	-	-	T	-	temperature (°C)	Low
Input/Output - 2byte[Float]												
Number	Name	Object Function	Descr	Group	Length	C	R	W	T	U	Data Type	Priority
5	1st Logic	Input			2 bytes	C	-	W	-	-	pulses	Low
6	1st Logic	Gate input			1 bit	C	-	W	-	-	boolean	Low
13	1st Logic	Output			2 bytes	C	-	-	T	-	pulses	Low
Input/Output - 2byte[0..65535]												

Fig.6.5.5 "Gate function" communication object

NO.	Object Function	Name	Data Type	Flag	DPT
5	Input	{{1st Logic}}	1bit	C,W	1.001 switch
			1byte		5.001 percentage
			2byte		5.010 counter pulses
					9.001 temperature
					7.001 pulses
The communication object is used to input a value that needs to gate filter.					
6	Gate input	{{1st Logic}}	1bit	C,W	1.002 boolean
The communication object is used to control the switch status of gate input. Input signal is allowed to pass when gate open, then output, and the current input status is still sent if there is a change; Can not pass when gate close.					
13	Output	{{1st Logic}}	bit	C,T	1.001 switch
			1byte		5.001 percentage
			2byte		5.010 counter pulses
					9.001 temperature
					7.001 pulses
The communication object is used to output the value after gate filtering. Only when gate input status is open, output is available, defined by the object "Gate input".					

Table 6.5.5 "Gate function" communication object table

6.6.6. "Delay function" Communication Object

Number	Name	Object Function	Descr	Group	Length	C	R	W	T	U	Data Type	Priority
5	1st Logic	Input			1 bit	C	-	W	-	-	switch	Low
13	1st Logic	Output			1 bit	C	-	-	T	-	switch	Low
Input/Output - 1bit[On/Off]												
5	1st Logic	Input			1 byte	C	-	W	-	-	percentage (0..100%)	Low
13	1st Logic	Output			1 byte	C	-	-	T	-	percentage (0..100%)	Low
Input/Output - 1byte[0..100%]												
5	1st Logic	Input			1 byte	C	-	W	-	-	counter pulses (0..255)	Low
13	1st Logic	Output			1 byte	C	-	-	T	-	counter pulses (0..255)	Low
Input/Output - 1byte[0..255]												
5	1st Logic	Input			2 bytes	C	-	W	-	-	temperature (°C)	Low
13	1st Logic	Output			2 bytes	C	-	-	T	-	temperature (°C)	Low
Input/Output - 2byte[Float]												
5	1st Logic	Input			2 bytes	C	-	W	-	-	pulses	Low
13	1st Logic	Output			2 bytes	C	-	-	T	-	pulses	Low
Input/Output - 2byte[0..65535]												

Fig.6.5.6 "Delay function" communication object

NO.	Object Function	Name	Data Type	Flag	DPT
5	Input	{{1st Logic}}	1bit 1byte 2byte	C,W	1.001 switch 5.001 percentage 5.010 counter pulses 9.001 temperature 7.001 pulses
The communication object is used to input a value that needs to delay.					
13	Output	{{1st Logic}}	1bit 1byte 2byte	C,T	1.001 switch 5.001 percentage 5.010 counter pulses 9.001 temperature 7.001 pulses
The communication object is used to output that needs to delay converted value, delay time is defined by the parameter.					

Table 6.5.6 "Delay function" communication object table

6.6.7. "Staircase lighting" Communication Object

Number	Name	Object Function	Descr	Group	Length	C	R	W	T	U	Data Type	Priority
5	1st Logic	Trigger value			1 bit	C	-	W	-	-	trigger	Low
6	1st Logic	Light-on duration time			2 bytes	C	-	W	-	-	time (s)	Low
13	1st Logic	Output			1 bit	C	-	-	T	-	switch	Low
13	1st Logic	Output			1 byte	C	-	-	T	-	counter pulses (0..255)	Low

Fig.6.5.7 "Staircase lighting" communication object

NO.	Object Function	Name	Data Type	Flag	DPT
5	Trigger value	{{1st Logic}}	1bit	C,W	1.017 trigger
The communication object is used to receive the value to trigger staircase lighting.					
6	Light-on duration time	{{1st Logic}}	2byte	C,W	7.005 time(s)
The communication object is used to modify the staircase light-on duration time, the modified range is referenced from the range defined by the parameter, take the limit value if exceeded.					
13	Output	{{1st Logic}}	1bit 1byte	C,T	1.001 switch 5.010 counter pulses
The communication object is used to output value 1 when trigger, and send value 2 after duration time. Telegram value is determined by the parameter setting datatype.					

Table 6.5.7 "Staircase lighting" communication object table

6.7. “Scene Group” Communication Object

Number	Name	Object Function	Description	Group Address	Length	C	R	W	T	U	Data Type	Priority
77	Scene Group	Main scene trigger			1 byte	C	-	W	-	-	scene num...	Low
78	1st Scene Group-Output 1	1bit value			1 bit	C	-	-	T	-	switch	Low
79	1st Scene Group-Output 2	1bit value			1 bit	C	-	-	T	-	switch	Low
80	1st Scene Group-Output 3	1bit value			1 bit	C	-	-	T	-	switch	Low
81	1st Scene Group-Output 4	1bit value			1 bit	C	-	-	T	-	switch	Low
82	1st Scene Group-Output 5	1bit value			1 bit	C	-	-	T	-	switch	Low
83	1st Scene Group-Output 6	1bit value			1 bit	C	-	-	T	-	switch	Low
84	1st Scene Group-Output 7	1bit value			1 bit	C	-	-	T	-	switch	Low
85	1st Scene Group-Output 8	1bit value			1 bit	C	-	-	T	-	switch	Low

Fig.6.6 “Scene Group” communication object

NO.	Object Function	Name	Data Type	Flag	DPT
77	Main scene trigger	Scene Group	1byte	C,W	17.001 scene number
<p>This communication object triggers each output in the scene group to send a specific value to the bus by recalling the scene number. Telegrams: 0.. 63</p>					
78/..	1bit value 1byte unsigned value HVAC mode 2byte unsigned value Temperature	1st Scene Group-{{Output x}}	1bit 1byte 2byte	C,T	1.001 switch 5.010 counter pulses 20.102 HVAC mode 7.001 pulses 9.001 temperature
<p>When a scene is recalled, the communication object is used to send the corresponding output value of the scene to the bus. If the output is not set to this scene, it will not be sent.</p> <p>A total of 8 scene groups can be set up, with 8 outputs per group.</p> <p>The name in parentheses changes with the parameter “Description for logic function”. If description is empty, display “1st Scene Group-Output x” by default. The same below.</p>					

Table 6.6 “Scene Group” communication object table