

User Manual

K-BUS® Multifunctional Actuator with Secure, 4/8/16/24-Fold_V1.0

AMMA-04/06.S

AMMA-08/10.S

AMMA-16/10.S

AMMA-24/10.S

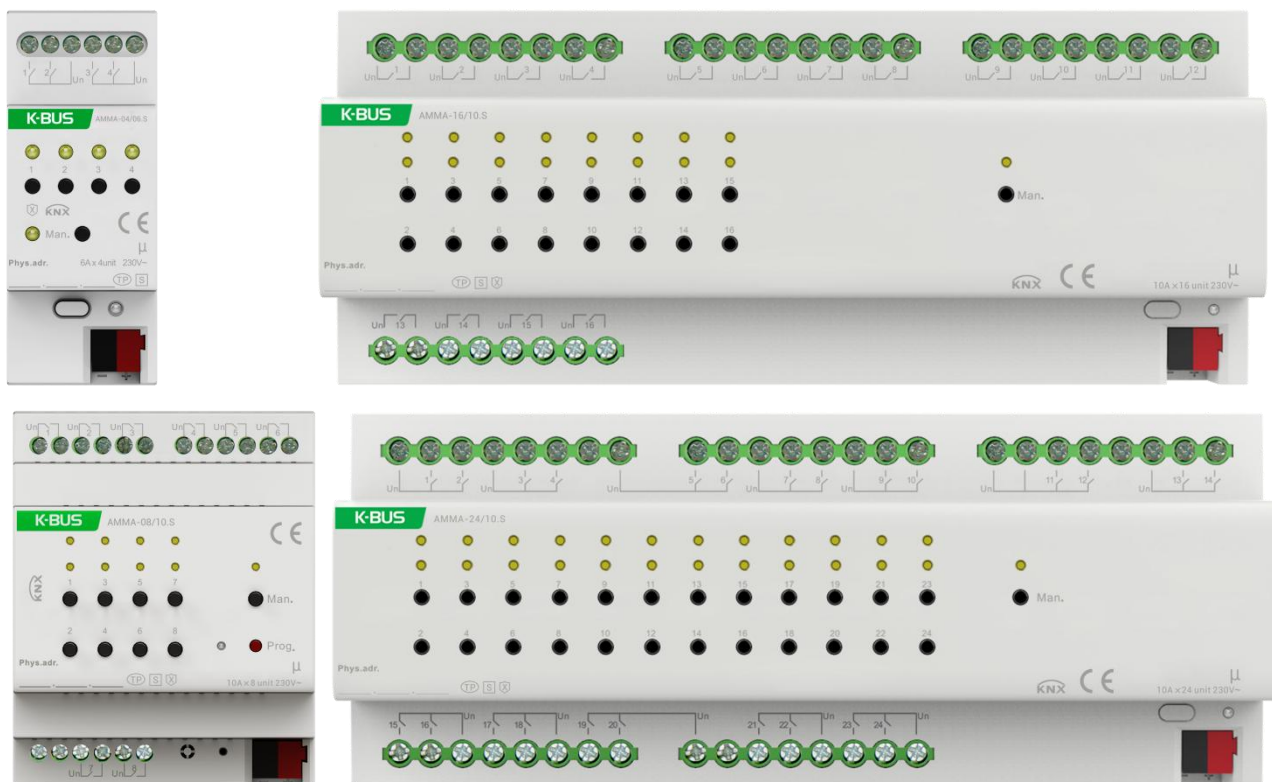

KNX/EIB Home and Building Control System

Attentions

1. Please keep devices away from strong magnetic field, high temperature, wet environment;



2. Do not fall the device to the ground or make them get hard impact;



3. Do not use wet cloth or volatile reagent to wipe the device;



4. Do not disassemble the devices.

Contents

Chapter 1 General	1
Chapter 2 Technical Data	5
2.1. AMMA-04/06.S	5
2.2. AMMA-08/10.S	7
2.3. AMMA-16/10.S	9
2.4. AMMA-24/10.S	11
Chapter 3 Dimension and Connection Diagram	13
3.1. Dimension diagram	13
3.2. Connection diagram	15
3.2.1. AMMA-04/06.S	15
3.2.2. AMMA-08/10.S	16
3.2.3. AMMA-16/10.S	17
3.2.4. AMMA-24/10.S	18
Chapter 4 Parameter setting description in the ETS	21
4.1. KNX Secure	21
4.2. Parameter window "General"	25
4.3. Parameter window "Channel function"	28
4.4. Switch outputs-- Switch actuator	31
4.4.1. Parameter window "Switch actuator: Output X"	31
4.4.2. Parameter window "Ox: Time"	35
4.4.3. Parameter window "Ox: Logic"	40
4.4.4. Parameter window "Ox: Scene"	43
4.4.5. Parameter window "Ox: Forced"	44
4.4.6. Parameter window "Ox: Operation hours counter"	46
4.4.7. Explanation of priority	47
4.5. Switch outputs-- Heating actuator(without controller)	48
4.5.1. Explanation of priority	54
4.6. Shutter (AC) outputs	55
4.6.1. Parameter window "Curtain X: Venetian Blind"	55
4.6.2. Parameter "Curtain X: Shutter"	72
4.6.3. Explanation of priority	73
4.7. Shutter (DC) outputs	74
4.8. Fan coil outputs	75
4.8.1. Parameter window "Fan type -- One level"	75
4.8.2. Parameter window "Fan type -- Multi-level"	85
4.8.3. Explanation of priority	101
4.9. Valve Control	102
4.9.1. Parameter window "Vx: Heating/Cooling"	106
4.9.2. Explanation of priority	119
Chapter 5 Communication Object Description	121
5.1. Communication object of General	121
5.2. Communication object of switch output	122
5.2.1. Communication object of switch actuator	122
5.2.2. Communication object of heating actuator(without controller)	125

5.3. Communication object of curtain (AC/DC) output -----	127
5.4. Communication object of fan control -----	131
5.5. Communication object of valve output -----	134

Chapter 1 General

Multifunctional Actuator with Secure is a multi-output module, integrating multiple output functions, including switch output, curtain DC/AC output, fan output and valve output. You can configure the functions of the module according to your requirement, such as a part of the output for controlling the switch, a part of the output for controlling the curtain, and a part of the output for controlling the fan.

With 4, 8, 16 and 24 outputs for selection, the output of different output channels is different. For details, please refer to the technical chapter. One relay in the device represents one output, and some functions may require multiple outputs. For example, one curtain AC output needs to occupy two relay outputs, one relay is used to control Positive rotation, and one is used to control reverse rotation, and the common switch The output needs to occupy one relay output. Therefore, in the engineering application process, the product is selected according to actual needs. And with manual operation buttons on the top of the product, it is more convenient to cope with engineering debugging.

Multifunctional Actuator with Secure is a modular mounting device. For easy installation in the distribution box, it can be mounted on a 35 mm D-rail according to EN 60 715. The device is screwed to the electrical connection and the bus connection is directly connected via KNX Terminal connections, system power supply does not require an additional supply voltage other than the bus.

This manual provides detailed technical information about Multifunctional Actuator with Secure for users as well as assembly and programming details, and explains how to use the device by the application examples.

The function of the Multifunctional Actuator is summarized as follows:

--**Switch output**, which can connect some electrical loads, such as lighting, sockets and heating control. There are 24 outputs, one output occupies one relay control, and each output has electronic switch control.

The module offers the following functions:

- ◆ **Switch**
- ◆ **Time function: on/off delay**
- ◆ **Time function: flashing switch, for lamps of aging test**
- ◆ **Time function: staircase lighting, for switch on the staircase lighting and after the duration time the lighting can be turned off automatically. It is better if the function is used together with motion detector.**
- ◆ **Provide 8 scenes, recall and storing via a 1byte object**
- ◆ **Logic operation: AND, OR, XOR, GATE function, up to three logic inputs**
- ◆ **Status response, for know the current output state in the visualization**
- ◆ **Forced operation, two data types: 1bit/2bit, for force action on or off, with the highest priority**
- ◆ **Heating valve control**
- ◆ **Set the relay contact position after bus voltage recovery**
- ◆ **Set the relay contact position after bus voltage failure**
- ◆ **Manual switch outputs**

—**Shutter AC/DC output**, which can connect with motor blinds, awnings, roller blinds, vertical blind, etc. There are 12 outputs with 230V AC 370W (4/8-Fold) or 1000W(16/24-Fold) motor or dry contact controlling motor or 6-channel DC control mode (DC motor control type). The output contacts for the directions UP and DOWN. The pause on change in direction can be set via the parameters. The curtains AC and DC are wired differently. The curtain AC occupies two relays per channel, and the curtain DC occupies four relays per channel. For the specific wiring method, please refer to the connection diagram in the third chapter, but their functions are similar.

The specific functions are summarized as follows:

- ◆ **Movement UP/DOWN**
- ◆ **Stop/Louvre adjustment**
- ◆ **Move to position 0...100%**

-
- ◆ **Adjustment Louvre to position 0...100%(only “Venetian Blind” working mode)**
 - ◆ **Set 8 scenes, store or recall via a 1byte object**
 - ◆ **Automatic sun protection**
 - ◆ **Safety function**
 - ◆ **Status response, query and reply the current shutter/blind position and operation mode to the bus, thereby indicating the status in the visualization device**
 - ◆ **Two working mode :Venetian Blind and Shutter**

—**Fan Drive Control**, can be connected to a single-phase fan, supports up to 3 levels of fan speed adjustment, the output contacts are the same as the switch output.

The function is summarized as follows:

- ◆ **Support the fan with 1-2-3 level fan speed**
- ◆ **The fan has two operating modes: step switch and steering switch**
- ◆ **Forced operation: The fan speed is only allowed within the allowed fan speed range, with the highest priority**
- ◆ **Automatic operation: Automatically run the fan speed according to the control value. The control value is obtained by the sensing device on the bus, and the minimum running time of the fan speed can be set.**
- ◆ **Normal operation: manually control the operation of the fan, such as through the operation panel, etc.**
- ◆ **Fan with multi-level fan speed can set start-up characteristics**
- ◆ **Single-level fan speed fan can set on/off delay or minimum running time**
- ◆ **Status feedback, such as automatic operation status, fan switching status, fan speed, etc.**
- ◆ **Operational control of bus power-up or power-down behavior**

—**Valve control**, can be used to connect 2 control or 4 control coil system, cooling valve and heating valve respectively use separate relay output, there are three types of control: continuous (3 point, open and close), PWM switch (continuous, PWM) and 2-point switch type (2 state-ON/OFF).

The continuous type controls the opening of the valve according to the control value of the valve. It can completely open or close the valve, and can also stop the valve in an intermediate position. This type of control is suitable for driving three-wire valves.

The PWM switch type can only make the valve fully open or completely closed. The valve is cyclically operated according to the control value (1byte) and PWM cycle. The valve switch is divided into normally open or normally closed. This control type is suitable for driving two-wire system. Valve.

The 2-point switch type is similar to the PWM switch type, and can only be fully opened or completely closed. The difference is that it is directly turned on or off according to the control value (1 bit) on the bus. It is usually suitable for the case where the switch valve is controlled according to the temperature difference. And suitable for driving two-wire valves.

The function is summarized as follows:

- ◆ **Supports three valve control types**
- ◆ **Monitor the control values on the bus to send fault status**
- ◆ **Valve characteristic curve correction (only for continuous valves)**
- ◆ **Automatic valve adjustment (for continuous valves only)**
- ◆ **Prohibit/enable heating or refrigerating valves**
- ◆ **Valve position status feedback or query**
- ◆ **Manual or automatic cleaning of the valve, sending the cleaning status**

Programmers are able to use the Engineering Tool Software ETS (ETS5 version or above) with knxprod file to allocate the physical address and set the parameters.

To make sure that all the programmable functions are used correctly, you must check the connection of the loads before use and note technical characteristic of loading equipment, particularly shutter driver, they refer more technical characteristics, some characteristics are inherent, if not properly set them, it is likely to cause the load device damage or not operating correctly.

Chapter 2 Technical Data

2.1. AMMA-04/06.S

Power Supply	Bus voltage	21~30V DC, via the KNX bus
	Bus current	<9mA/24V, <8mA/30V
	Bus consumption	<240mW
	Charging current	<20mA
Connection	KNX	Via bus connection terminals, Ø 0.8 mm
	Outputs	Screw terminals Wire Range 0.2-2.5mm ² , Torque 0.4N-m
Operation/Display	Programming LED and button	For assignment of the physical address
	Green LED flashing	Indicate the application layer running normally
	Manual operation button	Switch output
	Output LED	Indicating output status
	Manual / Auto. button	Switch manual/automatic mode
	Manual / Auto. LED	Indicates manual/auto mode status
Protection	IP 20, EN 60 529	
Temperature range	Operation	-5°C...+45°C
	Storage	-25°C...+55°C
	Transport	-25°C...+70°C
Environment	Humidity	<93%, except dewing
Design	Modular installation device (MDRC)	
	Housing/color	Plastic, beige
	Installation	On 35mm DIN-Rail, To EN 60 715
	Dimension	36 × 90 × 64mm
	Weight	0.20kg

Output	Max. 4-Fold Switch Outputs / 2-Fold Shutter AC Outputs / 1-Fold Shutter DC Outputs / 1-Fold Fan Coil Outputs / 1-Fold Valve Outputs, each Output can be configured separately	
	U _n Rated Voltage	230V AC (50/60Hz)
	I _n Rated Current	6A
	Inrush current	192A/1.2ms
Output life	Mechanical life	> 1 x 10 ⁶
	Electrical life (Resistive load)	> 5 x 10 ⁴

Load type	Rated power	Life cycles
Incandescent lamp	1380W	>20000
Halogen lamp	1380W	>5000
Standard ballast	1380W	>6000
Electronic ballast	1150W	>6000
Motor	600W	>20000
LED (Inrush current 260A/120us)	450W	>30000

Note: For the relay parameters, the above load is only for a single lamp. When multiple lamps are connected in parallel, the load can be reduced. Although the power is constant, the instantaneous inrush current will increase, which will easily melt the relay contacts. Therefore, in normal use, based on the measured current, the measured maximum inrush current must be within the allowable range.

Application program	Max. number of communication objects	Max. number of group addresses	Max. number of associations	Secure group addresses
Multifunctional Actuator with Secure, 4-Fold/3.0	92	1000	1000	200

2.2. AMMA-08/10.S

Power Supply	Bus voltage	21~30V DC, via the KNX bus
	Bus current	<10mA/24V, <9mA/30V
	Bus consumption	<270mW
	Charging current	<22mA
Connection	KNX	Via bus connection terminals, Ø 0.8 mm
	Outputs	Screw terminals Wire Range 0.2-2.5mm ² , Torque 0.4N-m
Operation/Display	Programming LED and button	For assignment of the physical address
	Green LED flashing	Indicate the application layer running normally
	Manual operation button	Switch output
	Output LED	Indicating output status
	Manual / Auto. button	Switch manual/automatic mode
	Manual / Auto. LED	Indicates manual/auto mode status
Protection	IP 20, EN 60 529	
Temperature range	Operation	-5°C...+45°C
	Storage	-25°C...+55°C
	Transport	-25°C...+70°C
Environment	Humidity	<93%, except dewing
Design	Modular installation device (MDRC)	
	Housing/color	Plastic, beige
	Installation	On 35mm DIN-Rail, To EN 60 715
	Dimension	72 × 90 × 64mm
	Weight	0.30kg

Output	Max. 8-Fold Switch Outputs / 4-Fold Shutter AC Outputs / 2-Fold Shutter DC Outputs / 2-Fold Fan Coil Outputs / 2-Fold Valve Outputs, each Output can be configured separately	
	U _n Rated Voltage	230V AC (50/60Hz)
	I _n Rated Current	10A
	Inrush current	192A/1.2ms
Output life	Mechanical life	> 1 x 10 ⁶
	Electrical life (Resistive load)	> 5 x 10 ⁴

Load type	Rated power	Life cycles
Incandescent lamp	2300W	>20000
Halogen lamp	2300W	>5000
Standard ballast	1840W	>6000
Electronic ballast	1150W	>6000
Motor	600W	>20000
LED (Inrush current 260A/120us)	450W	>30000

Note: For the relay parameters, the above load is only for a single lamp. When multiple lamps are connected in parallel, the load can be reduced. Although the power is constant, the instantaneous inrush current will increase, which will easily melt the relay contacts. Therefore, in normal use, based on the measured current, the measured maximum inrush current must be within the allowable range.

Application program	Max. number of communication objects	Max. number of group addresses	Max. number of associations	Secure group addresses
Multifunctional Actuator with Secure, 8-Fold/3.0	180	1000	1000	300

2.3. AMMA-16/10.S

Power Supply	Bus voltage	21~30V DC, via the KNX bus
	Bus current	<10mA/24V, <9mA/30V
	Bus consumption	<270mW
	Charging current	<24mA
Connection	KNX	Via bus connection terminals, Ø 0.8 mm
	Outputs	Screw terminals Wire Range 0.2-6.0mm ² , Torque 0.8N-m
Operation/Display	Programming LED and button	For assignment of the physical address
	Green LED flashing	Indicate the application layer running normally
	Manual operation button	Switch output
	Output LED	Indicating output status
	Manual / Auto. button	Switch manual/automatic mode
	Manual / Auto. LED	Indicates manual/auto mode status
Protection	IP 20, EN 60 529	
Temperature range	Operation	-5°C...+45°C
	Storage	-25°C...+55°C
	Transport	-25°C...+70°C
Environment	Humidity	<93%, except dewing
Design	Modular installation device (MDRC)	
	Housing/color	Plastic, beige
	Installation	On 35mm DIN-Rail, To EN 60 715
	Dimension	216 × 90 × 64mm
	Weight	0.70kg
Output	Max. 16-Fold Switch Outputs / 8-Fold Shutter AC Outputs / 4-Fold Shutter DC Outputs / 4-Fold Fan Coil Outputs / 4-Fold Valve Outputs, each Output can be configured separately	

	U _n Rated Voltage	230V AC (50/60Hz)
	I _n Rated Current	10A
	Inrush current	300A/2ms
Output life	Mechanical life	> 1 x 10 ⁶
	Electrical life (Resistive load)	> 10 ⁵

Load type	Rated power	Life cycles
Incandescent lamp	2300W	>30000
Halogen lamp	2300W	>5000
Standard ballast	2300W	>5000
Electronic ballast	2000W	>5000
Fluorescent lamp (uncompensated)	2300W	>5000
Fluorescent lamp (parallel compensated)	2000W	>5000
Motor	1000W	>6000
LED (Inrush current 260A/120us)	450W	>30000

Note: For the relay parameters, the above load is only for a single lamp. When multiple lamps are connected in parallel, the load can be reduced. Although the power is constant, the instantaneous inrush current will increase, which will easily melt the relay contacts. Therefore, in normal use, based on the measured current, the measured maximum inrush current must be within the allowable range.

Application program	Max. number of communication objects	Max. number of group addresses	Max. number of associations	Secure group addresses
Multifunctional Actuator with Secure, 16-Fold/3.0	356	1000	1000	500

2.4. AMMA-24/10.S

Power Supply	Bus voltage	21~30V DC, via the KNX bus
	Bus current	<12mA/24V, <11mA/30V
	Bus consumption	<330mW
	Charging current	<28mA
Connection	KNX	Via bus connection terminals, Ø 0.8 mm
	Outputs	Screw terminals Wire Range 0.2-6.0mm ² , Torque 0.8N-m
Operation/Display	Programming LED and button	For assignment of the physical address
	Green LED flashing	Indicate the application layer running normally
	Manual operation button	Switch output
	Output LED	Indicating output status
	Manual / Auto. button	Switch manual/automatic mode
	Manual / Auto. LED	Indicates manual/auto mode status
Protection	IP 20, EN 60 529	
Temperature range	Operation	-5°C...+45°C
	Storage	-25°C...+55°C
	Transport	-25°C...+70°C
Environment	Humidity	<93%, except dewing
Design	Modular installation device (MDRC)	
	Housing/color	Plastic, beige
	Installation	On 35mm DIN-Rail, To EN 60 715
	Dimension	216 × 90 × 64mm
	Weight	0.85kg
Output	Max. 24-Fold Switch Outputs / 12-Fold Shutter AC Outputs / 6-Fold Shutter DC Outputs / 6-Fold Fan Coil Outputs / 6-Fold Valve Outputs, each Output can be configured separately	

	U _n Rated Voltage	230V AC (50/60Hz)
	I _n Rated Current	10A
	Inrush current	300A/2ms
Output life	Mechanical life	> 1 x 10 ⁶
	Electrical life (Resistive load)	> 10 ⁵

Load type	Rated power	Life cycles
Incandescent lamp	2300W	>30000
Halogen lamp	2300W	>5000
Standard ballast	2300W	>5000
Electronic ballast	2000W	>5000
Fluorescent lamp (uncompensated)	2300W	>5000
Fluorescent lamp (parallel compensated)	2000W	>5000
Motor	1000W	>6000
LED (Inrush current 260A/120us)	450W	>30000

Note: For the relay parameters, the above load is only for a single lamp. When multiple lamps are connected in parallel, the load can be reduced. Although the power is constant, the instantaneous inrush current will increase, which will easily melt the relay contacts. Therefore, in normal use, based on the measured current, the measured maximum inrush current must be within the allowable range.

Application program	Max. number of communication objects	Max. number of group addresses	Max. number of associations	Secure group addresses
Multifunctional Actuator with Secure, 24-Fold/3.0	532	1000	1000	700

Chapter 3 Dimension and Connection Diagram

3.1. Dimension diagram

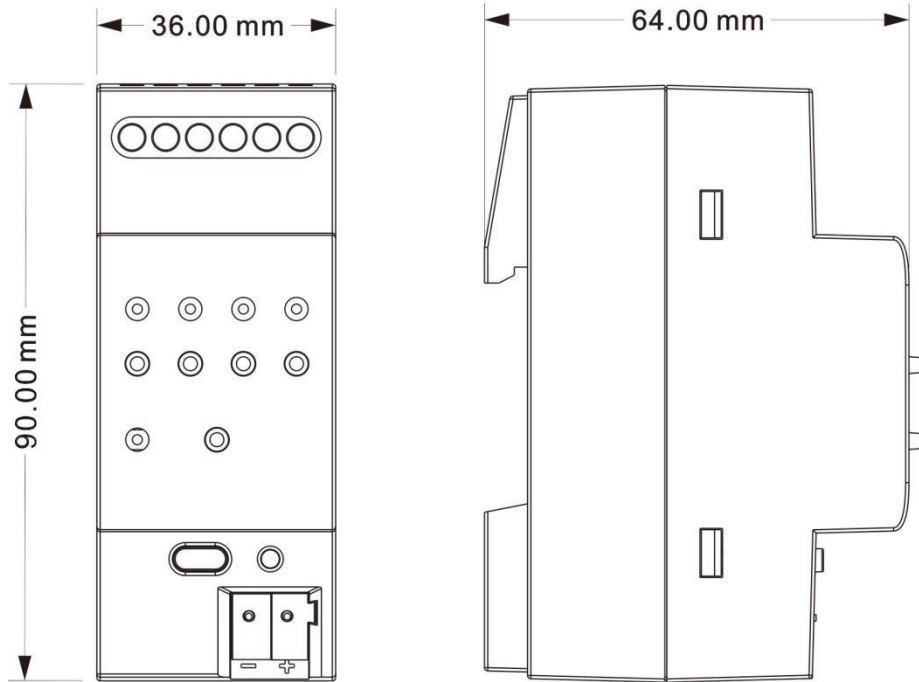

AMMA-04/06.S

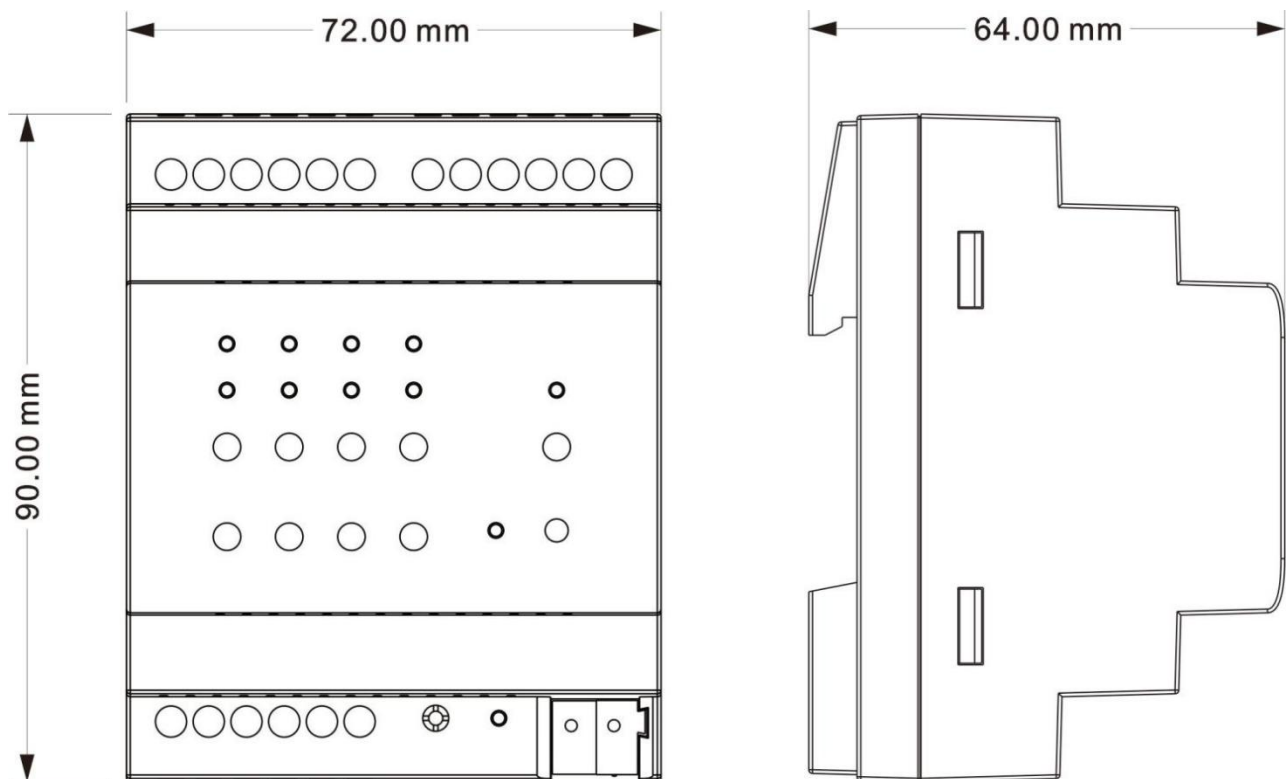

AMMA-08/10.S

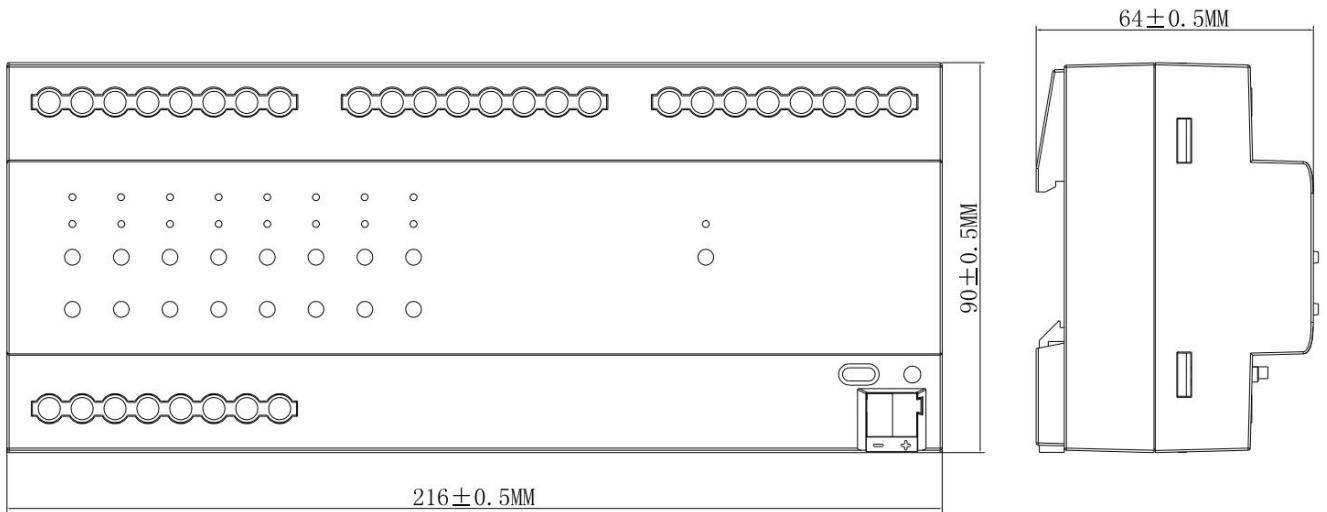

AMMA-16/10.S

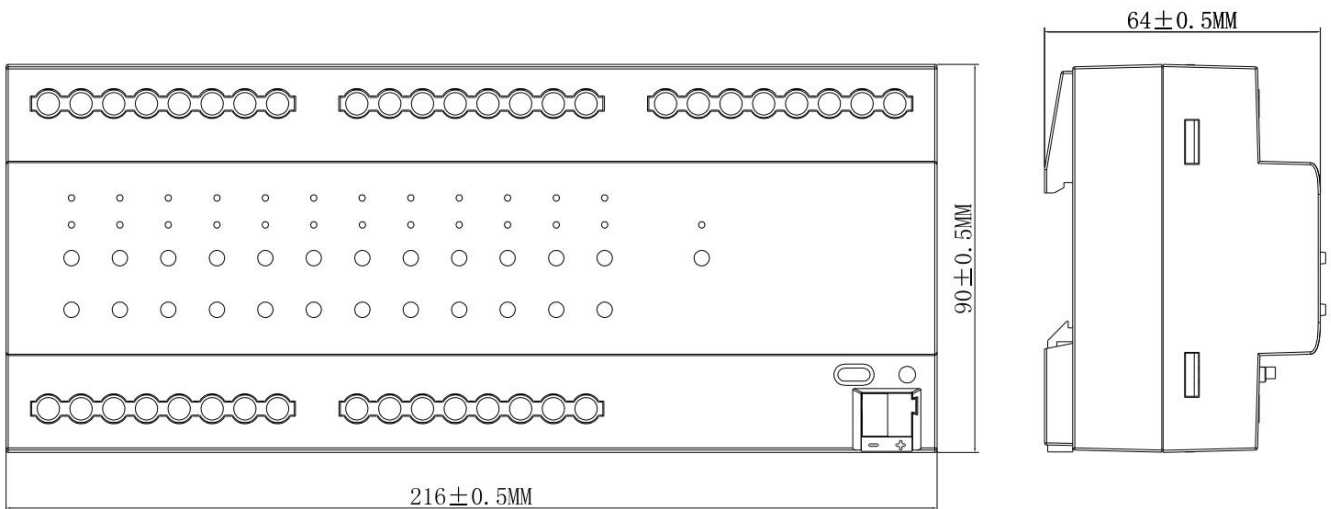

AMMA-24/10.S

3.2. Connection diagram

3.2.1. AMMA-04/06.S

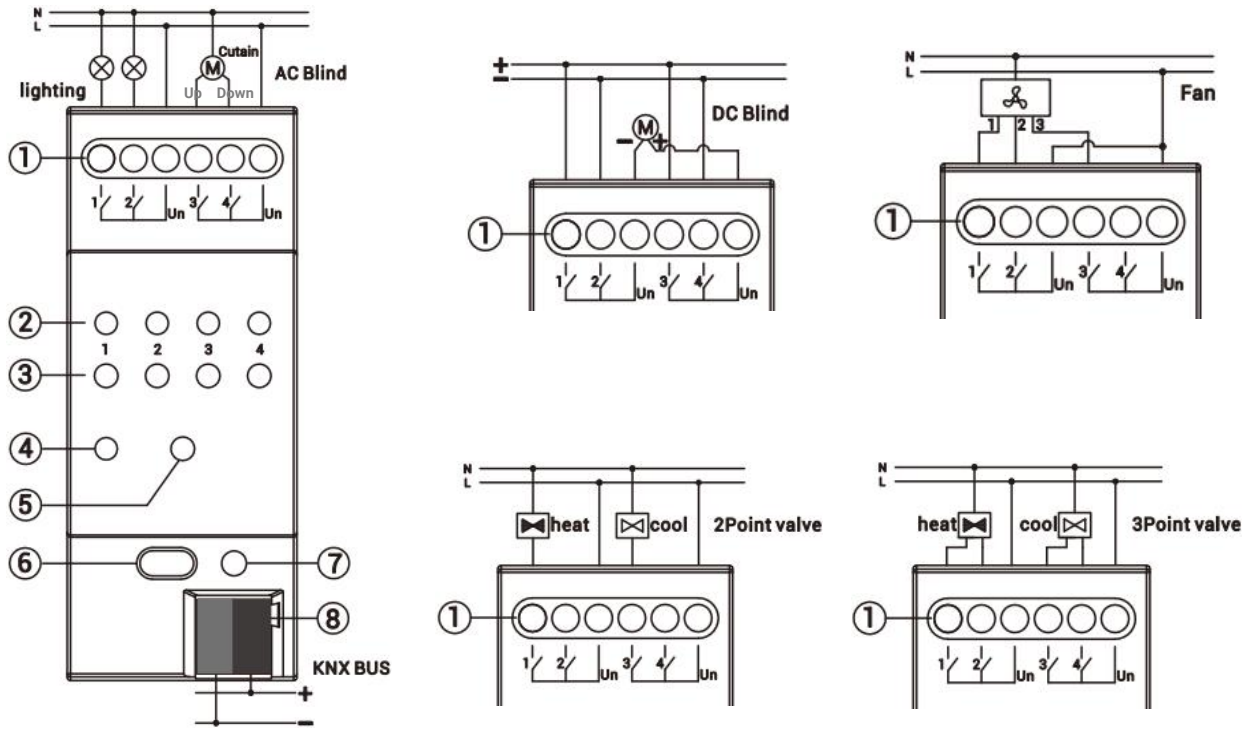

3.2.2. AMMA-08/10.S

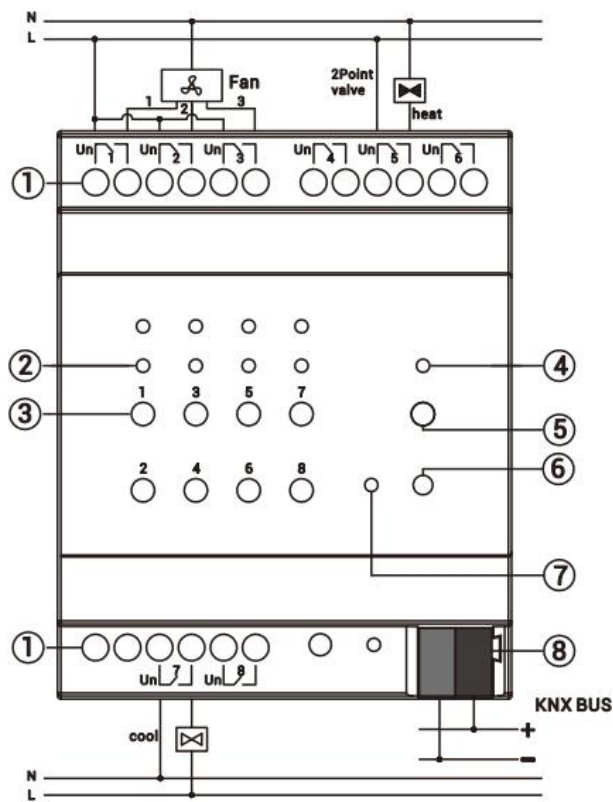
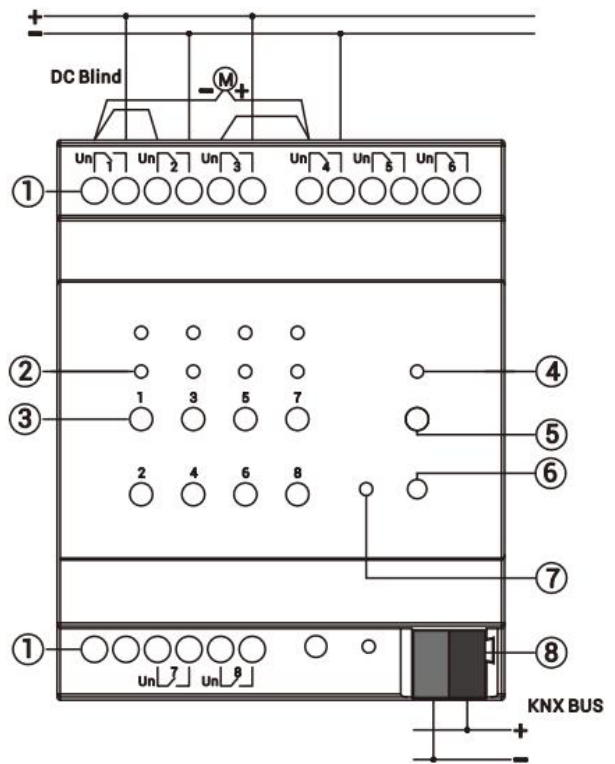
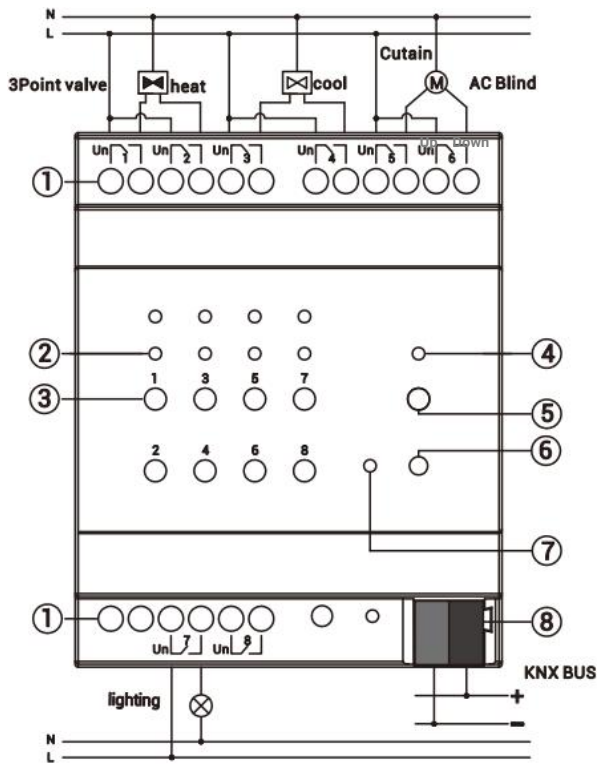

3.2.3. AMMA-16/10.S

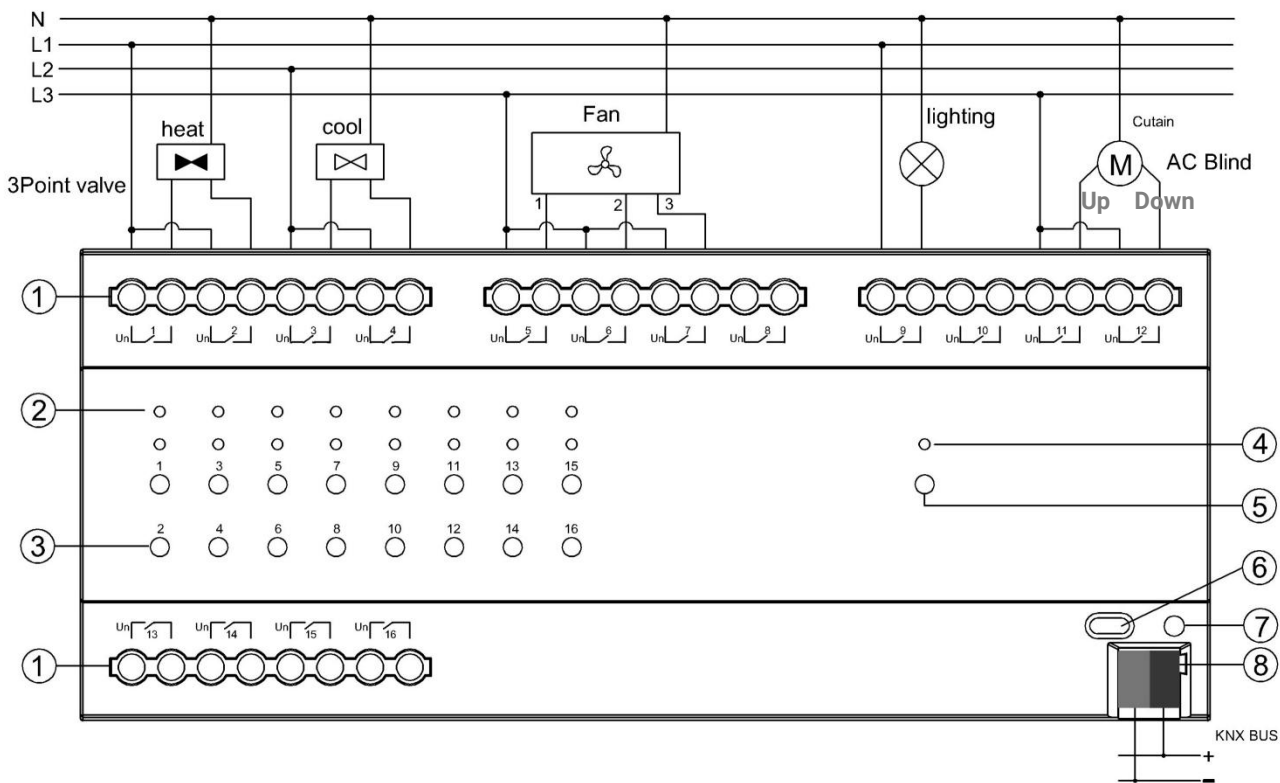
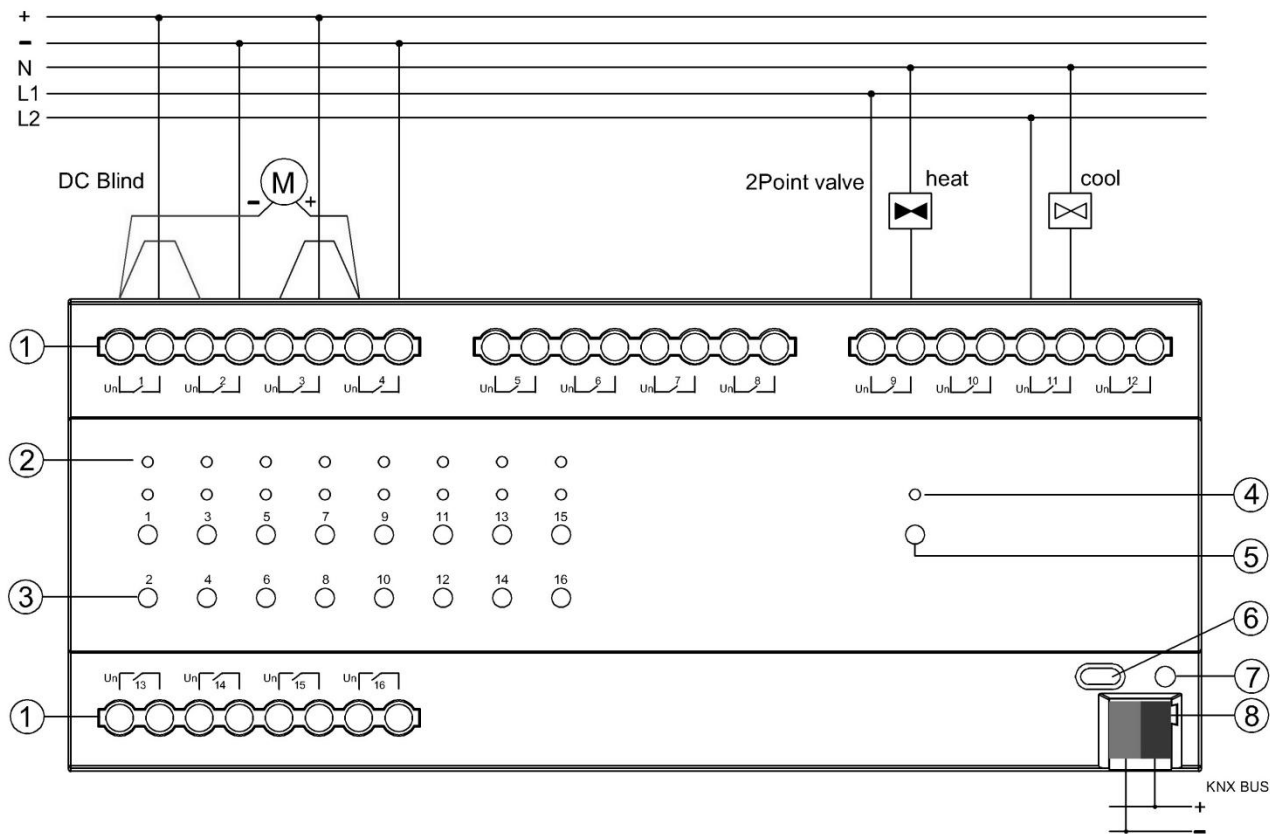

3.2.4. AMMA-24/10.S

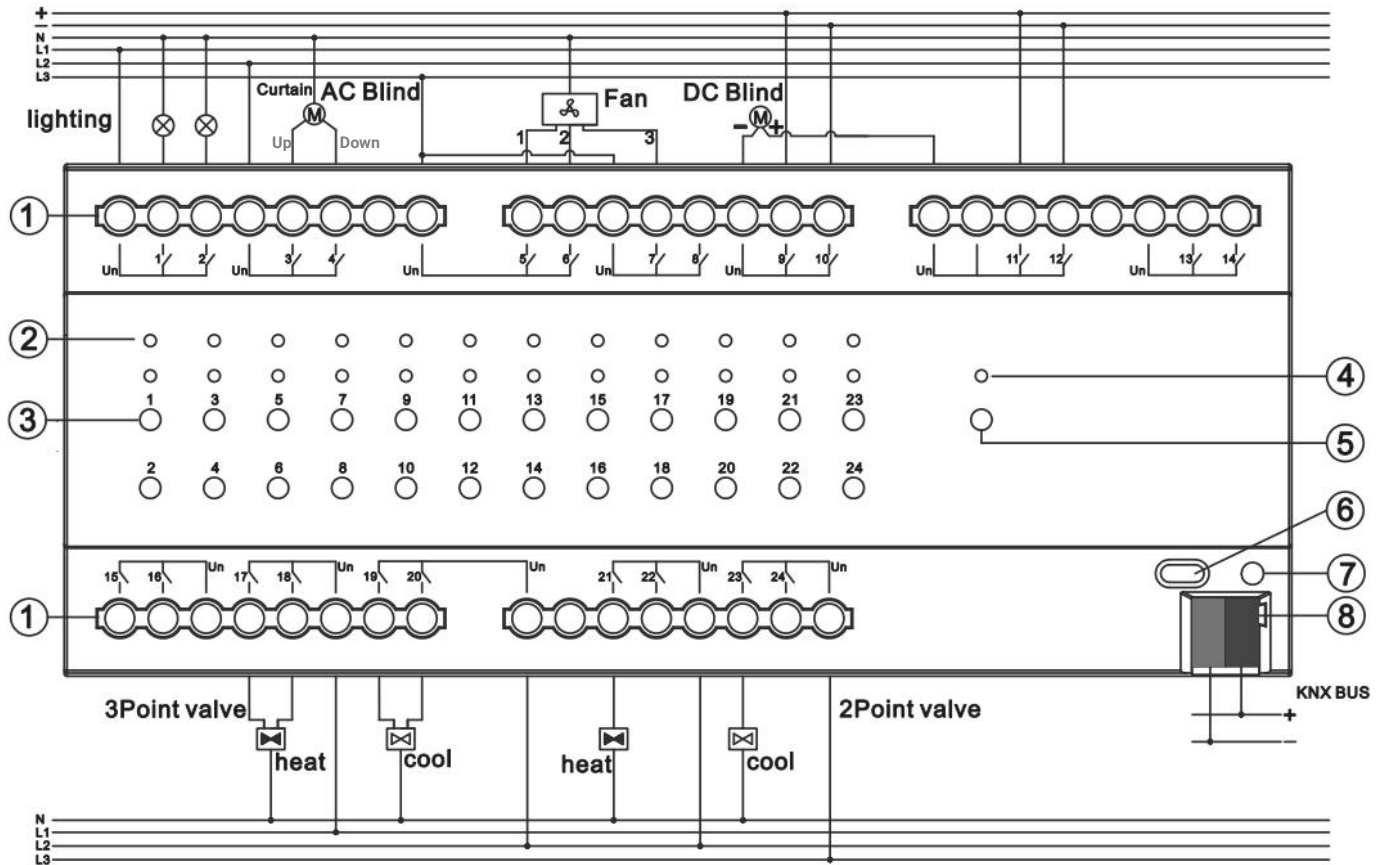

① Output Terminal:

Above Figure indicates how each control output is wired.

②③ The manual operation button and Output indication of the channel Output:

When the button is used to control the switch Output, each channel corresponds to 1 button and indicator light. When the light is on, there is Output, and when it is off, there is no Output.

When the button is used to control the curtain/louver (AC/DC), short press (1) up and (2) down, long press to stop moving/adjust the louver, in the curtain/blind operation, the corresponding indicator flashes when arriving In the extreme position, the indicator light is always on. (In the case of DC Output, the indicators and buttons (3) and (4) are not used.)

When the button is used to control the fan, the button (1) turns on the 1st fan speed, (2) turns the 2nd fan speed, (3) turns on the 3rd fan speed, and presses any button to close. The corresponding indicator of the button indicates the fan speed level.

When the button is used to control the valve, under the control of 2 pipe, the button and indicator light (1) are used to open/close the valve and indicate the valve on/off state (full open/closed), and (2)

not used. Under the control of 4 pipe, the buttons and indicator lights (1) are used to switch the valve and status indication of the heating valve, the buttons and indicator lights (3) are used for the switching and status indication of the cooling valve, and (2) and (4) are not used. For 3 point valve, output 1 and 3 for open valve, output 2 and 4 for close valve.

④⑤ Manual / automatic (Man.) toggle button and instructions:

Press and hold this button to switch between manual/automatic operation, the indicator light is in manual operation mode, and the automatic operation mode is off.

⑥⑦ Programming button and LED indicator:

Red LED indicates programming physical address, green LED flashing indicates device application layer is running normally

⑧ KNX bus connection terminal

Reset the device to the factory configuration: press the programming button and hold for 4 seconds then release, repeat the operation for 4 times, and the interval between each operation is less than 3 seconds

Note:

1. The above ②③ channel Output button operation and indication only in the normal running state of the application, that is, download the database into the application after the operation.

In the no-application running state, the default relay switch function is defaulted, and the interlock operation is performed at the same time, that is, the relays of adjacent channels cannot be closed at the same time. This state is only applied to engineering debugging.

2. After entering the manual operation state, the Bus control message is ignored. And after switching to the manual operation state, if the channel button operation is not performed, the existing operation state is maintained; the manual operation instruction is executed after the channel button operation is performed; when the manual operation state is exited, the current operation state is maintained until there is reception. Go to the Bus control instruction.(For special handling of manual operation, please refer to the description of the last chapter of each function block, such as chapters 4.4.7, 4.5.1, 4.6.3, 4.8.3)

3. Note the following instructions in order to ensure the safe connection of AC and DC:

- 8-Fold:** If channel 1/2/3/4 is used for DC curtains, channel 5 cannot be connected with AC load;
If channel 5/6/7/8 is used for DC curtains, channel 4 cannot be connected with AC load.
- 24-Fold:** If channel 1/2/3/4 is used for DC curtains, channel 5/6 cannot be connected with AC load;
If channel 5/6/7/8 is used for DC curtains, channel 3/4/9/10 cannot be connected with AC load;
If channel 9/10/11/12 is used for DC curtains, channel 7/8/13/14 cannot be connected with AC load;
If channel 13/14/15/16 is used for DC curtains, channel 11/12/17/18 cannot be connected with AC load;
If channel 17/18/19/20 is used for DC curtains, channel 15/16/21/22 cannot be connected with AC load;
If channel 21/22/23/24 is used for DC curtains, channel 19/20 cannot be connected with AC load.

4. Refer to the 4-Fold description for the labeling instructions for the following 8-Fold, 16-Fold, and 24-Fold Multifunctional Actuators. In the product database configuration, each quad-Fold relay Output is a set of control outputs, so in practical engineering applications, the load wiring must be considered in conjunction with the functional configuration of the database.

Chapter 4 Parameter setting description in the ETS

The parameters will be described in the form of the function interfaces.

4.1. KNX Secure

Multifunctional Actuator with Secure is a KNX device that complies with the KNX secure standard. That is, you can run the device in safe way.

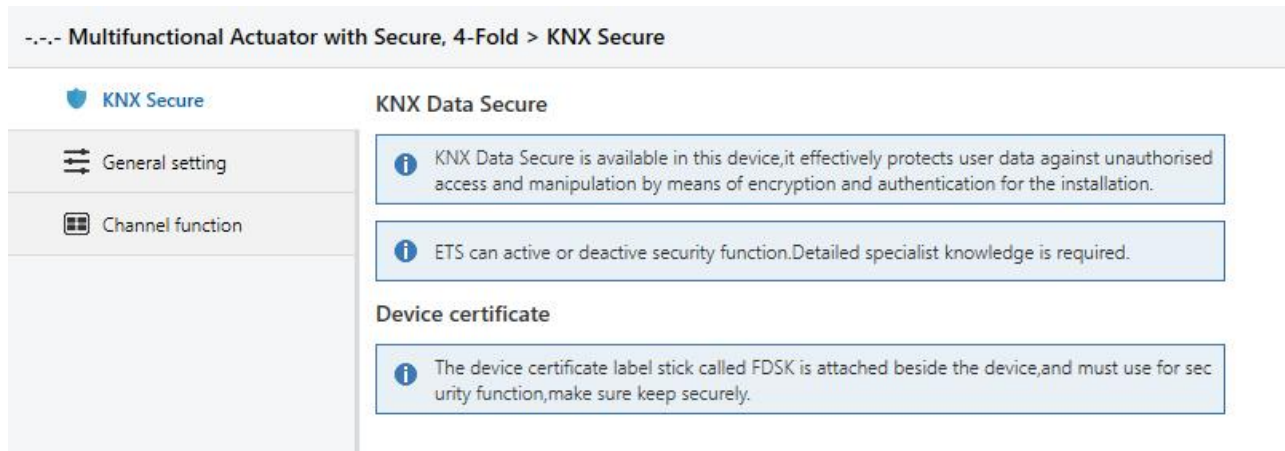

Fig.5.1 (1) "KNX Secure" parameter window

The device with KNX secure will be displayed notes on ETS, as shown as Fig.5.1(1).

If secure commissioning is activated in ETS project, the following information must be considered during device debugging:



❖ It is essential to assign a project password as soon as a KNX Secure device is imported into a project. This will protect the project against unauthorized access.

The password must be kept in a safe place – access to the project is not possible without it (not even the KNX Association or device manufacturer will be able to access it)!

Without the project password, the commissioning key will not be able to be imported.

❖ A commissioning key is required when commissioning a KNX Secure device (first download). This key (FDSK = Factory Default Setup Key) is included on a sticker on the side of the device, and it must be imported into the ETS prior to the first download:

✧ On the first download of the device, a window pops up in the ETS to prompt the user to enter the key, as shown in Fig.5.1 (2) below.

The certificate can also be read from the device using a QR scanner (recommended).

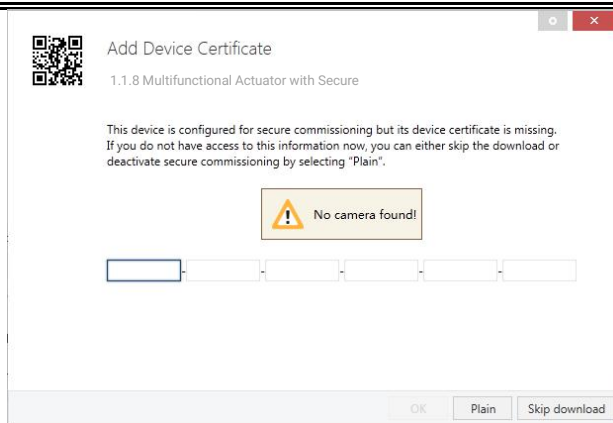

Fig.5.1(2) Add Device Certificate window

- ✧ Alternatively, the certificates of all Secure devices can be entered in the ETS beforehand. This is done on the "Security" tab on the project overview page, as shown in Fig.5.1(3) below.

The certificates can be also added to the selected device in the project, as shown in Fig.5.1(4).

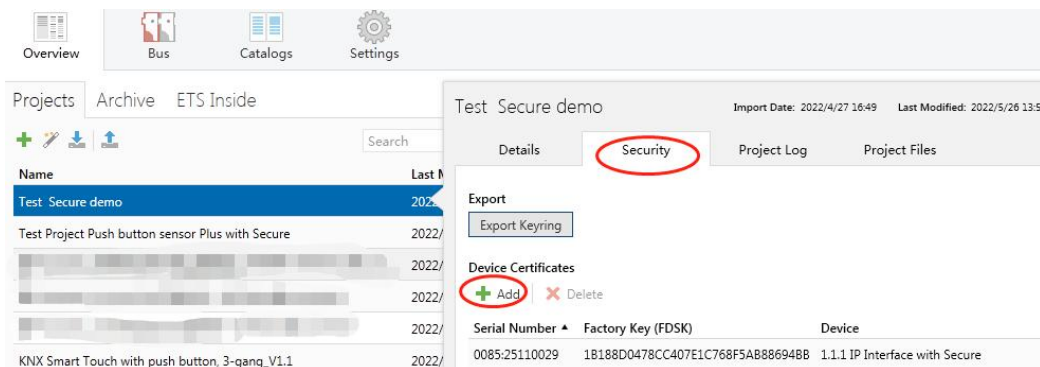

Fig.5.1(3) Add Device Certificate

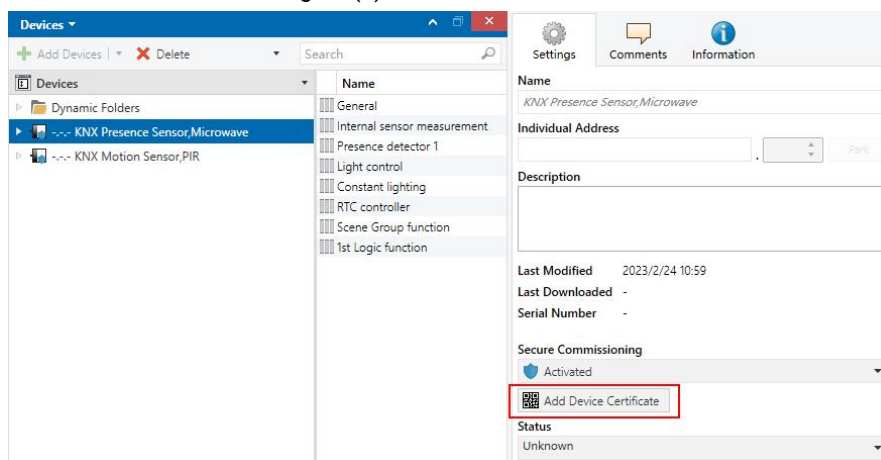

Fig.5.1(4) Add Device Certificate

- ✧ There is a FDSK sticker on the device, which is used for viewing FDSK number.

Without the FDSK, it will no longer be possible to operate the device in KNX Secure mode after a reset.

The FDSK is required only for initial commissioning. After entering the initial FDSK, the ETS will assign a new key, as shown in Fig.5.1(5) below.

The FDSK will be required again only if the device was reset to its factory settings (e.g. If the device is to be used in a different ETS project).

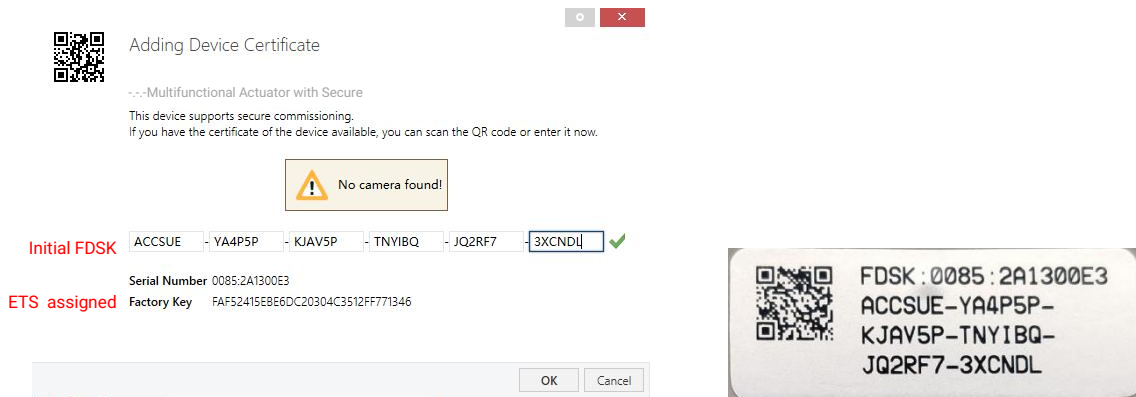

Fig.5.1(5)

Example:

If this application in the project needs to be tried with another device, it is no longer the original device. When the application is downloaded to a new device, the following prompt will appear on the left of Fig.5.1(6), click yes, the Add Device Certificate window will appear, then enter the initial FDSK of the new device, and you need to reset the device to the factory settings (it is not required if the device is still factory default; If it has been used, it will be required to reset, otherwise the following error message will appear on the right of Fig.5.1(6)), and then the device can be successfully downloaded again.

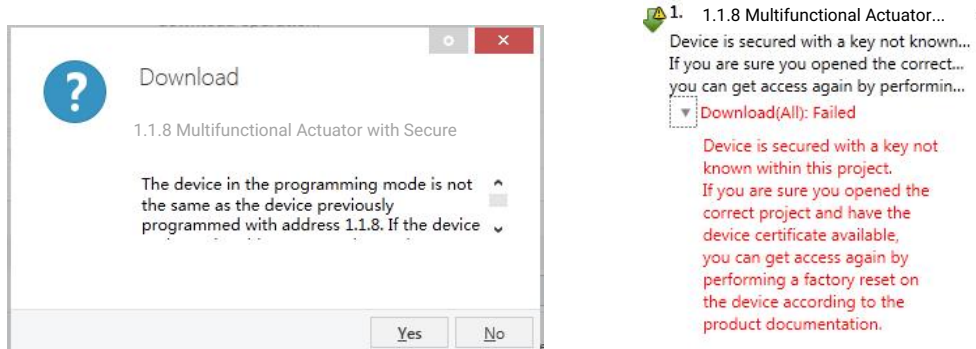

Fig.5.1(6) Example

Whether the device is replaced in the same project, or the device is replaced in a different project, the processing is similar: **Reset the device to the factory settings, then reassign the FDSK.**

After the device is downloaded successfully, the label Add Device Certificate turns gray, indicating that the key for this device has been assigned successfully, as shown in Fig.5.1(7) below.

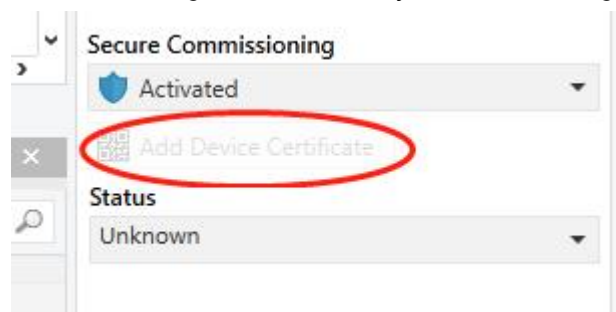

Fig.5.1(7)

ETS generates and manages keys:

Keys and passwords can be exported as needed to the use of security keys outside of the associated ETS projects. As shown in Fig.5.1(8) below, the file extension is .knxkeys.

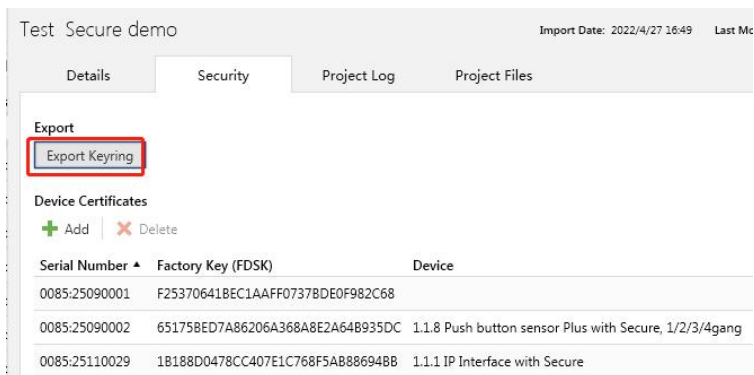

Fig.5.1(8)

Note: Any USB interface used for programming a KNX Secure device must support "long frames". Otherwise ETS will report a download failure information, as shown below.

4.2. Parameter window "General"

The parameter window "General" setting interface is shown in Figure 4.2. This interface is used to set some common parameters and apply to each function block.

--- Multifunctional Actuator with Secure, 4-Fold > General setting

KNX Secure
 General setting
 Channel function

Operation delay after bus recovery [5...250] s
 Sending cycle of "In operation" telegram [1...240,0=inactive] s
 Limit number of send telegram
 Period
 Max.number tele.within a period [1...255]
 Central control for switch function
 Central control for curtain function
 Manual operation
 Manual to automatic by Only long press
 Both long press and automatic delay time
 Delay time [10...6000] s

Fig. 4.2 Parameter window "General"

Parameter "Operation delay after bus recovery [5 · 250]"

This parameter defines the time delay for the operation after the Bus power-down reset. Only when the delay is completed, the operation will be performed, and the device can send a telegram to the Bus. The manual operation performed during this period will be recorded, and the last triggered action will be executed after the delay time expires. During the delay period, the telegram received by the device from the Bus is also recorded, and is executed after the delay is completed.

Options: **5...250 s**

This delay time does not include the initialization time of the device. After bus voltage is restored, the device start-up initialization time is about 3s. This operation delay starts after the device initialization time.

Note: During the delay period, that is, during the inoperable operation of the device, the device programming light indicates that the green light is always on, and after operation, the green light flashes.

Parameter "Sending cycle of "In operation" telegram [1..240, 0 = inactive]"

The Parameter sets the interval at which this module sends a telegram through the Bus loop to indicate that the module is operating normally. When set to "0", the object "In operation" will not send a telegram. If the setting is not "0", the object "In operation" will send a telegram with logic "1" to Bus for the set time period. Options: **0...240 s, 0=Circular transmission prohibited.**

In order to reduce the Bus load as much as possible, the maximum time interval should be selected according to actual needs.

Note: The time interval starts from the time when the Bus resumes power supply, and has nothing to do with the Bus power-on delay operation.

Parameter "Limit number of send telegram"

This Parameter is used to set whether the number of packets sent by the device to the Bus, mainly to reduce the Bus burden.

When enabled, following tow parameters are visible:

-- Parameter "Period"

Set the monitoring time for limiting the sending of telegrams. Options:

100ms

500ms

...

10min

Bus Voltage recovery, after the device initialization time and operation delay is completed, the monitoring time starts to count and starts counting the transmitted Telegram. Once the maximum number of Telegrams allowed to be sent is reached, there will be no Telegram transmission on the Bus until the setting is completed. The monitoring time is over.

When this monitoring time is over, a new monitoring time begins and the Telegram count restarts. Telegrams that were not sent during the last monitoring period will be sent in the next monitoring period, but up to 40 Telegrams can be cached in the last monitoring period. For those duplicate Telegrams in the buffer, only one Telegram will be sent in the next cycle.

-- Parameter "Max. Number tele. within a period [1..255]"

This Parameter sets the maximum number of Telegrams that can be sent during the monitoring time. Options: **1...255**

Note: The above two parameters only affect the Telegram sent to the Bus, and do not affect the operation performed.

Parameter "Central control for switch function"

This Parameter sets the centralized control of the switch function.

When enabled, the object "Central control for all of switch" is visible. All channels that have centralized control can be controlled by this object and can be controlled together.

Parameter "Central control for curtain function"

This Parameter sets the centralized control of the curtain function.

When enabled, the objects "Central control for Up/Down" and "Central control for Slat/Stop" are visible. All channels that enable centralized control can be controlled by these two objects, and the position of the curtain can be adjusted together. Adjust or stop the louver angle.

Parameter "Manual operation"

This Parameter is used to set whether to enable manual operation.

When enabled, the following Parameter is visible.

-- Parameter "Manual to automatic by"

This Parameter is used to set the way to restore from manual operation to automatic operation. Options:

Only long press

Both long press and automatic delay time

Only long press: Switch to manual operation by long pressing the manual/automatic toggle button, or switch back to automatic operation.

Both long press and automatic delay time: Switch to manual operation by long pressing the manual/automatic switch button, or switch back to automatic operation, or automatically return to automatic operation state from manual operation by delay, that is, in manual operation state, if there is no manual for a period of time When the operation is performed, it automatically returns to the automatic operation state. The following Parameter is visible when this option is selected.

-- Parameter "Delay time [10...6000]"

This Parameter is used to set the delay time from the manual operation to the automatic operation state. Options: **10..6000 s**

4.3. Parameter window "Channel function"

The parameter setting interface "Channel function" is shown in Figure 4.3. This interface is used to set the channel function.

Product type: 4-channel Output, 8-channel Output, 16-channel Output and 24-channel Output, the databases used by them are independent, but their functions are the same, so the following uses the 4-channel Output product as an example to explain the parameters and objects.

Channel function: switch Output, curtain Output (distinguish AC motor and DC motor), fan output or valve Output. Different functions occupy different Output channels.

--- Multifunctional Actuator with Secure, 4-Fold > Channel function

KNX Secure	Product select	4-Fold
General setting	Output 1~4 config as	Switch/Curtain AC/Heating/Cooling/2-pipe
Channel function	Output 1&2 function	Switch
	Output 1	<input type="checkbox"/>
	Output 2	<input type="checkbox"/>
	Output 3&4 function	Switch
	Output 3	<input type="checkbox"/>
	Output 4	<input type="checkbox"/>

Fig. 4.3 Parameter window "Channel function"

Parameter "Product select"

This Parameter notes the products used. There are four product types:

4-Fold

8-Fold

16-Fold

24-Fold

Parameter "Output x~y (1~4/5~8/9~12/13~16/17~20/21~24) config as"

This Parameter is used to set the channel function. Options:

Disable

Switch/Curtain AC/Heating/Cooling/2-pipe

Curtain DC

Fan control

Valve control (4-pipe)

The following table gives a simple Output description for each function Output with an example:

Output 1~4	Switch/Curtain AC/Heating/Cooling/2-pipe			Curtain DC	Fan control	Valve control(4-pipe)
	Switch	Curtain AC	Heating/Cooling/ 2-pipe			
Output 1	Output 1	Curtain 1	Valve 1 (Output 1&2, if 3 point, open and close)	Curtain DC 1	Fan 1: fan speed 1	Valve 1: Heat (Output 1&2, if 3 point, open and close)
Output 2	Output 2				Fan 1: fan speed 2	
Output 3	Output 3	Curtain 2	Valve 2 (Output 1&2, if 3 point, open and close)		Fan 1: fan speed 3	Valve 1: Cool (Output 3&4, if 3 point, open and close)
Output 4	Output 4					

From the above table, it can be seen that one switch Output occupies one Output channel, one curtain Output (AC) occupies two Output channels, one curtain Output (DC) occupies four Output channels, and the fan Output determines the Output according to the level of fan speed. The valve output determines the number of switch output channels occupied according to the HVAC control mode and valve type, such as Heating/Cooling/2-pipe occupy one or two switch output channels, while 4-pipe occupy two or four switch output channels.

Under Fan control functions, if some Output is not used, these Outputs can be used to switch Output, depending on the Parameter setting.

Comment Parameter Description (similar function, one of which is taken as an example):

-- Parameter "Curtain 1 output is fixed for": Output 1(Up/Open) &Output 2(Down/Close)

This Parameter indicates that the Output Channel with AC Motor Curtain 1 is fixed to Output 1 and Output 2. Output 1 is connected to Up/Open, Output 2 is connected to Down/Close.

-- Parameter "External DC+ input": Output 1&Output 3

-- Parameter "External DC- input": Output 2&Output 4

-- Parameter "Output Driver": Un

The three parameters indicate the wiring mode of the DC motor curtain output. The positive input of the motor is connected to Output 1 and Output 3 (Output 1 and 3), and the negative input of the motor is connected to Output 2 and Output 4 (Output 2 and 4). The drive is connected to Un.

-- Parameter "Fan 1 output is fixed for": 1level:1; 2level:1&2; 3level:1&2&3

This Parameter indicates that the fan with level 1 fan speed has an Output channel of Output 1;

For fans with 2 levels of fan speed, the Output channels are Output 1 and Output 2;

For fans with 3 fan speeds, the Output channels are Output 1, Output 2 and Output 3.

-- Parameter "If Fan 1 set to 1 or 2 level, output 3&4 as switch output":

Note: If the fan type is level 1 or level 2, Output3 and Output4 can be used as the switch Output.

The following two parameters for describing the output of 4-pipe valve:**-- Parameter "Heat output for 4-pipe valve 1 is Output 1": Output 1&2, if 3 point, open and close**

This Parameter indicates that the heating Output channel of valve 1 is Output 1;

That is, for a two-wire valve, one end of the valve is connected to Output 1, and the other end is connected to Un that supplies power to the valve.

If it is a three-wire valve type, the Output channels are Output 1 and Output 2;

That is, for a three-wire valve, both ends of the valve are connected to Output 1 and Output 2, and the other end is connected to Un that supplies power to the valve.

-- Parameter "Cool output for 4-pipe valve 1 is Output 3": Output 3&4, if 3 point, open and close

This Parameter indicates that the cooling output channel of valve 1 is Output 3;

That is, for a two-wire valve, one end of the valve is connected to Output 3 and the other end is connected to Un that supplies power to the valve.

If it is a three-wire valve type, the Output channels are Output 3 and Output 4;

That is, a three-wire valve, the two ends of the valve are connected to Output 3 and Output 4, and the other end is connected to Un that supplies power to the valve.

-- Parameter "Valve 1 output is fixed for Output 1": Output 1&2, if 3 point, open and close

This parameter is visible when HVAC control is selected as Heating/Cooling/2-pipe, for noting the output channel which corresponds to the valve.

If it is a two-wire valve, the output channel is Output 1, that is, one end of the valve is

connected to Output 1, and the other end is connected to Un that supplies power to the valve.

If it is a three-wire valve type, the Output channels are Output 1 and Output 2, that is, the two ends of the valve are connected to Output 1 and Output 2; the other end of the valve is connected to Un that supplies power to the valve.

4.4. Switch outputs-- Switch actuator

The switch outputs have a maximum of 24-fold output channels. Since the parameter and communication object assigned to each fold output are the same, a one-fold output is taken as an example.

4.4.1. Parameter window "Switch actuator: Output X"

The parameter setting interface "Switch actuator: Output X" is shown in Figure 4.4.1(1). The setting of this interface acts on the entire channel of the relay. In addition to setting the commonly used switching functions, it can also set the report of system power-on and switch status.

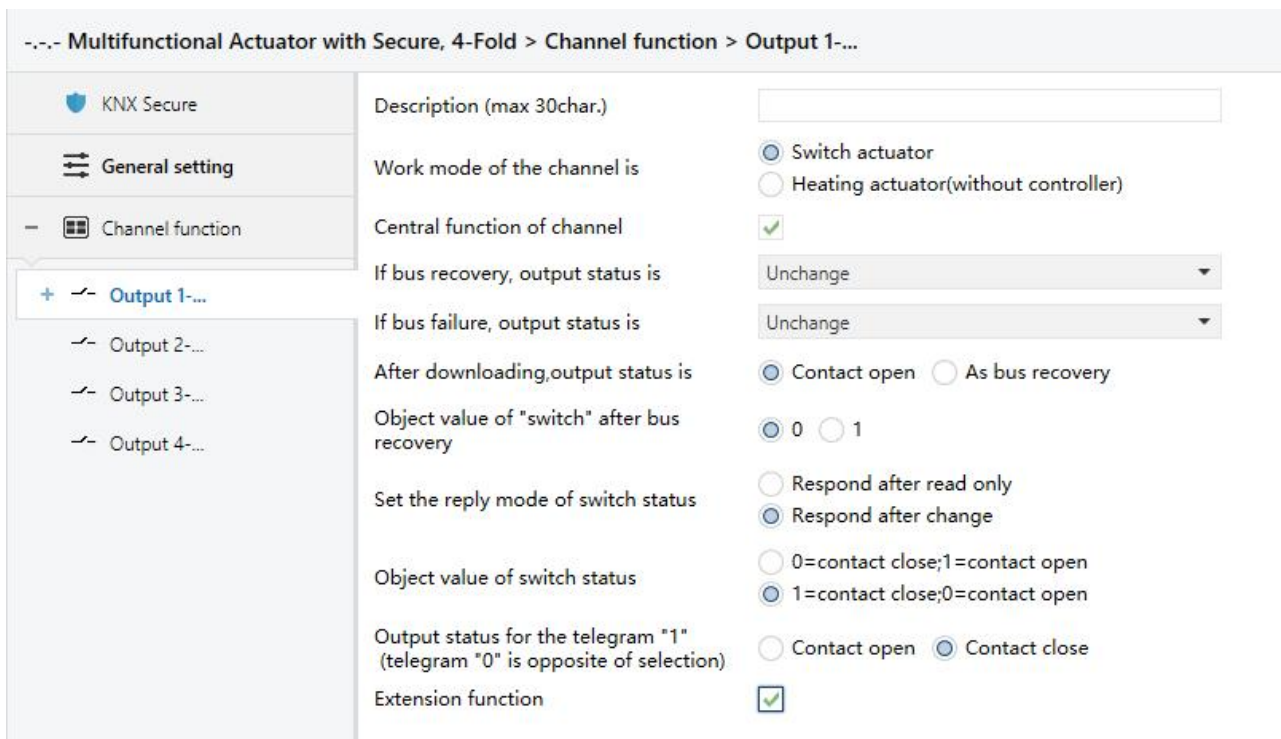

Fig. 4.4.1(1) Parameter window "Output X: Switch actuator"

Parameter "Description (max. 30char.)"

This parameter is used to set the custom description of channel, up to input 30 characters.

Parameter "Work mode of the channel is"

This Parameter sets the work mode of the channel. Options:

Switch actuator

Heating actuator(Without controller)

"Switch Actuator": for common switch control, such as lighting. This section will describe about the parameter functions and application under "Switch actuator" mode.

"Heating actuator (without controller) ": is mainly for heating valve control, parameter functions and application refer to the details in the section 4.5.

Parameter "Central function of channel"

This Parameter sets whether the centralized control of this channel is enabled.

When enabled, the channel will be controlled by the central control object "Central control for all switch".

Parameter "If bus recovery, output status is"

The Parameter sets the position of the relay contacts when the device Bus is powered up. Options:

Unchange

Contact open

Contact close

As before as bus fail

When selecting "Unchange", the contact will not change when bus power on;

When selecting "**Contact open**", the contact will be opened when bus power on;

When selecting "**Contact close**", the contact will be closed when bus power on;

When selecting "As before bus voltage fail", the contact position when bus power on is the same as that before power off.

Parameter "If bus failure, output status is"

The output can adopt a defined status after the bus voltage failure via this parameter.

Options:

Unchange

Contact open

Contact close

When selecting "Unchange", the contact will not change when bus power on;

When selecting "**Contact open**", the contact will be opened when bus power on;

When selecting "**Contact close**", the contact will be closed when bus power on.

Parameter "After downloading, output status is"

This parameter set the contact position of the output after downloading. Options:

Contact open

As bus recovery

When selecting "**Contact open**", the contact is open after application downloading;

When selecting "As bus recovery", the contact will action according to the setting of parameter "If bus recovery, contact is" after application downloading.

Parameter "Object Value of " switch" after bus recovery"

This parameter will be visible when enabling the logic function "Input 0" to define the default value of the communication object "Switch" after bus voltage recovery, which can be "0" or "1".

Options:

0

1

Object value is 0 when finished programming.

Parameter "Set the reply mode of switch status"

This parameter defines how to respond the current switch status to the bus. There are two options to select. Options:

Respond after read only

Respond after change

If selecting "Respond after read only", the status telegram will not be sent out until receiving a read request telegrams via the object "Switch status" from the bus.

If selecting "Respond after change", when switch status of the channel changes, object "Switch status" will immediately send the current report telegram to the bus.

Parameter "Object value of switch status :"

Options:

0=contact close; 1=contact open

1=contact close; 0=contact open

When setting "0=contact close; 1=contact open", the value of object "switch status" is 0 indicates the contact of the relay will be closed; when is 1, indicates the contact of the relay will be closed will be open.

When setting "1=contact close; 0=contact open" indicates the opposite meaning.

Note: After programming or system reset, the switch status is determined, the object "switch status" will send status messages to the bus; if not, it will not be sent.

Parameter "Output status for the telegram "1"(telegram "0" is opposite of selection) "

This parameter defines the contact position when switch on the switch, which will be triggered by the communication object "Switch". When enabling "Input 0" in the logic function, it will use the communication object "Switch" to modify the value of "Input 0", rather than triggering the switch operation. In this case, this parameter setting is no significance. Options:

Contact open

Contact close

When select "**Contact open**", the contact position is open, when receive telegram "1", the contact will be open; when receive telegram "0", the contact close;

When select "**Contact close**", the contact position is close, when receive telegram "1", the contact will be closed; when receive telegram "0", the contact open.

Note: When the logic function input 0 enables, the object "switch" used as input of input 0, the operation of general switch will become invalid.

Parameter "Extension function "

This parameter defines whether enable the special functions of the switch actuator.

The parameter setting interface "Ox: Function" will be seen when enabled, and able to set the special functions individually in Fig. 4.4.1(2).

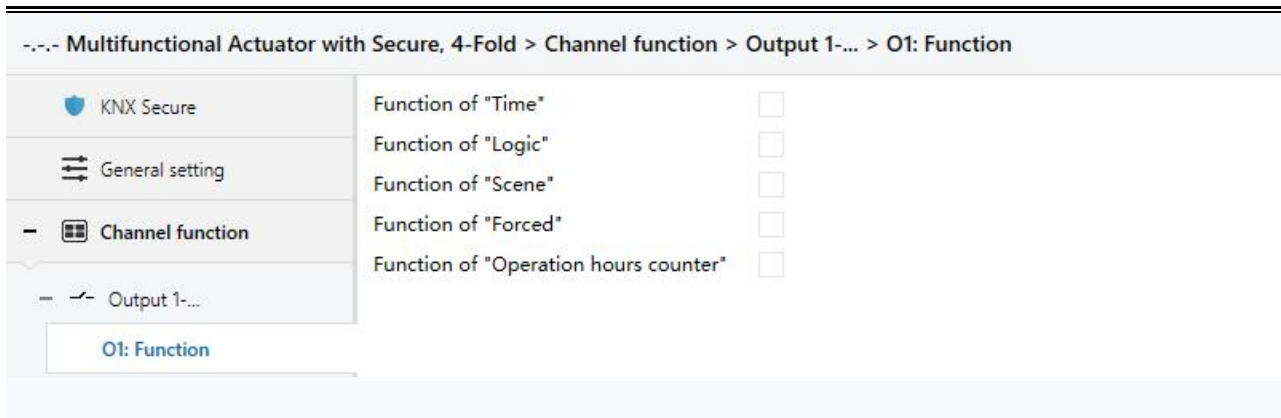

Fig. 4.4.1(2) Special function enable setting interface "Ox: Function"

4.4.2. Parameter window "Ox: Time"

This parameter window is visible when the parameter "Function of 'time'" is enabled in the window "Ox: Function" in Fig. 4.4.1(2), as shown as Fig. 4.4.2.1.

And the object "Enable time function" will be also visible, which is used to disable the time function. After disabled, previous operation is still carried out completely. Such as delay switch on, the function is disabled during delay, and then the switch is still switched on once the delay has been finished.

Parameter "Type of time function"

The parameter defines the type of the time function, there are three options for the mode of work. Options:

Delay

Flashing

Staircase

4.4.2.1. Selection "Delay"

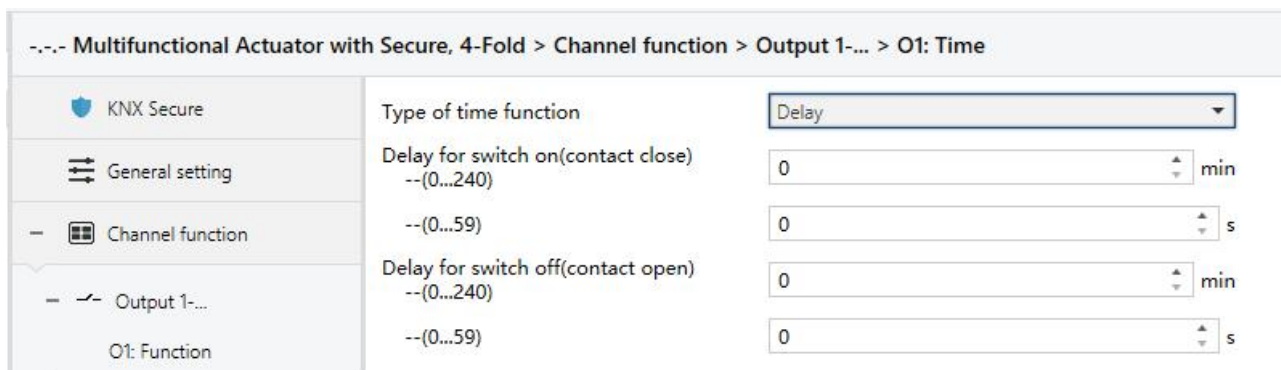

Fig.4.4.2.1 Parameter window "Ox: Time-Delay"

The parameter window "Ox: Time-Delay" setting interface in Fig. 4.4.2.1 will be shown when selecting "Delay". The delay switch can be started via the object "Delay function".

Parameter "Delay for switch on(contact close): (0...240)/ (0...59)"

This parameter defines the delay time of switching on. Options:

0...240 min

0...59 s

Setting the delay time to switch off when object receive the control telegram.

Parameter "Delay for switch off(contact open): (0...240) / (0...59)"

This parameter defines the delay time of switching off. Options:

0...240 min

0...59 s

After receiving the delay off telegram, the switch is off once the delay over.

If receiving the re-trigger telegram again during delay, the delay will be reset.

4.4.2.2. Selection "Flashing"

The parameter window "Ox: Time-Flashing" setting interface in Fig. 4.4.2.2 will be shown up when selecting "Flashing" in the parameter "Type of time function". The flashing switch function is mainly used for lamp aging test.

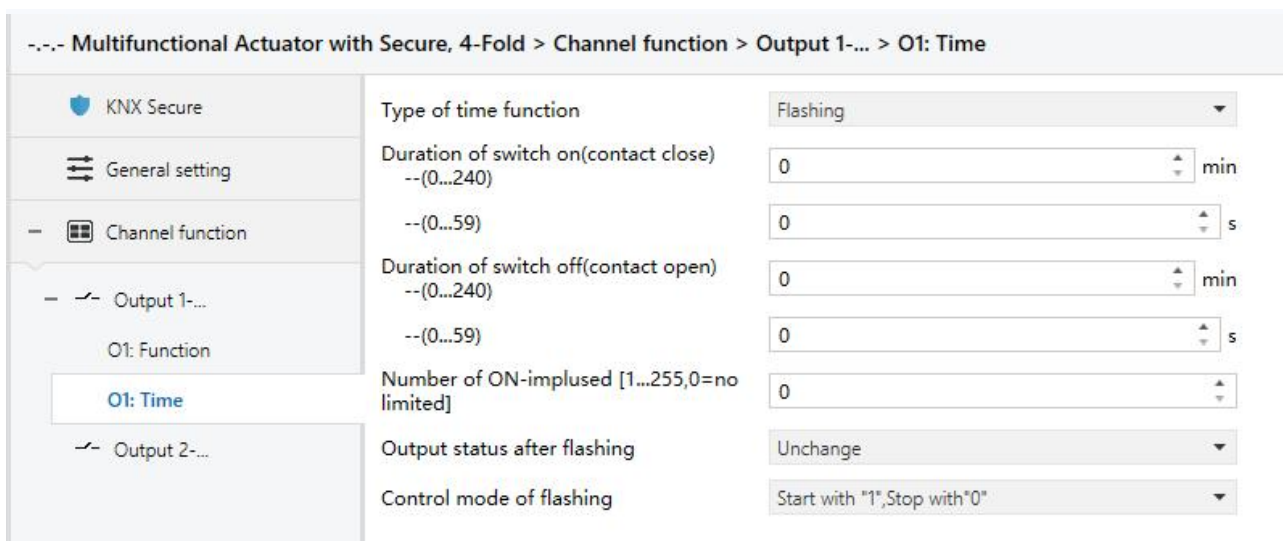

Fig. 4.4.2.2 Parameter window "Ox: Time-Flashing"

Flashing function can be started via the object "Flashing function". It is able to set the flashing time in "Delay for switch on" or "Delay for switch off", which will restart the flashing when receiving the start flashing telegram, and define the contact position after flashing.

Parameter "Duration of switch on(contact close): (0...240) , (0...59)"

This parameter defines the duration of the switch on the output when flashing. Options:

0...240 min

0...59 s

Note: It will not be executed unless the time is lower than the relay threshold switch frequency. Since there will be not sufficient energy to do it because of the frequent relay switching, and it may cause the time delay. The same situation will happen after the bus voltage recovery.

Parameter "Duration of switch off(contact open): (0...240) , (0...59)"

This parameter defines the duration that the switch is turned off the output when flashing.

Options:

0...240 min

0...59 s

Note: It will not be executed unless the time is lower than the relay threshold switch frequency. Since there will be not sufficient energy to do it because of the frequent relay switching, and it may cause the time delay. The same situation will happen after the bus voltage recovery.

Parameter "Number of ON-impulsed [1...255, 0=no limited]"

This parameter sets the flashing times. 0 means no limited. A flashing includes an on and an off. Options: **0...255**

Parameter "Output status after flashing"

This parameter defines the relay contact position after flashing. Options:

Unchange

Open

Close

Parameter "Control mode of flashing"

This parameter is used to select the control mode of the flashing output. Options:

Start with "1", stop with "0"

Start with "0", stop with "1"

Start with "0/1", can not be stop

It will start flashing with value "1" when selecting "start with "1", stop with "0", it will stop flashing with "0". The stop position is defined via last parameter.

It will start flashing with value "0" when selecting "start with "0", stop with "1"; it will stop flashing with "1". The stop position is defined via last parameter.

It will start flashing with either "1" or "0" when selecting "start with "1/0", can not be stopped"; under this circumstance it cannot terminate the flashing by value until operation over, unless it is blocked by other operation or wait for execution finish.

4.4.2.3. Selection "Staircase"

The parameter window "Ox: Time-Staircase" setting interface in Fig. 4.4.2.3 will be visible when selecting "Staircase" in the parameter "Type of time function".

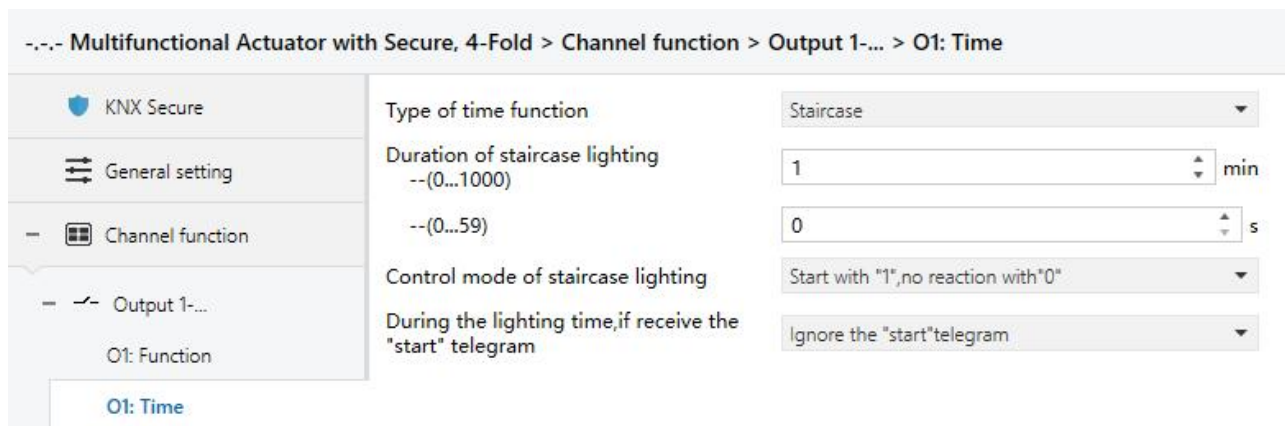

Fig. 4.4.2.3 Parameter window "Ox: Time-Staircase"

The staircase lighting can be started via the object "Staircase function". The value that switches on the staircase lighting can be set via a parameter. The duration time of the lighting on is also set via a parameter.

Parameter "Duration of staircase lighting--(0...1000) --(0...59)"

This parameter describes the duration time when switching on the staircase light function.

Options:

0...1000 min

0...59 s

Parameter "Control mode of staircase lighting "

This parameter defines the control mode on/off of the staircase lighting. Choose suitable control mode according to the needs. Options:

Start with "1", stop with "0"

Start with "1", no reaction with "0"

Start with "0/1", can not be stop

Start with "1", OFF with "0"

When selecting "Start with '1', stop with '0'", it will switch on the staircase lights with the value "1"; it will stop the time counting operation with "0" and don't change the contact position until changed by other operations;

When selecting "Start with '1', no reaction with '0'", it will switch on the staircase lights with the value "1" and no reaction with "0";

When selecting "Start with '0/1', can not be stop", it will switch on the staircase lights either with "0" or "1" but cannot stop it until the duration time finished or changed by other operation;

When selecting "Start with '1', OFF with '0'", it will switch on the staircase lights with the value "1", and off with "0".

Parameter "During the lighting time ,if receive the 'start' telegram"

Options:

Restart duration of staircase lighting

Extend duration time

Ignore the "start" telegram

If selecting "restart duration of staircase lighting", if the object "Staircase function" again receive the telegram of starting staircase lighting during the duration time, then the staircase lighting will restart and the duration time will be restart.

If selecting "Extend duration time", if the object "Staircase function" again receive the telegram of starting staircase lighting during the duration time, then the duration of the staircase lighting will be extended based on the current timing. For example, the duration of the staircase light is set to 60 seconds, and the current time is 20 seconds, then after receiving a start telegram, the lighting time of the staircase light will become $40+60=100$ seconds, and the staircase lighting will automatically turn off after 100 seconds. If multiple start telegrams are received continuously, the duration time will continue to accumulate before the maximum time limit is reached.

If selecting "Ignore the 'switch on' telegram", then it will ignore the receiving telegram of the object "Staircase function" during the duration time.

4.4.3. Parameter window "Ox: Logic"

The parameter window "Ox: Logic" setting interface shown in Fig. 4.4.3, it will shown up in Fig. 4.4.1(2) "Ox: Function" when "Function of "logic"" is enabled.

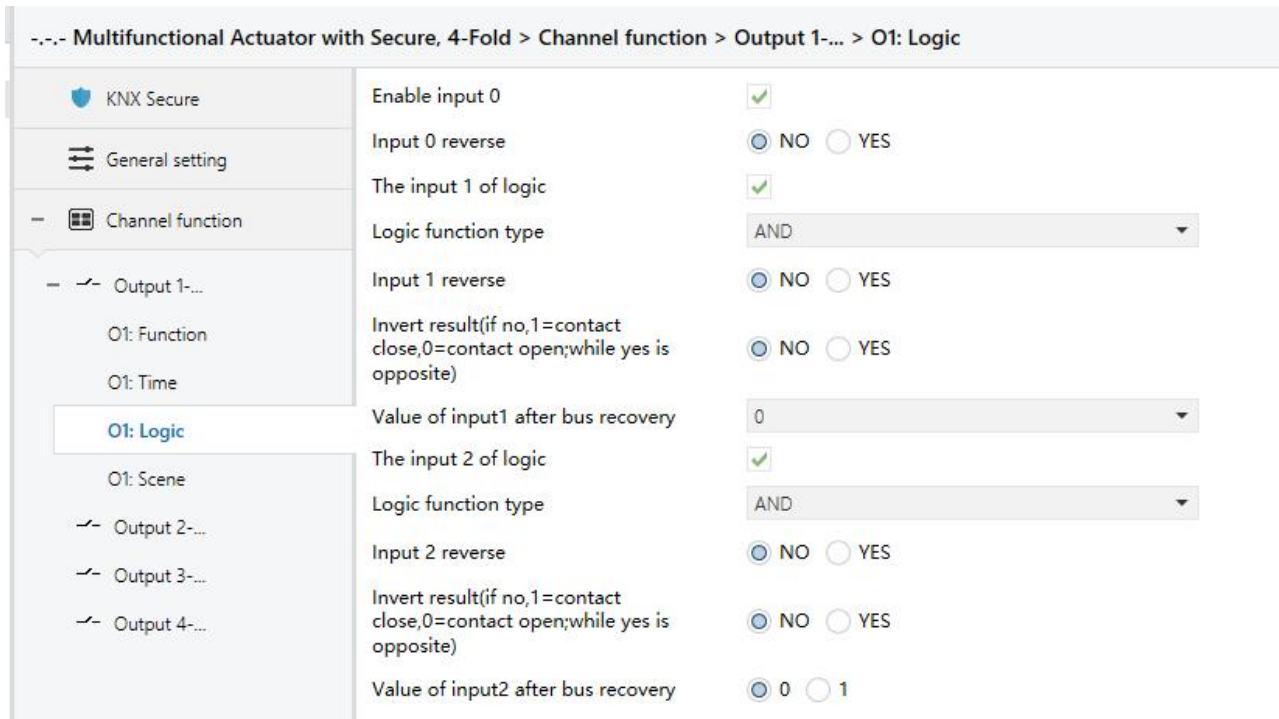

Fig. 4.4.3 Parameter window "Ox: Logic"

There are 2 logic communication objects to decide the status of each output, which are related to the "Switch".

It will re-operate when receiving a new object value as the final output status (close the contact with "1", open it with "0"). The values of the communication object "Logic 1" makes logic operation with "switch" firstly, and then the result after that will makes operations with the value of "Logic 2". This operation will ignore the objects which are unable, and continue to the next step with the ones who are enabled.

Parameter "Enable input 0"

This parameter is used to enable the function of logic operation of "input 0", whose value are wrote by the object "Switch".

In the both cases of "Input 0" enabled and not enabled, there are a little different parameters. All parameters of logic function have described in the following. If input 0 is disabled, the parameters will be less. If there are not certain parameters in the case, then it is also not available with the function of these parameters.

Parameter "Input 0/1/2 reverse"

This parameter defines whether negate the value of Input 0/1/2. Negate it with "YES", don't with "NO". Options:

NO

YES

Parameter "The input x of Logic" (x = 1, 2)"

This parameter is used to enable input 1 and input 2. If enable, their communication objects "Logic 1" and "Logic 2" will be also visible.

Parameter "Logic function type"

This parameter set logic function type, provided three standard logic operations: AND, OR, XOR, and a GATE function.

Explanation of gate function: it will use the next logic value as the enable mark of the previous logic. If the enable mark of the next logic is "1", that means it is able to use the previous logic value as the operation result. E.g. the value of Input 1 is 1, that means the value of Input 0 can be used as the operation result; if the value 2 is 1, that means the operation value of Input 0/1 can be used as the result. Options:

AND

OR

XOR

GATE

Below result of logic operation is possible:

Logic function	Object values					Description
	Input0(Switch)	Input1	Result of Input 0/1	Input2	Output	
AND	0	0	0	0	0	The result is 1 if both input values are 1.
	0	1	0	1	0	
	1	0	0	0	0	
	1	1	1	1	1	
OR	0	0	0	0	0	The result is 1 if one of both input values is 1
	0	1	1	1	1	
	1	0	1	0	1	
	1	1	1	1	1	

XOR	0	0	0	0	0	The result is 1 if both input values have a different value.
	0	1	1	1	0	
	1	0	1	0	1	
	1	1	0	1	1	
GATE	0	Closed		Closed		The input 0 of value is only allowed through if the GATE (input 1 and input 2) is open. Otherwise the input 0 of value is ignored.
	0	Open	0	Open	0	
	1	Closed		Closed		
	1	Open	1	Open	1	

Note:

1. The value of the communication object "Input 1" makes logic operation with "Switch" firstly, and then the result will makes operations with the value of "Input 2", and the final operation result as the final output (close the contact with "1", open it with "0").
2. If an input is not enabled, the input is ignored.
3. If logical result needs to be negated, the first negated, then the next step.
4. The signal can be passed if the GATE is open, otherwise it is ignored. For example, the input 0 of value is ignored when the GATE of input 1 is closed, and the output is directly determined by the input 2.

Parameter "Invert result(if no,1=contact close,0=contact open,while yes is opposite)"

This parameter defines whether negate the logical operation results. Negate it with "YES", don't with "NO". Options:

- NO**
- YES**

Parameter "Value of input 1 after bus recovery"

This parameter defines the default value of the object "Logic 1" after bus voltage recovery.

Options:

- 0**
- 1**
- Value before power off**

Parameter "Value of input 2 after bus recovery"

This parameter defines the default value of the communication object "Logic 2" after bus voltage recovery, "1" or "0" is optional. Options:

- 0**
- 1**

4.4.4. Parameter window "Ox: Scene"

The parameter window "Ox: Scene" setting interface shown in Fig. 4.4.4 will be visible when "Function of 'Scene'" is enabled in Fig. 4.4.1(2). Here can set 8 scenes.

--- Multifunctional Actuator with Secure, 4-Fold > Channel function > Output 1-... > O1: Scene

Channel	Channel Assignment	Output Status	Value
1	1 > channel is assigned to (1...64,0=no assignment)	Output status is	0
2	2 > channel is assigned to (1...64,0=no assignment)	Output status is	0
3	3 > channel is assigned to (1...64,0=no assignment)	Output status is	0
4	4 > channel is assigned to (1...64,0=no assignment)	Output status is	0
5	5 > channel is assigned to (1...64,0=no assignment)	Output status is	0
6	6 > channel is assigned to (1...64,0=no assignment)	Output status is	0
7	7 > channel is assigned to (1...64,0=no assignment)	Output status is	0
8	8 > channel is assigned to (1...64,0=no assignment)	Output status is	0

Overwrite scene stored values during download

Fig. 4.4.4 Parameter window "Ox: Scene"

Parameter "Overwrite scene stored values during download"

This parameter sets whether to override the scene save value during application download.

If it is disabled, the stored values before the download can be not overwritten by the parameterized scene value. When the scene is called, the scene saved before the download is still enabled until it is replaced by the new storage scene.

If it is enabled, the stored values will be overwritten by the parameterized scene value during the download. When the scene is called, the scene will be set according to the parameters until it is replaced by the new storage scene.

Parameter "channel is assigned to (1...64, 0= no assignment)"

It is able to allocate 64 different scene numbers to every output. There are 8 various scenes can be set per output. Options: **1...64**, **0=no assignment**

Note: 1-64 in the parameter setup corresponds to the scene number 0-63 received by the communication object "Scene". If a scene is stored via a learning telegram, the new scene will be active immediately and still be valid even if power failure.

Parameter "Output status:"

This parameter defines the switch output status when recall the scene. Options:

Contact open

Contact close

4.4.5. Parameter window "Ox: Forced"

The parameter window "Ox: Forced" setting interface in Fig. 4.4.5 "Ox: Function" will be visible when the parameter "Function of "forced"" is enabled in Fig. 4.4.1(2).

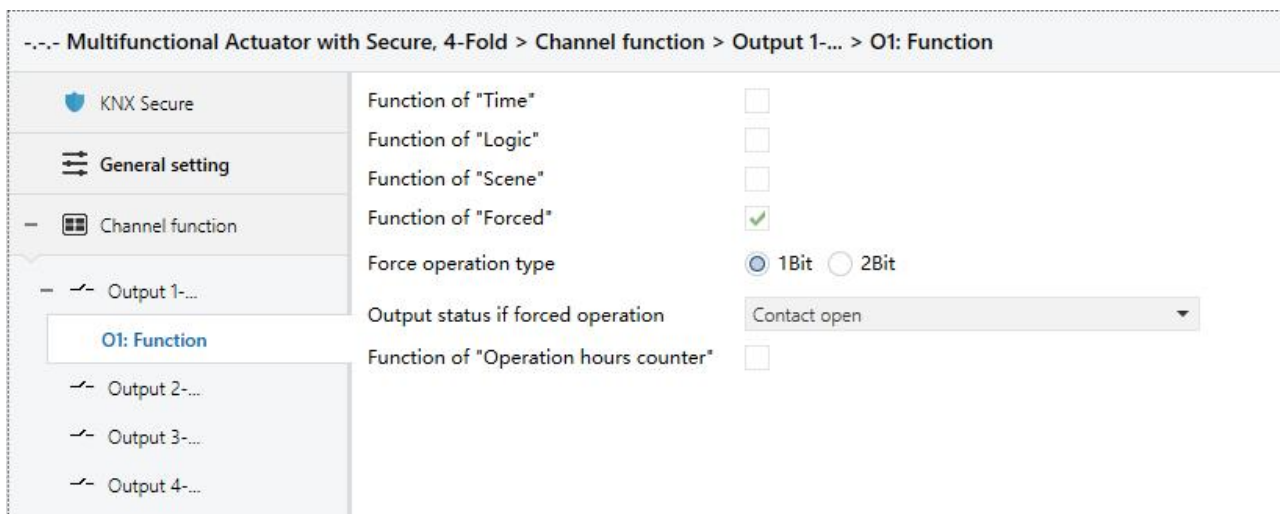

Fig. 4.4.5 Parameter window "Ox: Forced"

This function will be used in some special situation such as emergency, and are activated by the object "Forced output" with the highest priority in the system, which means only forced operation are valid in this case.

Parameter "Force operation type"

This parameter defines the control type of force operation. Options:

1bit

2bit

If selecting "1bit", the object "Forced output" receives the telegram "1" to activate force operation, telegram "0" to cancel the force operation.

If selecting "2bit" when the object "Forced output" receives a telegram value, the action as follow:

Value of the object "Forced output, X"	Action
00b (0) , 01b (1)	Cancel force operation, other operation can be performed
10b (2)	Force switch off (OFF)
11b (3)	Force switch on (ON)

When cancel the forced operation, the position of relay contact is unchanged. However, if time function(Delay/Flashing/Staircase) is running before forced operation, then time order will still continue during forced operation, if cancel the forced operation, time counting has not finished, it will continuously operate time function.

Parameter "Output status if forced operation"

This parameter is visible if the option "1 bit" is selected via last parameter, which defines the contact position of force operation. Options:

Unchange

Contact open

Contact close

Unchange: the position of contact will keep on the current status;

Contact open: the position of contact is opened;

Contact close: the position of contact is closed.

Forced operations have the highest priority, and all other operations are ignored during forced operations. Controlling telegrams received during forced operation is ignored.

4.4.6. Parameter window "Ox: Operation hours counter"

The parameter window "Ox: Operation hours counter" setting interface in Fig. 4.4.6 will be visible when the parameter "Function of "Operation hours counter"" is enabled in Fig. 4.4.1(2). The function is use for counting the time of relay on.

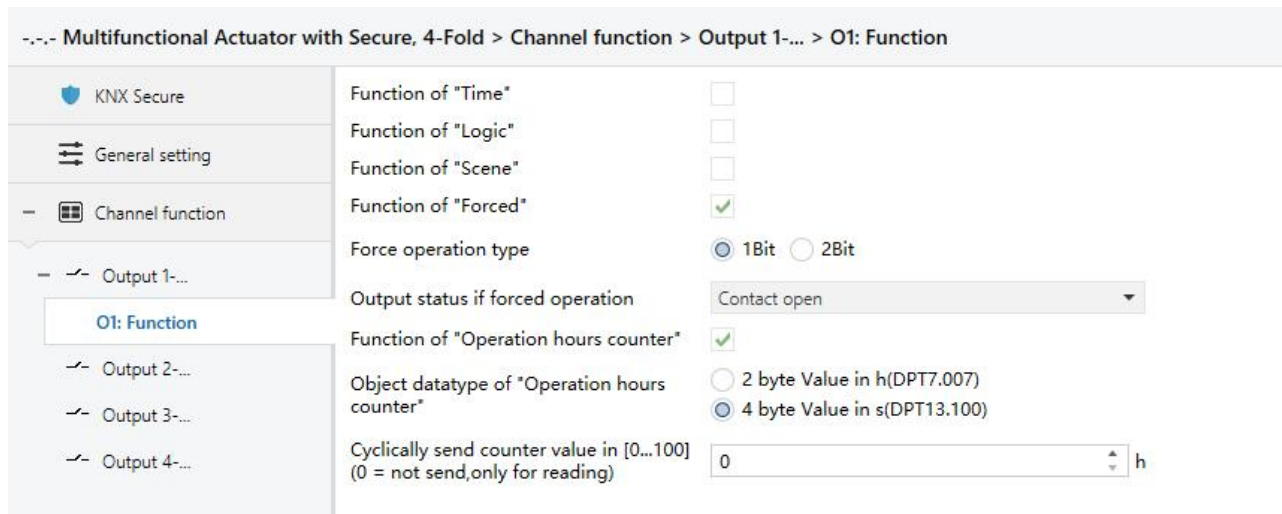

Fig. 4.4.6 Parameter window "Ox: Operation hours counter"

Parameter "Object datatype of " Operation hours counter"

This parameter is used to select data type of the operation hours counter. Options:

2 byte Value in h (DPT 7.007)

4 byte Value in s (DPT 13.100)

The "2 byte Value in h (DPT 7.007)" option indicates that the count value is 2 bytes; the "4 byte Value in s (DPT 13.100)" option indicates that the count value is 4 bytes.

Parameter "Cyclically send counter value in [0..100] (0=not send, only for reading)"

The parameter determines the time interval to send the telegram which is used for counting the time of relay on. Available options: **0...100 h**

"0" means do not send. "1-100" means 1 hours to 100 hours cyclically send the value. When the parameter "Object of switch and operation hours counter" is set to 2 bytes, the operation time is in hours; when it is 4 bytes, the operation time is in s.

4.4.7. Explanation of priority

The priority for various operations of switch actuator control:

Initialization(After the parameter download is completed)→Manual operation (Long press the manual button to switch to manual operation, and the button of the channel has operation)→force operation→general operation

Apply to the following points:

- 1. Manually operating the switch actuator has the highest priority, higher than force operation, if the force is activated, the status will back to force operation when you exit the manual operation.**
- 2. Suppose running the time function currently, if the channel has manual operation, it will be interrupted and ignored if time counter don't complete.**
- 3. Under the manual operation, any message received is invalid and will not be recorded.**

4.5. Switch outputs-- Heating actuator(without controller)

When option “Heating actuator (without controller)” of parameter “ Work mode of the channel is” is selected, parameter setting interface as shown in Fig. 4.5(1), 4.5(2). Usually the device is used to control heating valve. We can realize constant room temperature via a temperature controller or a temperature sensor to command the operation of the device.

Each output has two different kinds of controlling command to select--1bit and 1 byte. When select 1bit, the controlling can be react through the telegram that communication object “On-off control value” has received; when 1 byte is selected, the controlling can be react through the telegram that communication “Control value(Continuous)” has received.

Control command “0%[Closed]” means turn off the valve, “100%[Open]” means turn on the valve. The mid value of 0-100% means the valve will be open for x% time in a cyclical time, and be off for the rest of the time.

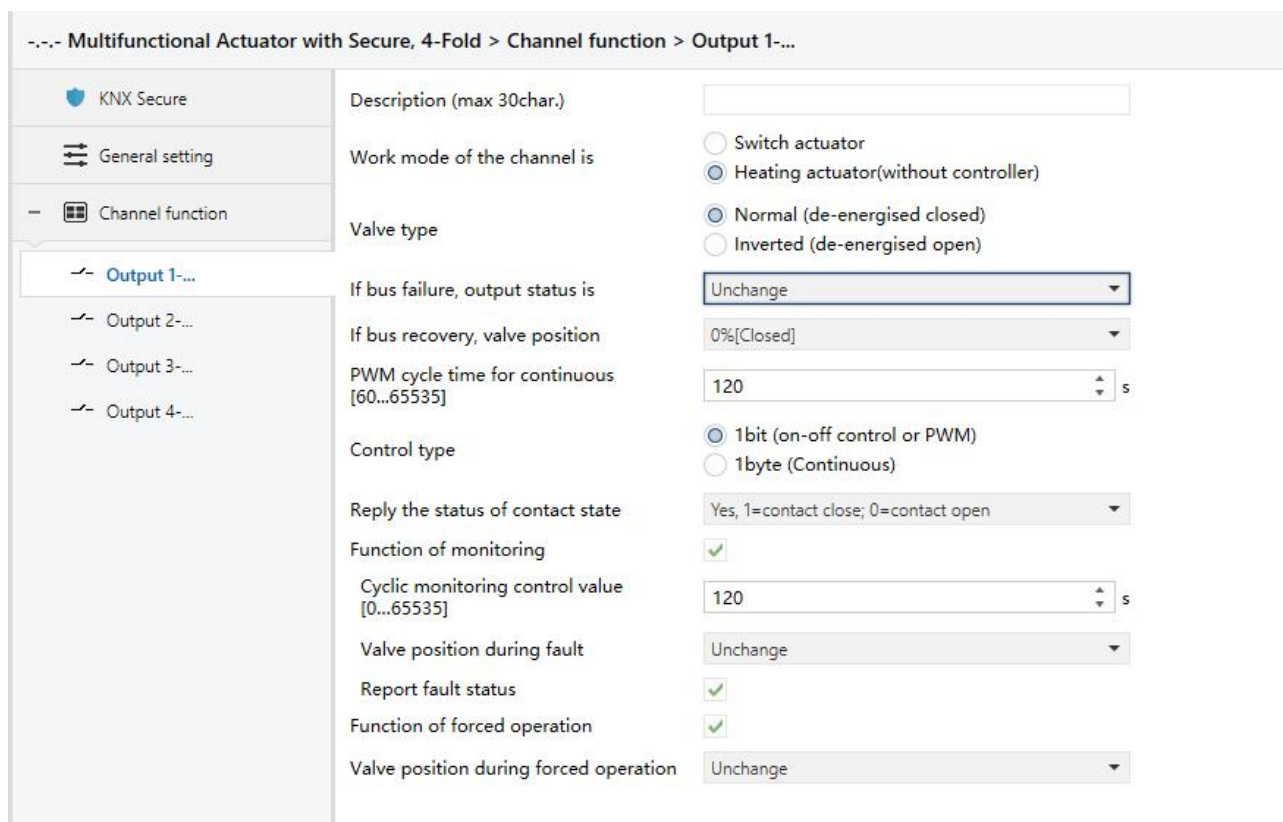

Fig. 4.5(1) Parameter window “Output X: Heating actuator(without controller)_1bit (on-off control or PWM) ”

--- Multifunctional Actuator with Secure, 4-Fold > Channel function > Output 1-...

<ul style="list-style-type: none"> KNX Secure General setting Channel function <ul style="list-style-type: none"> Output 1-... Output 2-... Output 3-... Output 4-... 	<p>Description (max 30char.)</p> <p>Work mode of the channel is</p> <p>Valve type</p> <p>If bus failure, output status is</p> <p>If bus recovery, valve position</p> <p>PWM cycle time for continuous [60...65535]</p> <p>Control type</p> <p>Reply the status for continuous control</p> <p>Reply the status of contact state</p> <p>Function of monitoring</p> <p>Cyclic monitoring control value [0...65535]</p> <p>Valve position during fault</p> <p>Report fault status</p> <p>Function of forced operation</p> <p>Valve position during forced operation</p>	<p></p> <p> <input type="radio"/> Switch actuator <input checked="" type="radio"/> Heating actuator(without controller) </p> <p> <input checked="" type="radio"/> Normal (de-energised closed) <input type="radio"/> Inverted (de-energised open) </p> <p>Unchange</p> <p>0%[Closed]</p> <p>120 s</p> <p> <input type="radio"/> 1bit (on-off control or PWM) <input checked="" type="radio"/> 1byte (Continuous) </p> <p>No reply</p> <p>Yes, 1=contact close; 0=contact open</p> <p><input checked="" type="checkbox"/></p> <p>120 s</p> <p>Unchange</p> <p><input checked="" type="checkbox"/></p> <p><input checked="" type="checkbox"/></p> <p>Unchange</p>
---	---	--

Fig. 4.5(2) Parameter window “Output X: Heating actuator(without controller)_1byte(Continuous)”

Parameter “Description (max. 30char.)”

This parameter is used to set the custom description of channel, up to input 30 characters.

Parameter “Valve type”

This parameter setting the valve type of the heating valve control. Options:

Normal(de-energised closed)

Inverted(de-energised open)

As for valve, “Normal(de-energised closed)” is applied for normal closed valve, “Inverted(de-energised open)” is applied for normal open valve.

Parameter “If bus failure output status is”

This parameter setting the contact position when bus failure. Options:

Unchange

Contact open

Contact close

When select "Unchange", contact of the channel will not change when bus failure;

When select "**Contact open**", contact of the channel will open when bus failure;

When select "**Contact close**", contact of the channel will close when bus failure;

After bus failure only when the relay possess enough energy can it perform the above setting.

Parameter "If bus recovery, valve position"

This parameter setting the valve position when bus recovery. Options:

0%[Closed]

10%[26]

20%[51]

...

80%[204]

90%[203]

100%[Open]

For example, 20%, the PWM cycle time as 100s(1min40s),then the cycle time of valve switching behavior is on for 20s, off for 80s.

Parameter "PWM cycle time for continuous [60..65535]"

This parameter setting the PWM cycle time for continuous. Options: **60..65535 s**

Note: To extend the service life of the relay and the controlled equipment, the pulse period is set as long as possible.

Under the 1bit control type, pulse width control (PWM) is only used to control the actions of thermostat fault, forced operation mode, and bus voltage recovery.

Parameter "Control type"

This parameter setting the data type control telegram received. Options:

1bit(on-off control or PWM)

1byte(Continuous)

Under the "1bit "control, the valve control is similar to the normal switch control: the room temperature controller controls the output of the valve through the switch command. When the thermostat fails and the output does not receive the control signal, the valve will automatically

carry out the PWM action according to the valve position set under the fault. The channel sets the PWM cycle time and is used for this purpose.

Under "1byte" control, the room thermostat sends control values between 0 and 255(corresponding to 0%.100%). This process is also called "continuous-action control ". the valve is closed at 0%, and at 100% it is fully open, at 0%...100% intermediate value, the channel controls the output through the pulse duty cycle adjustment.

Note: under the heating actuator function, each time the telegram of continuous regulation is received, the channel recalculates the duty cycle of the pulse according to the new control value, the time is up, and the action is carried out.

Parameter "Reply the status for continuous control"

This parameter is visible when previous parameter is selected as "1byte(Continuous)", for setting reply the status for continuous control. Options:

No reply

Yes,0%=0, otherwise "1"(1 bit)

Yes,0%=1, otherwise "0"(1 bit)

Yes, continuous control value(1 byte)

Parameter "Reply the status of contact state"

This parameter is used for setting whether to reply the status for contact. Options:

No reply

Yes,0=contact close; 1=contact open

Yes,1=contact close; 0=contact open

When select "No reply", communication object will not reply the status for contact;

When select "0=contact close ; 1=contact open", when the value of communication object "status of contact" is "0" indicates contact close, when "1" indicates contact open;

When select "1=contact close; 0=contact open" has the contrary meaning.

Note: After programmed or system reset, if switch status is assure, object "Status of contact" will send status telegram to the bus: if it is not assure, status telegram will not be sent.

Parameter "Function of Monitoring"

This parameter setting whether to enable monitoring function.

The following three parameters are visible when parameter "Function of Monitoring" is selected as "Enable":

--Parameter "Cyclic monitoring control value[0...65535]"

This parameter sets the time that the device monitors the control telegram from the thermostat. Normally the control telegram of the room thermostat is sent to the device at certain time intervals, and if one or more adjacent control telegrams are not received, the device's function can indicate a communication or a thermostat fault in the room. If the controller's control message is not received within the time set by this parameter, the device automatically starts fault mode. The fault mode ends when the device receives the control telegram again. Every time a control telegram is received, the monitoring time will be reset. Option: **0..65535 s**

Note: If this function is activated, the room thermostat must periodically send a control telegram out. The monitoring time shall be greater than the interval when the controller sends the control telegram .

--Parameter "Valve position during fault"

This parameter is set in the valve position in fault mode, the valve will switch action according to the PWM cycle. Options:

0%[Closed]

10%[26]

...

100%[Open]

Unchange

For example, 20%, the PWM cycle time as 100s(1min40s), then the cycle time of valve switching behavior is on for 20s, off for 80s.

If select "Unchange", the valve position does not change.

--Parameter "Report fault status"

This parameter sets whether to send a telegram to report a fault in fault mode.

If enabled, when the device does not receive a control value during the monitoring time, an

error report is sent, and this output channel performs a dynamic action in fault mode until it is interrupted by another operation. When the control value is received again, the monitoring time starts again.

When it is enabled, object "Report fault" will be active, when object "Report fault" is "1", indicates that this output channel enter fault mode,when"0" indicate this output channel is not fault.

Parameter "Function of forced operation "

This parameter setting whether to enable function of forced operation.

--Parameter "Valve position during forced operation"

This parameter setting the valve position during forced operation. Options:

0%[Closed]

10%[26]

...

100%[Open]

Unchange

If option is "Unchange", the valve position does not change.

At the end of the forced operation mode, the valve output state will return to the previous operation. For example, if the valve position under forced operation is 40% and the previous operation is 60%, then the valve output state will return to the valve position of 60% after exiting the forced operation.

During forced operation, monitoring time of the monitor is still continuous, and when the monitoring time is up, an error report will be sent, but the action under the fault cannot be executed, and it can only be executed after the forced operation is exited. During the forced operation, the received control telegram of common operation will be recorded.

4.5.1. Explanation of priority

The priority for various operations of heating actuator:

Initialization(After the parameter download is completed)→Manual operation (Long press the manual button to switch to manual operation, and the button of the channel has operation)→force operation→general or fault operation

Apply to the following points:

1. During the manual operation, the received control value and force operation command are invalid, but the fault monitoring is continue, and the control value can also reset fault monitoring period. After exiting manual operation, it will perform action according to the fault status, if no fault, it will maintain until a new control command received. If there is a force operation before, then return to the status of force operation. Exit the force, it will perform action according to the current control value or the fault status.

2. At the end of the forced operation mode, the status of switch output will return to the current control value or the fault status. During force operation, the received control telegram of general operation will be recorded.

4.6. Shutter (AC) outputs

There are max. 12 outputs. Each output can be set separately, and parameters and objects which are assigned to each output are the same. Using one of outputs as an example described.

4.6.1. Parameter window “Curtain X: Venetian Blind”

Parameter window “Curtain X” setting interface can be shown in fig. 4.6.1. Here set the general parameters of Shutter actuator.

Fig. 4.6.1 Parameter window “Curtain X: Venetian Blind”

Parameter “Description (max. 30char.)”

This parameter is used to set the custom description of channel, up to input 30 characters.

Parameter “Config channel function as:”

This parameter is used to define the output mode. Different output modes have different parameters and communications. Options:

Venetian Blind

Shutter

If selecting “Venetian Blind”, the output is for the Shutter operation mode, which can operate the curtain with louvres.

If selecting “Shutter”, the output is similar with the Venetian Blind operation mode, except that it cannot adjust louvres.

The section details the parameters and communication objects for the “Venetian Blind” mode.

Parameter “Motor type”

This parameter is used to set the mode of shutter drive. Options:

AC-motor

Dry contact-motor

The option “AC-motor”, is applied to driver of AC power.

The option “Dry contact-motor”, is applied to driver of dry contact control.

--Parameter “Drive pulse time[1..50]”

This parameter is only visible when the option “Dry contact-motor” is selected via the above parameter, which is used to define the drive pulse time for the dry contact motor.

Options: **1..50 *100ms**

The setting of this parameter needs to be considered in conjunction with the technical characteristics of the curtain.

Parameter “If bus recovery, position is”

The parameter is used to set the position where shutter moves, after the output on bus recovery. Options:

Unchange

Up

Down

Stop

If the option “Unchange” is set, the output contacts remain in their current position.

If the option “up” is set, the Shutter is moved to the top after bus voltage recovery.

If the option “down” is set, the Shutter is moved to the bottom after bus voltage recovery.

If the option “stop” is set, if the shutter is moving, it will be stopped after bus recovery.

All output contacts are opened after bus voltage recovery.

Note: If after programming or bus voltage recovery, the Shutter actuator does not detect the

current position of the Shutter. The communication objects “ position status0...100%” and “slat status 0...100%” have the default value “50%” and are not sent on the bus. Telegram will be sent to the bus after assure the position.

If after programming or bus voltage recovery a defined position of the Shutter is required for the first time, it is first of all raised to the top or dropped to the bottom (toward near the target location moving) to determine the current position and then into the target position. Only the Shutter finish a full running can confirm position.

Parameter “If bus failure, position is”

The parameter is used to set the position where shutter moves after on bus voltage failure.

Options:

Unchange

Up

Down

Stop

If the option “Unchange” is set, the output contacts remain in their current position.

If the option “up” is set, the Shutter is moved to the top after bus voltage failure.

If the option “down” is set, the Shutter is moved to the bottom after bus voltage failure.

If the option “stop” is set, if the shutter is moving, it will be stopped after bus voltage failure.

Note: Before the power-down, the curtain is running, and in power-down it is required to perform a reverse operation, then this operation will not be implemented, but to maintain the current running state.

Parameter “After reference movement, Position is”

This parameter specifies how the Shutter actuator behaves after a reference movement.

Options:

Disable

No reaction

Move to saved position

If “Disable” is selected, the reference movement is deactivated;

If “no reaction” is selected, the object “reference movement” receives a telegram “0”, the

Shutter is moved to the top; the object receives a telegram “1”, the Shutter is moved to the bottom.

If “Moved to saved position” is selected, the object receives a telegram “1”, the Shutter is moved to the bottom, then back to its original position; the object receives a telegram “0”, the Shutter is moved to the top, then back to its original position.

During the movement of shutter, the shutter actuator continually determines the current position of the shutter as well as the angle position of the slat using the duration of individual movements. Over longer periods, slight inaccuracies may occur when determining the position due to temperature variations and aging processes. Therefore the Shutter actuator uses the upper and lower limit positions to clearly define the current position of the Shutter. Each time that the Shutter is in the upper or lower limit position, the position is updated in the memory of the Shutter actuator.

If the limit positions have not been reached during normal operation, a reference movement can be triggered via a bus telegram to move the Shutter right to the top or right to the bottom. Depending on the parameter settings, the Shutter either remains in the reference position after the reference movement or moves back into the saved position.

Parameter “Position of slat after arriving on lower end position”

The parameter can set the slat positions of slat after the lower end position is reached.

Options:

- 0%
- 10%
- ...
- 90%
- 100%

For example, if select “40%”, when the object “Move UP/DOWN” receives a telegram “1”, the shutter will move to the lower end position, then the slat positions are adjusted to 40%.

Note: the parameter only relates to the “Down” reaction (the parameter option with “Down”), the safety operation and the percentage value control way are not affected for the parameter.

Parameter “When blind is under end position, up/down object function is”

The parameter defines whether the blind still can be moved via the object “Move UP/DOWN” when the blind is under end position.

If it is disabled, it can not be moved.

If it is enabled, it can be moved, and the running time is the total move time.

Parameter "Set response mode for position"

The parameter defines the response mode for shutter position. Options:

Respond after read only

Respond after change

If select "Respond after read only", only when the device receive the current shutter position from other bus devices or the bus read the current shutter position, object "Position status 0..100%/Slat status 0..100%" send the information of shutter position to the bus.

If select "Respond after change", when the shutter position changes, object "Position status 0..100%/Slat status 0..100%" send the telegram to the bus, so as to report the shutter position.

Parameter "Central function of channel"

The parameter sets whether the central control of the channel is enabled.

If it is enabled, the channel can be controlled via the object "Central control for Up/Down" and "Central control for Slat/Stop".

4.6.1.1. Parameter window "Cx: Drive"

--- Multifunctional Actuator with Secure, 4-Fold > Channel function > Curtain 1-... > C1: Drive

KNX Secure	Total travel time [20...50000]	600	* 0.1s
General setting	Delay time from switch-on to moving [0..200]	0	*10ms
Channel function	Duration of Slat adjustment [10...250]	20	*10ms
Curtain 1-...	Total travel time of Slat 0-100 % in [10...250]	100	*10ms
C1: Drive	Pause on change in direction [5...255]	50	*20ms
C1: Auto.	Additional travel time in upward direction [0...255]	0	0.1s

Venetian Blind type (with louvers)

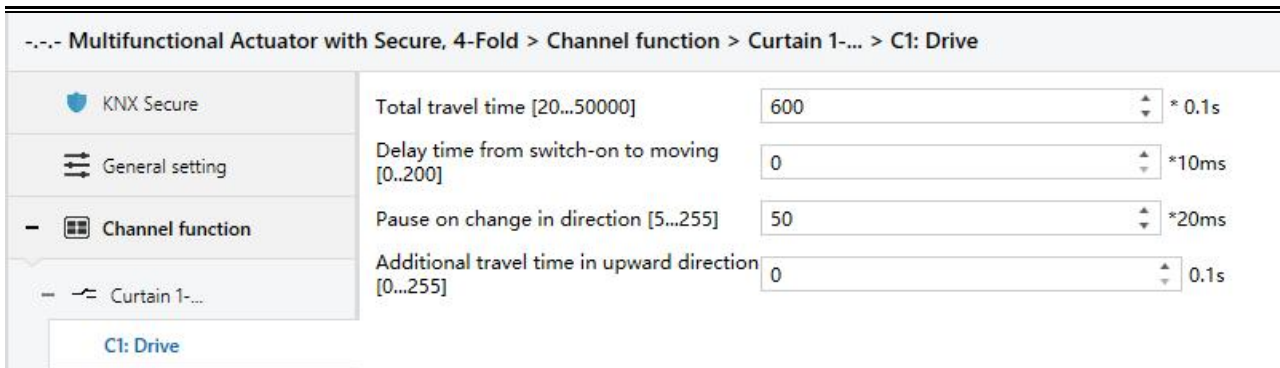

Shutter type (without louvers)

Fig. 4.6.1.1 Parameter window "Cx: Drive"

Parameter "Total travel time [20...50000]"

This parameter sets the time required for the shutter to move the total stroke.

Options: **20...50000 *0.1s**

The total travel time is the time it takes for the blind to move from the highest position to the lowest position (as shown below). When the louver actuator receives a command to move up or down, the louver moves according to the required direction until the louver receives a command to stop moving, or until it moves to the highest or lowest position, then the louver passes through itself. The limit switch turns the motor off. If the blinds are closed by the motor, the corresponding output of the connected actuator is still closed and the output connection will only be disconnected if the set total travel time has elapsed.

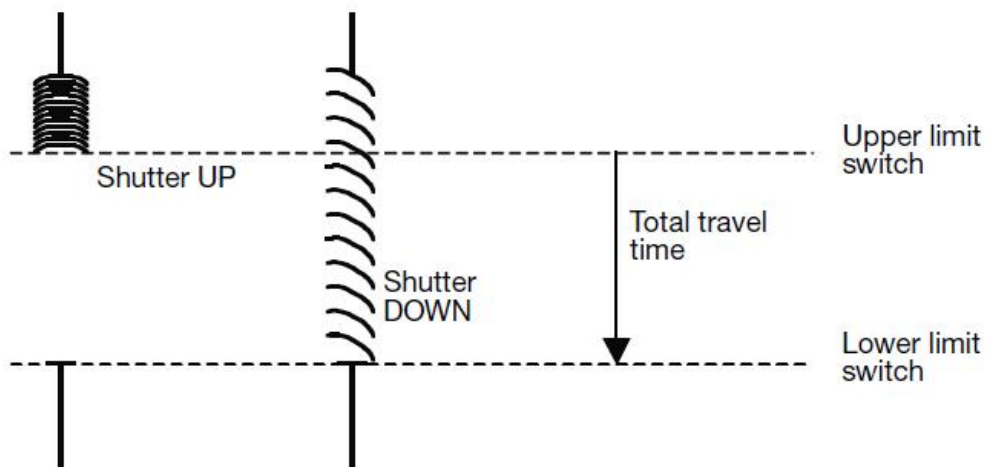

Note: The current position of the Shutter during operation can also be determined with the help of the total move time. It is therefore important to measure and set the total move time as accurately as possible, particularly if the functions "Move to position via a 1 byte value" and

“Status response” are used. Only then is it possible to calculate the current position of the Shutter precisely.

Parameter “Delay time from switch-on to moving [0..200]”

This parameter sets the delay time for the Blinds/Shutter to start running, that is, after receiving the control command and closing the relay contact, how much time delay is required before the curtain starts to slide, that is, the start buffer time of the motor. Options: **0..200 *10ms**

The setting of this parameter needs to be considered in conjunction with the starting technical characteristics of the curtain.

Parameter “Duration of slat adjustments [10...250]”

This parameter sets the Shutter angle adjustment time, that is, the time when the louver angle is adjusted when a command to adjust the angle up or down is received. The shorter the time, the more accurate the angle is adjusted. Options: **10..250 *10ms**

After the shutter moves up, the shutter angle is usually open. If the shutter is lowered now, the louver angle is first closed and then the shutter moves downward. If the blinds are now rising again, the louver angle first opens and then rises. (As shown below)

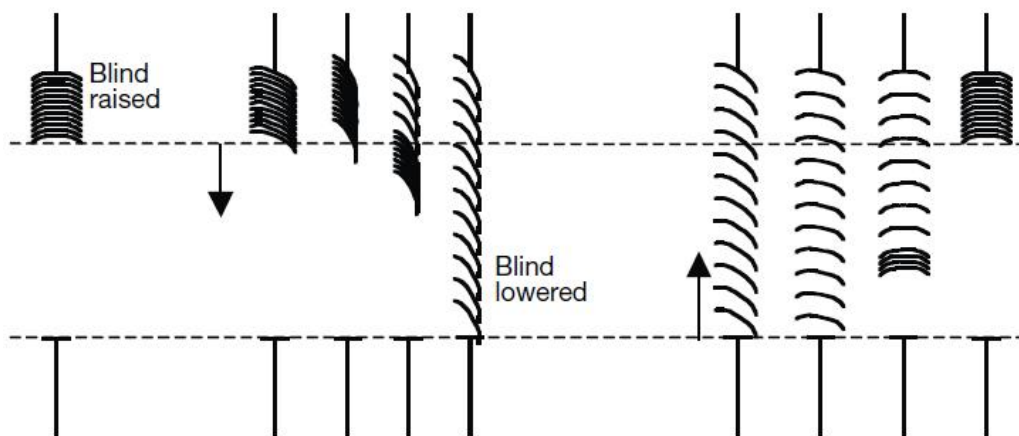

Parameter “Total travel time of slat 0..100% in [10...250]”

Here shutter angle adjustment is provided from the fully closed state to the fully opened state of the overall travel time required, the current position of the shutter during angular adjustment is determined by this parameter. Therefore, it is very important to measure and set the total travel time of the shutter adjustment as accurately as possible. Especially in the case of "Slat position via a 1 byte value" and "Status response", the only way to accurately calculate the current position

of the louver is. Options: **10..250 *10ms**

When the louver angle is adjusted by the object "Slat adj./Stop", the maximum number of times the louver angle needs to be adjusted from the fully closed state to the fully open state = the total travel time of the louver angle adjustment / the one adjustment time. The adjustment time of one time is set by the previous parameter. The shorter the set time, the more the adjustment will be, and the more accurate the angle.

Parameter "Pause on change in direction [5..255]"

This parameter is used to set the time to pause when the direction of movement or angle adjustment is changed. The pause time when the direction is changed needs to be considered in conjunction with the technical data provided by the manufacturer of the drive unit to obtain an appropriate value. Steering can prevent the blind drive from damaging when it suddenly changes direction, extending the life of the drive. Options: **5..255 *20ms**

Parameter "Additional travel time in upward direction [0..255]"

This parameter is used to set an additional movement time when the curtain is moved up to the limit position. If the position does not reach the top, the travel time does not increase. In another case, after reaching the limit position of 0%, the steering is performed and moved to the target position (such as shifting), and the moving travel time is also increased.

Options: **0..255 *0.1s**

Note: The extreme position here means that the curtain position is 0%, as long as it reaches this position, it will increase the moving travel time of the upward movement.

4.6.1.2. Parameter window "Cx: Auto."

The parameter window "Cx: Auto." setting interface is shown in Figure 4.6.1.2. Here, the automatic function and sun protection operation are mainly set. The louver actuator positions the louver based on the intensity of the light sensed by the illuminance sensor. For example, when the sun is very weak or there is no light coming through the window, the blinds/curtains can be raised to allow as much light as possible to enter the room. If there is strong sunlight outside the window, you can lower the blinds/curtains and adjust the louver angle so that direct light does not penetrate into the room, while the shutters are partially open to allow some diffuse light to enter the room.

--- Multifunctional Actuator with Secure, 4-Fold > Channel function > Curtain 1-... > C1: Auto.

KNX Secure	Function automatic	<input type="radio"/> Inactive <input checked="" type="radio"/> Active
General setting	Object value of "Enable auto. control" after bus voltage recovery	<input type="radio"/> "0"(Disable auto. control) <input checked="" type="radio"/> "1"(Enable auto.control)
Channel function	Automatically enable for auto.control	<input type="radio"/> NO <input checked="" type="radio"/> YES
Curtain 1-...	Enable auto. control after [10...6000]	10 min
C1: Drive	Sun protection	
C1: Auto.	Position if sun = 1 (sun is shining)	Down
C1: Scene	Delay time on sun = 1 [0...65535]	10 s
C1: Safety	Position if sun = 0 (sun not shining)	Down
	Delay time on sun = 0 [0...65535]	10 s

Fig. 4.6.1.2 Parameter window "Cx: Auto."

Parameter "Function automatic"

Set whether to activate the automatic control operation, that is, the automatic sun protection function. Options:

Inactive

Active

When the option is "Active", the following parameters are visible, the objects "Enable auto. control", "Sun operation", "Sun: blind/shutter position 0...100%" and "Sun: slat adj. 0...100%" visible.

When the object "Enable auto. control" receives the message "1", the operation of the blinds switches to automatic operation; when the object "Enable auto. control" receives the message "0" or the user sends a direct move command (such as Up/down, moving to a certain position, etc. These commands cause the blinds to move; if the scene is saved, these commands that are not directly moved will not cause the operation state to exit the automatic operation), and the operation state exits the automatic operation. Switch to normal operation. The priority of normal operation and automatic operation is the same, but they cannot happen at the same time.

Note: After the automatic operation exits, the message "1" must be received again via the object "Enable auto. Control" or the duration of the automatic activation has elapsed (see the parameter "Enable auto. Control after [10...6000min]" below for details). Description), in order to enter the automatic operation again.

Parameter "Object value of 'Enable auto. control' after bus voltage recovery"

This parameter defines the initial value of the object "Enable auto. control" after a bus reset.

Options:

"0" (Disable auto. control)

"1" (Enable auto. control)

When the option is "0", the initial value of the object "Enable auto. Control" is 0, indicating that automatic operation is not enabled after the bus reset;

When the option is "1", the initial value of the object "Enable auto. Control" is 1, indicating that automatic operation is enabled after the bus reset.

Parameter "Automatically enable for auto. control"

This parameter defines whether automatic reactivation can be performed after the automatic operation exits via normal operation or the object "Enable auto. control". Options:

NO

YES

Select "YES" and the following parameters are visible.

-- **Parameter "Enable auto. control after [10...6000]"**

This parameter defines the duration of the automatic activation of the automatic operation, that is, when the automatic operation is exited by a normal operation or an object, the automatic operation is activated again after the preset time of this parameter has elapsed.

Options: **10...6000 min**

If the automatic operation is interrupted by the object "Enable auto. control" or normal operation during this time, the duration of the automatic activation is re-timed.

Note: The manual operation has the highest priority, and safety operation has the second highest priority. In the case of manual and safety operation are activated, automatic operation cannot be activated automatically. The automatic activation duration will not start until manual and safety operation are canceled.

Sun protection

Parameter "Position if sun= 1 (Sun is shining)"

In the case where the sun is set here, the position of the louver, that is, the position at which the louver is moved when the object "Sun operation" receives the telegram "1", activates the sun protection. Options:

No reaction

Up

Down

Stop

Receive 1 byte value

If the option is "no reaction", the object "Sun operation" will maintain the current running state when it receives the message "1". If it is not running yet, it will not run. If there is currently running, it will continue to run.

If the option is "Receive 1 byte value" and the object "Sun operation" receives the telegram "1", the position of the blind is determined by the object "Sun: blind/shutter position 0...100%" and "Sun: slat adj. 0...100%". The received value determines that after the bus reset or programming, the values of these two objects are undefined, the default value is "130" (51%), only when they receive the value, can be determined. The location, and any operational status, the values they receive are saved, including in the higher priority protection operation state.

Parameter "Delay time on sun= 1 [0...65535]"

This parameter is used to set the delay time, that is, when the object "Sun operation" receives the message "1", the time when the shutter actuator delays the execution of the action is mainly to prevent the shutter actuator from frequently moving due to the fluctuation of the illumination. Make the device easy to damage and affect the life of the blind motor. Options: **0...65535 s**

Parameter "Position if sun= 0 (Sun not shining) "

This parameter is similar to the previous one. The difference is that the location of the blinds when the object "Sun operation" receives the message "0" and the sun protection are canceled.

Parameter "Delay time on sun= 0 [0...65535]"

This parameter is used to set the delay time, that is, when the object "Sun operation" receives the message "0", the time when the shutter actuator delays the execution of the action is mainly to prevent the shutter actuator from frequently moving due to the fluctuation of the illumination. Make the device easy to damage and affect the life of the blind motor. Options: **0...65535 s**

Here's a simple automatic sun protection system:

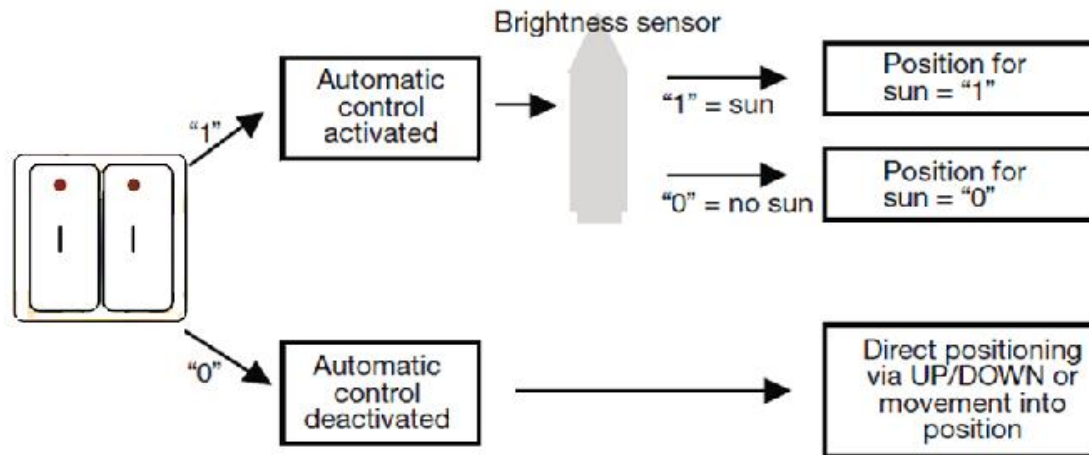

The illuminance sensor senses the intensity of the external light, the button can be switched on, or other control switches on the bus can be used.

Through the second switch of the button, the user can specify whether to enable the automatic sun protection function, or by manually controlling the blinds, if the automatic sun protection is activated by the switch, the blinds will automatically move until the automatic sun protection is disabled through the same switch, or the user sends a direct movement The command (up/down, or move to a location), the auto function is therefore disabled.

The shutter actuator receives information from the illuminance sensor to indicate if there is direct illumination outside the window. Once the adjustable delay has elapsed, the actuator will adjust the blinds according to the set position.

4.6.1.3. Parameter window "Cx: Scene"

The parameter window "Cx: Scene" setting interface is shown in Figure 4.6.1.3. The main setting scene is here. Each scene can be set with 8 scenes at the same time. Different scenes can define different louver positions and louver angles.

--- Multifunctional Actuator with Secure, 4-Fold > Channel function > Curtain 1-... > C1: Scene

KNX Secure

General setting

Channel function

Curtain 1-...

C1: Drive

C1: Auto.

C1: Scene

C1: Safety

Function scene Inactive Active

Overwrite scene stored values during download

1> Channel is assigned to (1...64,0=no assignment) 0

Blind position [0%=top,100%=bottom] 0 %

Slat position [0%=open,100%=close] 0 %

2> Channel is assigned to (1...64,0=no assignment) 0

Blind position [0%=top,100%=bottom] 0 %

Slat position [0%=open,100%=close] 0 %

3> Channel is assigned to (1...64,0=no assignment) 0

Blind position [0%=top,100%=bottom] 0 %

Slat position [0%=open,100%=close] 0 %

4> Channel is assigned to (1...64,0=no assignment) 0

Blind position [0%=top,100%=bottom] 0 %

Slat position [0%=open,100%=close] 0 %

Fig. 4.6.1.3 Parameter window "Cx: Scene"

Parameter "Function scene"

This parameter sets whether to active scene function. Options:

Inactive

Active

When "Active" is selected, following parameters are visible:

Parameter "Overwrite scene stored values during download"

This parameter sets whether to override the scene save value during application download.

When it is disabled, during the application download, the saved scene values are not overwritten by the parameter setting scene. When the scene is called, the scene saved before the download is still enabled until it is replaced by the new storage scene.

When it is enabled, during the application download, the saved scene values will be

overwritten by the parameter setting scene. When the scene is called, the scene will be set according to the parameters until it is replaced by the new storage scene.

Parameter "Channel is assigned to (1...64, 0= no assignment)"

The shutter actuator can be assigned 64 different scene numbers per output. Each output can be set to 8 different scenes at the same time. Options: **1...64** , **0=no assignment**

Note: The effective scene number in the parameter setting option is 1~64, and the corresponding message is 0~63. When the bus is powered off, the new scene will be saved and when it is powered up again, the new scene will be called.

--Parameter "Shutter position: 0...100%(0%=top,100%=bottom)"

This parameter sets the position of the blind when the scene is called:

0...100%, 0%=top, 100%=bottom

--Parameter "Slat position: 0...100%(0%=opened,100%=closed)"

This parameter sets the angular position of the louver when the scene is called:

0...100%, 0%=opened, 100%=closed

4.6.1.4. Parameter window "Cx: Safety"

The parameter window "Cx: Safety" setting interface is shown in Figure 4.6.1.4. Here, the safety operation function of the blinds is mainly set.

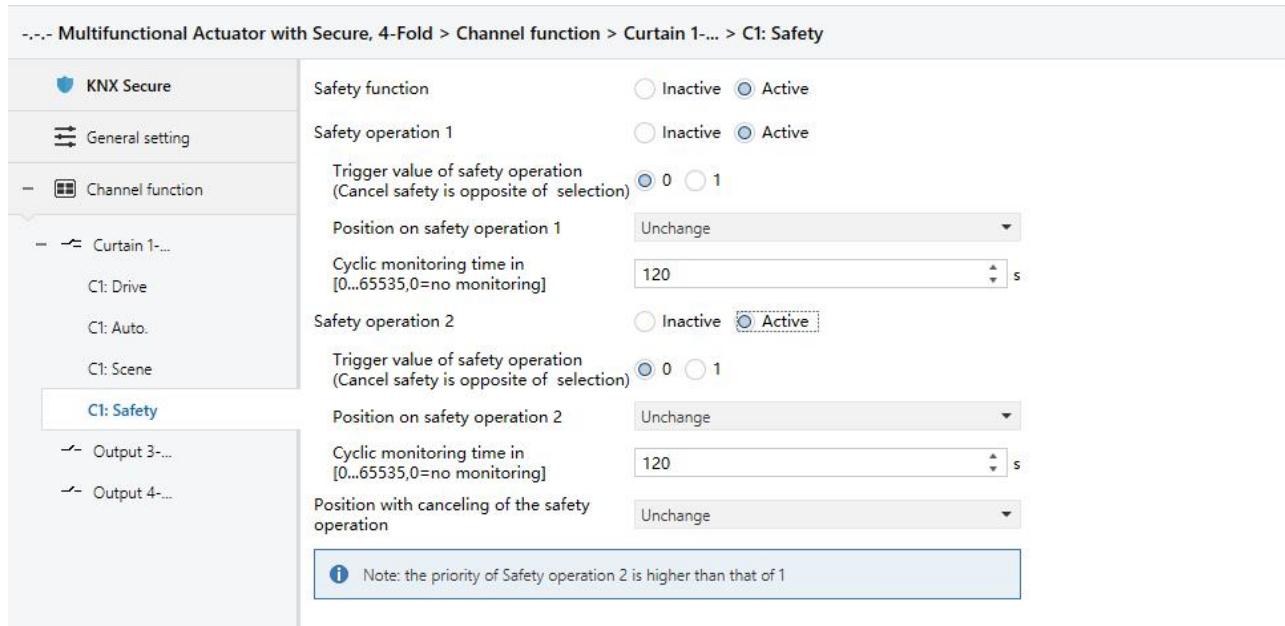

Fig. 4.6.1.4 Parameter window "Cx: Safety"

In this interface, the action that the blinds should perform after the Safety operation function of each output is triggered is set. The settings for each channel are relatively independent and do not affect each other.

Parameter "Safety operation x" (x=1, 2)

These two parameters are used to set whether to activate the Safety operation function of the blinds. Options:

Inactive

Active

When "Inactive" is selected, the security operation function will not be activated;

If "Active" is selected, the safety operation function is activated, the following parameters will be visible, the trigger condition can be set for the safety operation function, and the corresponding communication object "Safety operation 1/2" will be enabled.

Parameter "Trigger value of safety operation(cancel safety is opposite of selection)"

This parameter is used to set the trigger value for the Safety operation function of the blinds.

Options:

0

1

When set to "0", if the communication object "Safety operation 1/2" receives a telegram with a logic value of "0", the security operation will be triggered. When the telegram "1" is received, the security operation will be canceled. At this time, the monitoring period of the Safety operation function is reset;

When set to "1", if the communication object "Safety operation 1/2" receives a telegram with a logic value of "1", a security operation will be triggered. When the telegram "0" is received, the security operation is canceled. At this time, the monitoring period of the safety operation function is reset.

Parameter "position on safety operation x" (x=1, 2)

These two parameters set the action that the blinds perform after the safe action is triggered.

Options:

Unchange

Up

Down

Stop

Parameter "Cyclic monitoring time in [0..65535, 0=no monitoring]"

This parameter sets the monitoring period of the safety operation function, and the monitoring period should be at least twice as large as the cyclic transmission telegram period of the sensor. In order to prevent the missing sensing signal when the bus is busy, the blinds/curtains are moved to the Safety operation position. If the value of this parameter is set to "0", it means that the monitoring of the Safety operation is not activated, and it can be directly controlled by the object of the Safety operation.

Options: **0..65535 s**

During the set monitoring time, the object "Safety operation 1/2" does not receive the telegram to cancel the safety operation, it will trigger the Safety operation function of the

blinds/curtains, and the blinds/curtains will perform the action after the safety operation is triggered.

Parameter "Position with canceling of the safety operation"

This parameter sets the action that the blinds perform after the Safety operation is canceled.

Options:

Unchange

Up

Down

Stop

This action will only be performed if a Safety operation is performed, a cancel command is executed, and all security operations on this channel are canceled, otherwise it is not executed.

The safety function of the blinds/curtains has a higher priority than other functions. If the Safety operation function of a certain output is activated, the other operations of this output will be prohibited, and the safety 2 priority is higher than safety 1.

4.6.2. Parameter "Curtain X: Shutter"

The parameter window "Curtain X:Shutter" mode of operation of the shutter actuator is similar to the parameters and communication objects of the "Venetian Blind" mode of operation, and the functions are similar. The difference is that there is no function to adjust the louver angle in the "Shutter" mode. The "Shutter" mode only involves the movement of the curtains and does not have louvers.

The difference between "Shutter" and "Venetian Blind" is as follows:

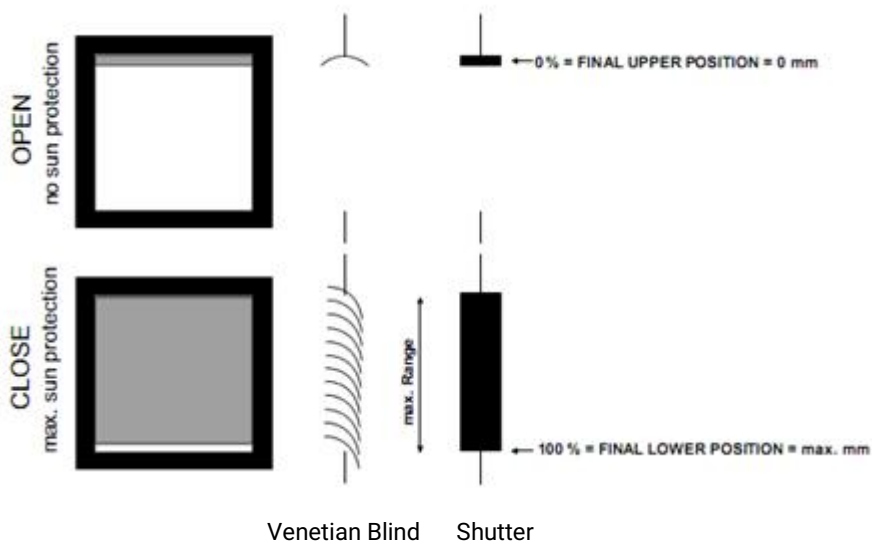

The "Shutter" working mode is not introduced here. The function can refer to the "Venetian Blind" working mode (except for the louver adjustment function).

4.6.3. Explanation of priority

The priority for various operations of curtain control:

Initialization(After the parameter download is completed)→Manual operation (Long press the manual button to switch to manual operation, and the button of the channel has operation)→safety 2→safety 1→General or automatic operation

Apply to the following points:

1. Any general operation command with movement can exit automatic operation.
2. During manual operation, trigger value or reset value of automatic operation and safety operation will be recorded, it will perform action accord to the priority when exit manual operation, and return to general operation or automatic operation after all priority levels exit.
3. When the manual operation exits, if no priority operation, the output status will not change until receive control command when return to general operation or automatic operation.
4. In the case of manual and safety operation are activated, automatic operation cannot be activated automatically. The automatic activation duration will not start until manual and safety operation are exited.(Under the manual or safety operation, time counting will be interrupted, it will continue after exiting manual or safety operation.)

4.7. Shutter (DC) outputs

The curtain (DC) output has a maximum of 6 output channels, since the parameters and communication objects assigned to each output are the same as those of the curtain (AC) output, except that the parameters are not selected by the "Motor type" drive type. The parameter interface is shown in Figure 4.7.

--- Multifunctional Actuator with Secure, 4-Fold > Channel function > Curtain DC 1-...

KNX Secure

General setting

Channel function

Curtain DC 1-...

DC1: Drive

DC1: Auto.

DC1: Scene

DC1: Safety

Description (max 30char.)

Config channel function as

If bus recovery, position is

If bus failure, position is

After reference movement, Position is

Position of slat after arriving on lower end position

When blind is under end position, up/down object function is

Set response mode for position

Central function of channel

Venetian Blind Shutter

Unchange

Unchange

Disable

100%

Respond after read only

Respond after change

Fig. 4.7 Parameter window "Curtain DC X"

The parameter function of the curtain (DC) output is no longer introduced here. The parameter function can be referred to the curtain (AC) output.

4.8. Fan coil outputs

The fan output has a maximum of 6 output channels. Since the parameters and communication objects assigned to each output are the same, an output is taken as an example.

4.8.1. Parameter window “Fan type -- One level”

The parameter window “Fan type -- One level” setting interface is shown in Figure 4.8.1. Here, the parameters of the level 1 fan are set. The parameter settings are as follows:

The screenshot shows the parameter window for a fan coil output. The breadcrumb path is: Multifunctional Actuator with Secure, 4-Fold > Channel function > Fan 1-... The left sidebar shows navigation options: KNX Secure, General setting, Channel function, and Fan 1-... (selected). The main area contains the following parameters and their values:

- Description (max 30char.): [Empty text box]
- Fan type: One level Multi-level
- When bus failure, Fan speed is: Unchange
- When bus recovery, fan speed is: Unchange
- After downloading, fan speed is: OFF
- Forced operation function:
- Forced operation on object value: 0=Force/1=Cancel 1=Force/0=Cancel
- Behaviour on Forced operation: Unchange
- Auto. operation function:
- Time mode for function ON: Switch Delay
- Delay time [1...65535]: 10 *0.1s
- Time mode for function OFF: Switch Delay
- Delay time [1...65535]: 10 *0.1s

Fig. 4.8.1 Parameter window “Fan type -- One level”

Parameter “Description (max. 30char.)”

This parameter is used to set the custom description of channel, up to input 30 characters.

Parameter “Fan type”

This parameter defines the type of fan to be controlled. Options:

One level

Multi-level

One level: can control the fan with 1 fan speed;

Multi-level: A fan that can control fan speeds of up to 3 levels, optional 2 or 3.

Parameter "When bus failure, Fan speed is"

This parameter sets the action of the fan when the bus is powered down. Options:

Unchange

OFF

ON

Parameter "When bus recovery, Fan speed is"

This parameter defines the action of the fan after the bus voltage is restored. Options:

Unchange

OFF

ON

As before as bus fail

Unchange: The status does not change;

OFF: The fan is turned off;

ON: The fan is turned on;

As before as bus fail: The state before the bus was powered down.

Note: Before connecting the fan, in order to obtain a defined fan switch status, it is recommended to connect the bus voltage first to avoid the possibility of fan damage due to incorrect connection.

Parameter "After downloading, fan speed is"

This parameter notes that the fan will be turned off after the application programming is complete.

Parameter "Forced operation function"

This parameter is used to whether enable forced operation.

When it is enabled, the 1-bit communication object "Forced operation" is visible, the following two parameters are also visible, used to set the activation value of the forced operation and the action of the forced operation.

-- Parameter "Forced operation on object value "

This parameter sets the value of the message used to activate the forced operation. Options:

0=Force/1=Cancel

1=Force/0=Cancel

0=Force/1=Cancel: When the object "Forced operation" receives the message value "0", the forced operation is activated. When "1" is received, the forced operation is canceled.

1=Force/0=Cancel: When the object "Forced operation" receives the message value "1", the forced operation is activated. When "0" is received, the forced operation is canceled.

-- **Parameter "Behaviour on Forced operation "**

This parameter defines how the fan behaves when a forced operation is performed. Options:

Unchange

OFF

ON

Unchange: The fan speed of the fan remains unchanged

OFF: Turn off the fan;

ON: Turn on the fan.

The forced operation has the second highest priority, but is also affected by the minimum run time and delay switch set by the parameters below.

Parameter "Auto. operation function "

This parameter is used to enable automatic operation of the fan.

When it is enabled, the parameter interface 4.8.1.1 is visible. At the same time, the following parameters will also affect the actions of automatic operation, such as delay switch and minimum running time.

Parameter "Time mode for function ON"

This parameter defines the run time of the fan. Options:

None

Switch delay

Minimum time

None: Execute immediately after receiving the control command of the blower;;

Switch delay: Delayed opening of the fan, ON action after reset, will also be delayed to open, the delay time is set by the following parameter "Delay time [1...65535]". If the fan object "Fan speed" receives the message "1" multiple times in succession, the delay time is timed according to the actual situation, instead of counting from the last received message time;

Note: The ON action after resetting also needs to consider this delay time. After the delay is completed, turn on the fan.

Minimum time: The minimum running time of the fan can only be turned off after this running time has elapsed. The minimum running time is set by the parameter "Minimum time [1...65535]". If a message to turn off the fan is received during the minimum running time, then it is necessary to wait until the period has passed before the action of turning off the fan is performed.

-- Parameter "Delay time [1..65535]"

This parameter defines the time at which the fan is turned on after a delay.

Options: **1...65535 *0.1s**

-- Parameter "Minimum time [1..65535]"

This parameter defines the minimum run time after the fan is turned on. Options: **1...65535 s**

Parameter "Time mode for function OFF"

This parameter defines the off time of the fan. Options:

None

Switch delay

Minimum time

None: Execute immediately after receiving the control command to turn off the fan;

Switch delay: Delay off the fan, the OFF action after reset, will also be turned off after the delay, the delay time is set by the following parameter "Delay time [1...65535] * 0.1s";

Minimum time: The wind is removed for the shortest time. Only after this time can the fan be turned on again. The minimum closing time is set by the parameter "Minimum time[1...65535]s". If a message of the blower is received during the shortest off time, then it is necessary to wait until the period has passed before the blower is executed. Note that the OFF action after reset is also the shortest time to consider.

-- Parameter "Delay time [1..65535]"

This parameter defines the time for the fan to be turned off. Options: **1...65535 *0.1s**

-- Parameter "Minimum time [1..65535]"

This parameter defines the minimum time that the fan is off. Options: **1...65535 s**

4.8.1.1. Parameter window "Fx: Auto."

When the parameter "Auto. operation function" is enabled in Figure 4.8.1, the interface for automatic operation is visible. The interface of Figure 4.8.1.1 is used to set the automatic operation of level 1 fan speed, and the threshold can be defined. Automatically, the control value of the fan speed comes from the bus, and one control value or two control values can be set in the function parameters. For example, in the fan coil control system, only heating or cooling, at this time, the fan control only needs to set a control value. If there is heating in the system and there is cooling, then the fan control setting two control values will be more appropriate.

Normal operation and automatic operation cannot occur at the same time, that is, after the automatic operation is activated by the object "Automatic function", if there are other operations (such as normal operation, forced operation, manual operation), the automatic operation will exit by itself, and the object "Automatic function" is required. Activated again, the object "Status Automatic" reports whether the automatic operating status is active.

--- Multifunctional Actuator with Secure, 4-Fold > Channel function > Fan 1-... > F1: Auto

KNX Secure	Auto.operation on object value	<input type="radio"/> 0=Auto/1=Cancel <input checked="" type="radio"/> 1=Auto/0=Cancel
General setting	State of Auto.operation after startup	<input checked="" type="checkbox"/>
Channel function	Automatically enable auto.operation	<input checked="" type="checkbox"/>
Fan 1-...	Enable auto.operation after[10...6000]	100 min
F1: Auto	Threshold value OFF<->ON[1..100]	30 %
F1: Status	Hysteresis threshold value in +/-[0..50]	10 %
Output 3-...	Number of control value	<input type="radio"/> 1 <input checked="" type="radio"/> 2
Output 4-...	Select by	<input type="radio"/> Latest value <input checked="" type="radio"/> Control value with switching object
	Monitoring control value	<input checked="" type="checkbox"/>
	Monitoring period of control value [10...65535]	120 s
	Reply mode of Obj."Control value fault"	<input type="radio"/> Respond after read only <input checked="" type="radio"/> Respond after change
	Control value after fault occurs [0...100]	0 %

Fig. 4.8.1.1 Parameter window "Fx: Auto."

Parameter "Auto. Operation on object value"

This parameter sets the value of the message used to activate the automatic operation.

Options:

0=Auto/1=Cancel

1=Auto/0=Cancel

0=Auto/1=Cancel: When the object "Automatic function" receives the telegram value "0", it activates the automatic operation. When it receives "1", it exits the automatic operation;

1=Auto/0=Cancel: When the object "Automatic function" receives the telegram value "1", it activates the automatic operation. When it receives "0", it exits the automatic operation.

Parameter "State of Auto. operation after startup"

This parameter sets whether automatic operation is enabled when the device starts up.

When it is disabled, after the device is started, the automatic operation is disabled by default.

When it is enabled, after the device is started, the automatic operation is enabled by default.

Parameter "Automatically enable auto. operation"

This parameter sets whether the auto-enable feature of automatic operation is enabled.

When it is enabled, when enabled, the next parameter is visible.

When the normal operation exits the automatic operation, in the absence of any operation, the automatic setting returns to the automatic operation after the time set by the next parameter is reached.

-- Parameter "Enable auto. Operation after [10..6000]"

This parameter sets the time from automatic return to automatic operation from normal operation. Options: **10..6000 min**

Parameter "Threshold value OFF<->ON [1...100]"

This parameter defines the threshold. The fan can automatically change its operating state according to the threshold range in which the control value is located. The control value is determined by the object "Control value". Options: **1...100 %**

If the control value is greater than or equal to the threshold set by the parameter, the fan is turned on;

If the control value is less than this threshold, the fan is turned off.

Parameter "Hysteresis threshold value in +/- [0..50]"

This parameter sets the hysteresis value of the threshold. The hysteresis can avoid unnecessary action of the fan when the control value fluctuates near the threshold.

Options: **0 ... 50 %**

If it is 0, there is no hysteresis. Once the control value crosses the threshold, the fan will switch immediately;

Assuming a lag value of 10 and a threshold of 50, there will be an upper threshold of 60 (threshold + lag value) and a lower threshold of 40 (threshold - lag value), then when the control value is between 40 and 60, it will not cause The action of the fan still maintains its previous state.

Only less than 40 will turn off the fan, and more than or equal to 60 will turn on the fan as shown below:

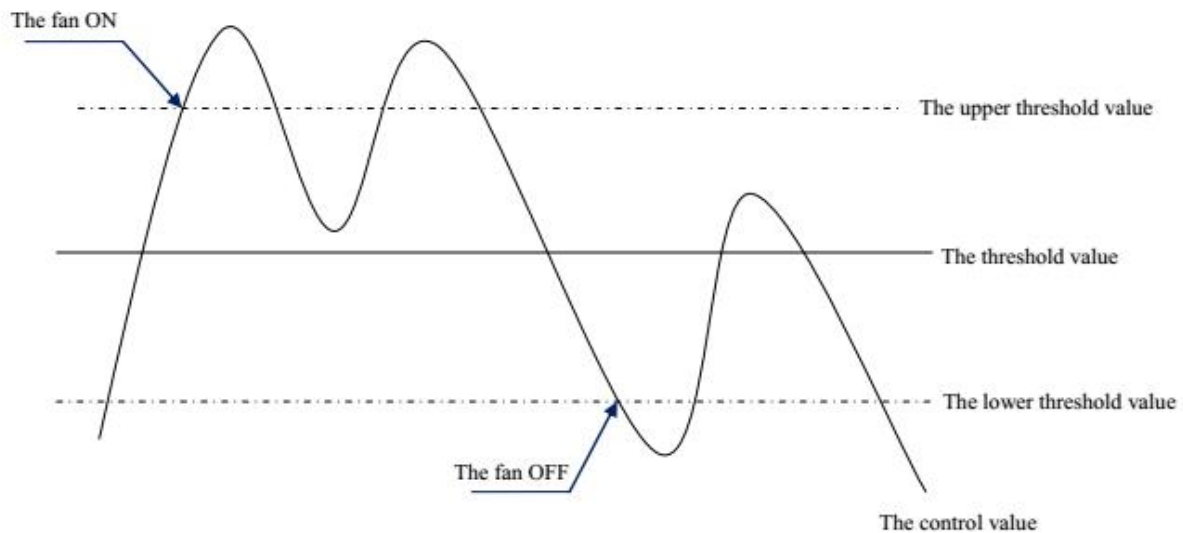

The following parameters in this subsection are descriptions of fan speed control values.

Parameter "Number of control value"

To set the number of automatic fan speed control values. Options:

1

2

1 control value: Only one control value can control the fan speed. Generally suitable for only heating, cooling, or 2 pipes fan coil control systems;

2 control values: There are two control values to control the fan speed. It is usually used in fan coil control systems that support both heating and cooling.

Parameter "Select by"

This parameter is visible when 2 control values are selected in the previous parameter, it is used to set the switching mode of the control value. Options:

Latest value**Control value with switching object**

Latest value: The fan coil actuator will control the fan speed based on the latest control value received from the bus;

Control value with switching object: After selecting this option, the object "Switching control value1/2" is visible to switch the control value of fan speed, message 0 corresponds to control value 1, and message 1 corresponds to control value 2.

Note: When this option is selected, after the automatic operation is activated, it is necessary to enable the control value to be 1 or 2 first, then the received control value is valid. It does not respond to the received control value until it is clarified. The value received by the object "Switching control value1/2" is also logged when the automatic operation is not activated.

After the automatic operation exits, the (valid) control value received from the bus will be recorded. After the automatic operation is activated again, the fan speed will be operated according to the latest control value or fault control value. The effective control value refers to the currently selected control value. If it is control value 1, then control value 2 is invalid.

Parameter "Monitoring control value"

To set whether to enable monitoring of external control values.

When it is enabled, the following parameters are visible.

-- Parameter "Monitoring period of control value[10..65535]"

To set the monitoring period of external control value. If the control value is not received within this time, the device will consider the external controller error and the fan coil will output according to the control value set by the next parameter. Options: **10...65535 s**

--Parameter "Reply mode of Obj. "Control value fault""

To define the feedback method when the external control value is incorrect. Options:

Respond after read only**Respond after change**

Respond after read only: The object "Control value fault" sends the current state to the bus only when the device receives the read status from other bus device or bus.

Respond after change: When the fault status changes or the device receives a request to read the status, the object "Control value fault" immediately sends a message to the bus to report the current status.

-- Parameter "Control value after fault occurs [0..100]"

When an error occurs in the external controller, the fan coil will output the fan speed according to the control value set by this parameter. Options: **0...100 %**

4.8.1.2. Parameter window "Fx: Status"

The parameter window "Fx: Status" setting interface is shown in Figure 4.8.1.2. This interface is used to set the status information of the fan operation.

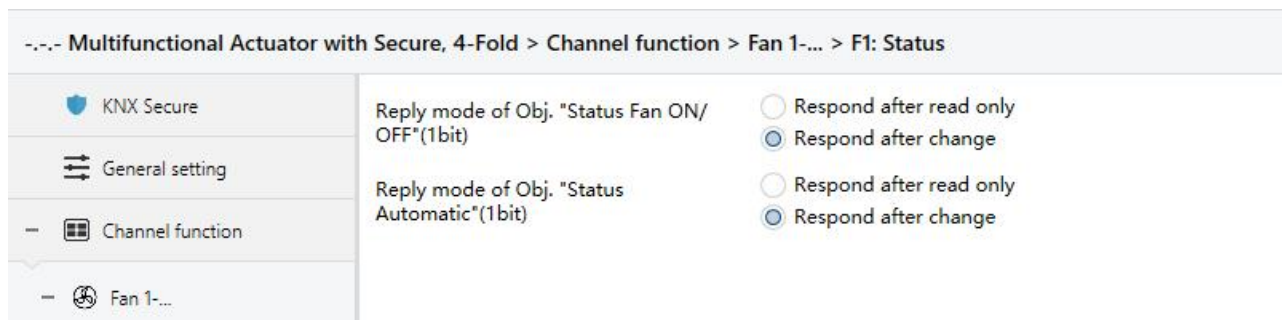

Fig. 4.8.1.2 Parameter window "Fx: Status"

Parameter "Reply mode of Obj. "Status Fan ON/OFF" (1bit)"

To define reply mode for the fan's operating status. Options:

Respond after read only

Respond after change

Respond after read only: The object "Status Fan ON/OFF" sends the current state to the bus only when the device receives the read status from other bus device or bus.

Respond after change: When the fan coil operation status changes or the device receives a request to read the status, the object "Status Fan ON/OFF" immediately sends a message to the bus to report the current status.

Parameter "Reply mode of Obj. "status Automatic" (1bit)"

This parameter is visible when the automatic operation is enabled, and defines the reply mode of the automatic operation status.

The object "Status Automatic" sends a message "1" to indicate that the automatic operation is activated, and "0" to indicate that the automatic operation is exited. Options:

Respond after read only

Respond after change

Respond after read only: The object "Status Automatic" sends the current state to the bus only when the device receives the read status from other bus device or bus.

Respond after change: When the automatic operation status changes or the device receives a request to read the status, the object "Status Automatic" immediately sends a message to the bus to report the current status.

4.8.2. Parameter window “Fan type -- Multi-level”

The parameter window “Fan type -- Multi-level” setting interface is shown in Figure 4.8.2. The parameter settings are as follows:

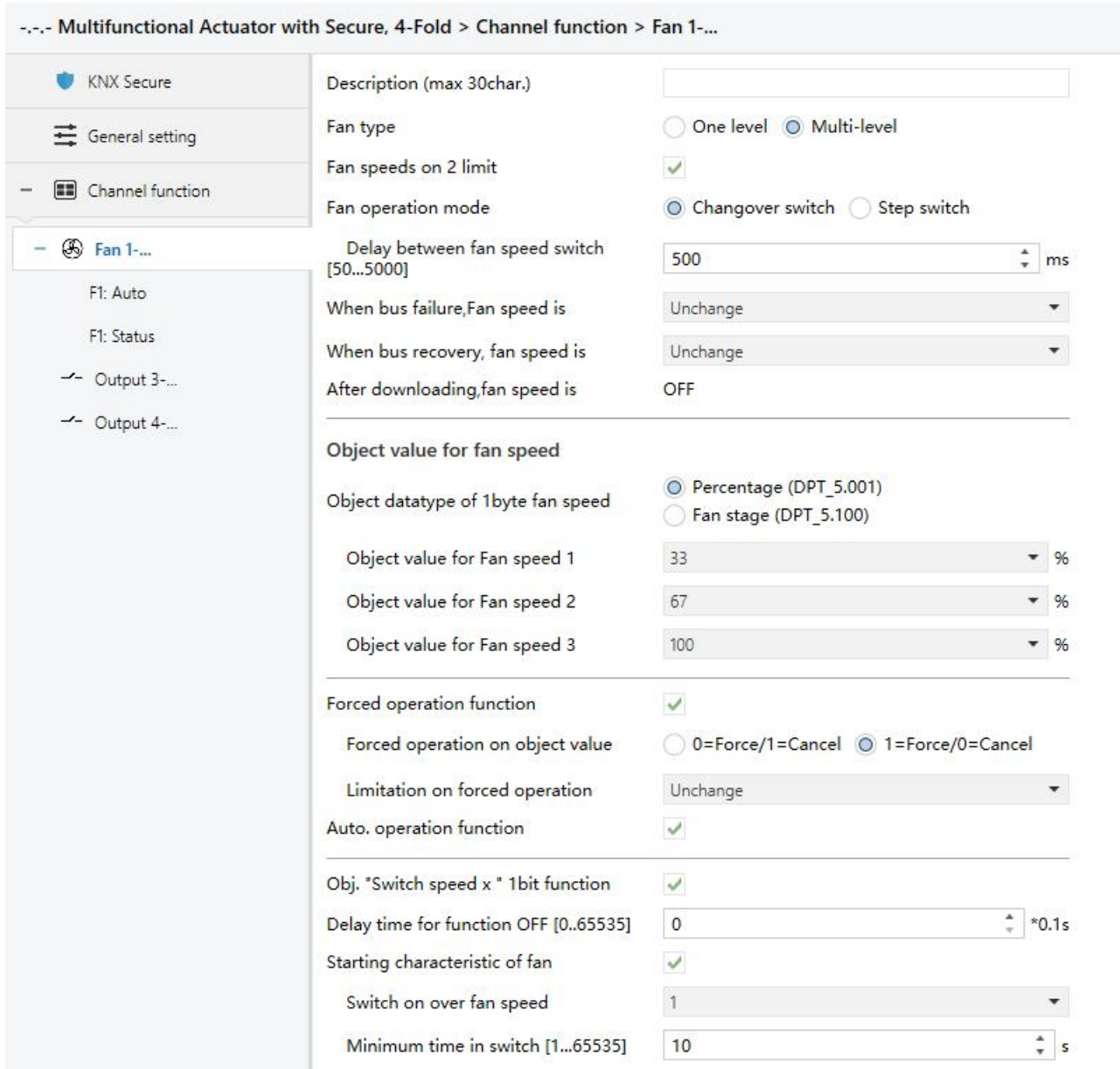

Fig. 4.8.2 Parameter window “Fan type - Multi-level”

The fan coil parameters of 2 level fan speed and 3 level fan speed are the same. When the fan speed is set to 3, the output fan speed is the same as 2.

Since there is no fan with only 1 fan speed as described in the previous section, there is no need to consider too many technical parameters. In the case of multiple fan speeds, not only the starting characteristics of the fan but also the operating mode of the fan like changeover switch or

step switch etc. must be considered. Only when you know the technical characteristics of the fan, the parameters can be properly set.

Parameter "Description (max. 30char.)"

This parameter is used to set the custom description of channel, up to input 30 characters.

Parameter "Fan speeds on 2 limit"

This parameter is only visible when the fan type is selected as "Multi level". It is used to determine whether to enable the 2 level fan speed or the 3 level fan speed.

When it is disabled, fan can control three level fan speeds;

When it is enabled, the fan can control 2 level fan speed, the maximum fan speed can only reach 2, even if the parameter sets the 3 level fan speed. The communication object of fan speed 3 will be ignored.

Note: When the fan speed is limited to level 2, if the fan speed after power failure or reset is set to 3, it will not be executed, that is, the current state will be maintained.

Parameter "Fan operation mode"

This parameter defines the operating mode of the fan and needs to be considered in conjunction with the technical characteristics of the fan. Options:

Changeover switch

Step switch

Changeover switch: It can set the delay time of fan speed changeover, see next parameter. This type of control can switch the fan speed to any level, such as directly switching from the first level fan speed to the third stage fan speed, but in any case, the three channels have only one output.

Step switch: Under this control type, the 3rd-level fan speed is equivalent to the superposition of three one-level fan speeds. For example, when the 3rd-level fan speed is used, all three channels output simultaneously (such as Output 1&2&3). When the 2nd-level fan speed is used, 2 channels output at the same time (such as Output 1&2).

Note: This parameter must be considered in conjunction with the technical parameters of the fan.

-- Parameter "Delay between fan speed switchover[50...5000]"

This parameter is visible when the operating mode is selected as “Changeover switch” and is used to define the conversion delay, which is a specific element of the fan and should be considered in all cases. Available options: **50...5000 ms**

When a fan speed converted telegram is received, the target fan speed will be performed after the delay has elapsed.

If the device receives a new fan speed during the switching delay, the delay time will not be interrupted, but the last received fan speed is executed.

Parameter “When bus failure, Fan speed is”

This parameter notes the action of the fan when the bus is powered down. Options:

Unchange

OFF

1

2

3

OFF: Turn off the fan;

1, 2 or 3: The fan is turned on to fan speed 1, 2 or 3.

Note: If the fan speed is limited to 2, while the parameter selects 3, the fan speed after power failure will maintain the fan speed before power failure.

Parameter “When bus recovery, fan speed is”

This parameter defines the action of the fan after the bus voltage is recovered. Options:

Unchange

OFF

1

2

3

As before as bus fail

OFF: Turn off the fan.

1, 2 or 3: The fan is turned on to fan speed 1, 2 or 3.

As before as bus fail: The fan speed is the same as the speed before the bus is powered down.

Note: Before connecting the fan, in order to obtain a defined fan switch status, it is recommended to connect the bus voltage first to avoid the possibility of damage to the fan due to incorrect connections. If the parameter 3 is selected in the case of limiting the 2nd fan speed, the fan speed after the reset does not change.

Parameter "After downloading, fan speed is"

This parameter indicates to turn off the fan after the application is programmed.

Object value for fan speed

Parameter "Object datatype of 1byte fan speed"

This parameter is used for setting the object datatype of 1byte fan speed. Options:

Percentage (DPT_5.001)

Fan stage (DPT_5.100)

Parameter "Object value for Fan speed 1/2/3"

To define the object value to switch to each fan speed, that is, the value of the communication object "Fan speed-1byte". Options: **1..255 or 1..100 %**

The object value "0" defaults to fan speed off.

Note: the fan speed value must meet the condition fan speed $1 < 2 < 3$, if not, they can not be configured on ETS.

Parameter "Forced operation function"

To enable forced operation.

When it is enabled, the 1-bit communication object "Forced Operation" is visible, and the following two parameters are also visible. It is used to set the activation value of the forced operation and the action that can be performed under the forced operation.

-- Parameter "Forced operation on object value "

To set the telegram value to activate the forced operation. Options:

0=Force/1=Cancel

1=Force/0=Cancel

0=Force/1=Cancel: When the object "Forced Operation" receives the message value "0", the forced operation is activated. When "1" is received, the forced operation is cancelled.

1=Force/0=Cancel: When the object "Forced Operation" receives the message value "1", it

activates the forced operation. When it receives "0", it cancels the forced operation.

Note: During forced operation, the minimum operating time of fan speed for automatic operation still needs to be considered, except for the starting fan speed, as it has its own minimum running time.

Forced operation is not activated by default after bus reset or after programming.

-- **Parameter "Limitation on forced operation "**

To define the limitation fan speed under forced operation. Options:

Unchange

1

1, off

2

2, 1

2, 1, off

3

3, 2

3, 2, 1

Off

Unchange: The fan speed of the fan remains unchanged and maintains the current operating state;

1: Only fan speed 1 is operated;

1, off: Only fan speed 1 and shut down the fan can be operated;

2: Only fan speed 2 can be operated;

2, 1: Only fan speeds 1 and 2 can be operated;

2, 1, off: Only fan speed 1, 2 and shut down the fan can be operated;

3: Only fan speed 3 can be operated;

3, 2: Only fan speed 3, 2 can be operated;

3, 2, 1: Only fan speed 1, 2 and 3 can be operated;

Off: Only shut down the fan can be operated;

Note: In the case of forced operation activation, if the current fan speed is not within the

allowable range, the fan speed will switch to the nearest allowable current fan speed. For example, the current fan speed is 1, and the allowed fan speed is 2 3, then when the forced operation is activated, the fan speed will automatically switch to 2, if the fan speed is adjusted to 1 by manual mode, the running fan speed will also be 2.

In another case, if the current fan speed is 0, the allowed fan speed is 1, 2, 3, and the starting fan speed is 3. When the forced operation is activated, the fan starts at fan speed 3 and then automatically switches to fan speed 1; if the current fan speed is 2, the allowed fan speed is 1, 2, when a forced operation is activated, a fan speed 0 message is received, then the fan speed will switch to 1. In this case, the fan speed switches to the fan speed near the target fan speed.

Parameter "Auto. operation function"

This parameter is used to enable automatic operation of the fan.

When it is enabled, the parameter interface 4.8.2.1 will be visible.

Parameter "Obj. Switch speed x 1bit function"

This parameter is used to enable object of 1bit fan speed.

When it is enabled, three 1-bit objects "Fan speed 1", "Fan speed 2" and "Fan speed 3" are visible.

When the object receives the telegram "1", the fan speed is turned on. When any object of the three objects receives the telegram "0", the fan is turned off.

If three objects continuously receive multiple ON/OFF telegrams in a short time, the fan speed will be controlled with the telegram value received by the last object.

Note: In normal operation mode, the minimum dwell time set by the parameter in automatic mode is ignored. Therefore, the response of the direct operation can be detected in time.

In order to protect the fan, the delay time of the fan speed switching is still valid. At the same time, when the forced operation is activated, it is necessary to consider the fan speed that can be operated under the force operation.

Parameter "Delay time for function OFF[0...65535]"

This parameter defines the delay off time of the fan. For example, if the fan speed of the current fan is speed1 and the control telegram of the fan OFF is received, and the fan will maintain the current fan speed and start the delay counting. After the time defined by the parameter, the OFF operation will be executed.

Options: 0...65535 *0.1s

Note: When the fan is running in automatic mode, this parameter is evaluated and executed only if the parameter "Minimum time in fan speed [0...65535]" is 0.

Parameter "Starting characteristic of fan"

This parameter defines the starting characteristics of the fan, which is also a technical feature of the fan. Usually to ensure the safe start of the fan motor, it is better to start the fan motor at a higher fan speed when the fan is turned on, so that the fan motor obtains a higher torque during the starting phase. For example, the fans and floor fans used in our lives are usually started from the second-stage fan speed when the fan is turned on, and then switched to the minimum fan speed. Some fans start up similarly.

When it is enabled, the following two parameters are visible.

Note: Since the startup feature is a technical feature of the fan, so the startup behavior has a higher priority than the forced operation.

If the fan itself has no starting characteristics, you can ignore the parameters related to the characteristic, just select "No".

For example, the starting fan speed is 3, the fan speed allowed for the forced operation is 2, and is currently in the OFF state. When a control telegram with a fan speed of 1 is received, the fan will be turned on at fan speed 3 and then turned to fan speed 2. The needed fan speed 1 will not run due to mandatory operating restrictions.

For the step switch type of fan, the starting characteristics are different. The step switch type fan is usually the continuous opening fan speed, and the changeover switch type fan is the direct opening fan speed. Therefore, when defining the parameters of the start-up characteristics, it is also necessary to consider the switch type of the fan.

The minimum dwell time for fan speed switching in automatic mode is only considered after the start-up phase, which is inactive during the start-up phase. The minimum dwell time for the fan speed on during the start-up phase can be set additionally, see the parameters below.

-- Parameter "Switch on over fan speed"

This parameter sets the fan speed used by the fan when starts from the OFF state.

Options: 1/2/3

When controlling the fan with 2-level fan speed, if the starting fan speed is set 3, the fan

speed 2 is automatically applied.

However, in order to ensure the normal operation of the fan, when setting these parameters related to the characteristics of the fan, it is best to first understand these characteristics, and then set the parameters properly to avoid damage to the fan.

-- Parameter "Minimum time in switch[1..65535]"

This parameter defines the minimum dwell time at which a certain fan speed is turned on during the start-up phase. Options: **1...65535 s**

When the fan is turned on, it starts at the starting fan speed first, and then switch to the target fan speed after the minimum dwell time expires. This target fan speed may be the fan speed of the fan after resetting or the fan speed triggered by other operations.

During the start-up phase, the delay time between the two fan speeds must also be considered.

Example: Starting characteristics of a fan with 3 fan speeds

Assume that the current state of the fan is off, the starting fan speed is level 3, the target fan speed is level 1, and the final fan speed is level 2, as shown in the following figure:

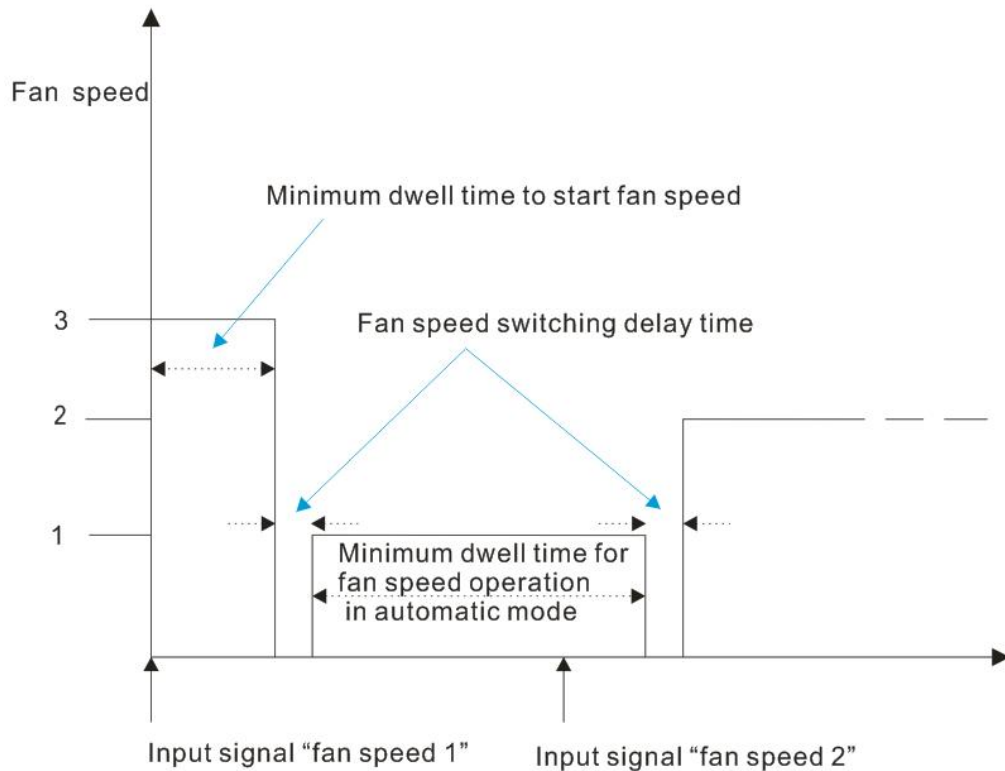

The above figure shows that if the fan is currently in the off state, when it receives a telegram of "Fan Speed 1", it will start "Fan Speed 3". After the minimum stay time of the start fan speed is over, it switches the fan speed. The fan speed switching needs a delay time (this is a technical parameter of the fan, which is conducive to protect the fan), After the delay time expires, the fan switches to the target fan speed "fan speed 1", in the "fan speed 1" operation, if the fan receives a "fan speed 2" telegram, then you need to consider whether the automatic mode is activated. If the automatic mode is activated, you need to consider the minimum dwell time of the fan speed operation. If it is direct operation, you do not need to consider dwell time of the fan speed operation. After the delay time has elapsed, the fan runs at "Fan Speed 2".

4.8.2.1. Parameter window "Fx: Auto."

When the parameter "Auto. operation function" in Figure 4.8.2 is enabled, the parameter interface of Figure 4.8.2.1 is visible.

This interface is used to set the automatic operation of multi-level fan speed, and the threshold can be defined. Under automatic operation, the fan speed control value comes from the bus, and the fan speed is determined according to the threshold range in which the control value is located.

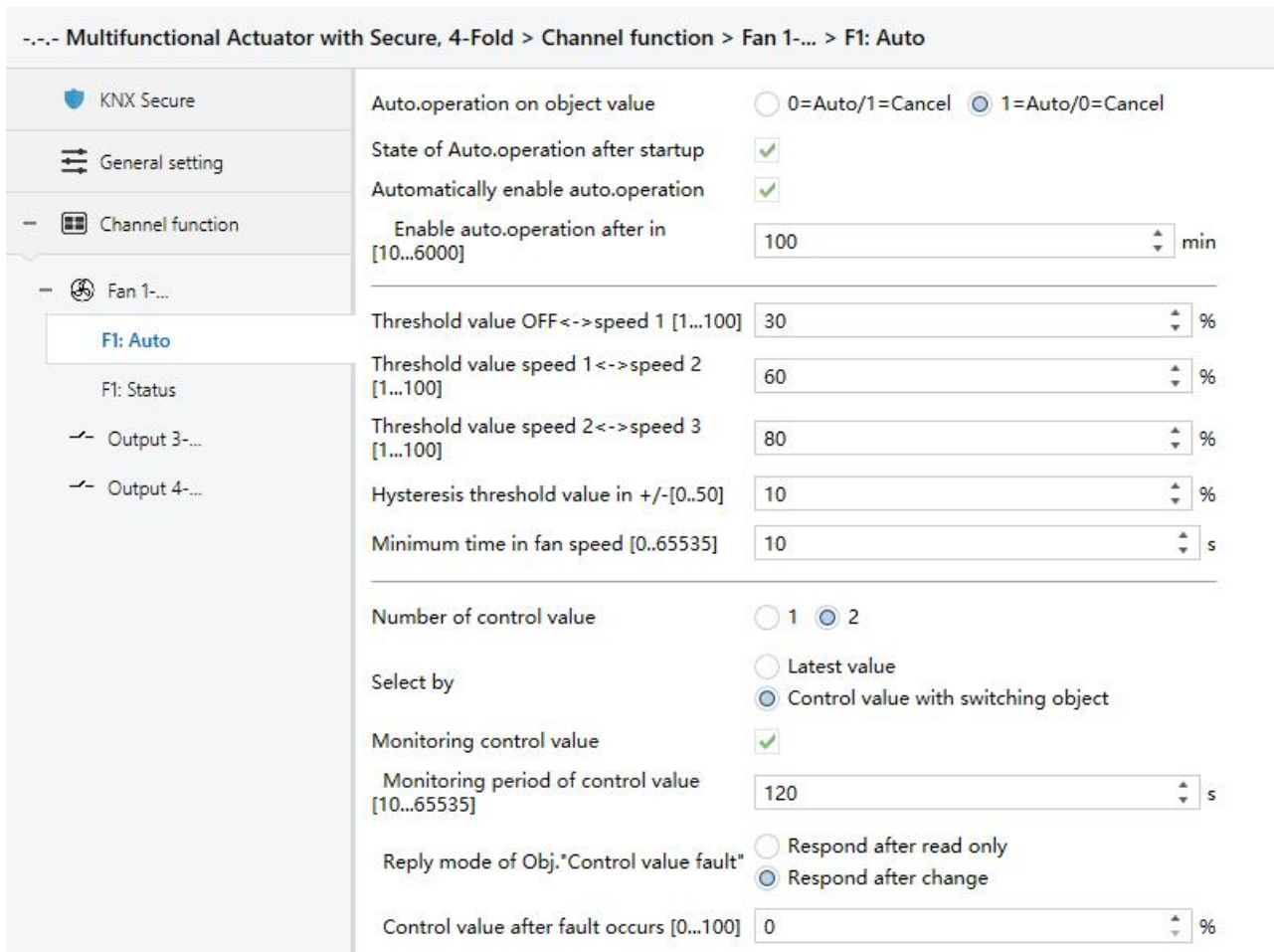

Fig. 4.8.2.1 Parameter window "Fx: Auto."

Parameter "Auto. operation on object value"

This parameter sets the value of the telegram used to activate the automatic operation.

Options:

0=Auto/1=Cancel

1=Auto/0=Cancel

0=Auto/1=Cancel: When the object "Fan Automatic ON/OFF" receives the telegram value "0", the automatic operation is activated. When "1" is received, the automatic operation is canceled.

1=Auto/0=Cancel: When the object "Fan Automatic ON/OFF" receives the telegram value "1", the automatic operation is activated. When "0" is received, the automatic operation is canceled.

Parameter "State of Auto. operation after startup"

This parameter sets whether automatic operation is enabled when the device starts up.

When it is disabled, after the device is started, the automatic operation is disabled by default.

When it is enabled, after the device is started, the automatic operation is enabled by default.

Parameter "Automatically enable auto. operation"

This parameter sets whether the auto-enable feature of automatic operation is enabled.

When it is enabled, the next parameter is visible.

When the normal operation exits the automatic operation, in the absence of any operation, the fan returns to the automatic operation after the time set by the next parameter is reached.

Parameter "Enable auto. Operation after [10..6000]"

This parameter sets the time when returns to automatic operation from normal operation.

Options: **10..6000 min**

Parameter "Threshold value OFF<-->speed 1 [1...100]"

This parameter defines the threshold for turning off the fan and speed 1, options: **1...100 %**

If the control value is larger than or equal to the threshold set by the parameter, the running speed 1;

If the control value is less than this threshold, the fan is turned off.

Note: The fan determines the switch or fan speed of the fan based on the threshold range in which the control value is located. The following two parameters are similar.

Parameter "Threshold value speed 1<-->speed 2 [1...100]"

This parameter defines the threshold for switching the fan speed to speed 2, and if the control value is greater than or equal to the threshold set by the parameter, then speed 2 is operated. Options: **1...100 %**

Parameter "Threshold value speed 2<->speed 3 [1...100]"

This parameter defines the threshold for switching the fan speed to speed 3, and if the control value is greater than or equal to the threshold set by the parameter, then speed 3 is operated. Options: **1...100 %**

Note: The controller evaluates these thresholds in ascending order, that is, first checks the threshold of OFF <-> fan speed 1, then fan speed 1 <-> fan speed 2, then fan speed 2 <-> fan speed 3.

The correctness of function execution is only guaranteed in this case: OFF <-> fan speed 1 threshold is less than fan speed 1 <-> fan speed 2 threshold, fan speed 1 <-> fan speed 2 threshold is less than fan speed 2 <-> fan speed 3 threshold. If this condition is not met, parameters in ETS cannot be configured:

Threshold value OFF<->speed 1 [1...100]	<input type="text" value="30"/>	%
Threshold value speed 1 <-> speed 2 [1...100]	<input type="text" value="80"/>	%
Threshold value speed 2 <-> speed 3 [1...100]	<input type="text" value="80"/>	%

Parameter "Hysteresis threshold value in +/- [0...50]"

This parameter sets the hysteresis value of the threshold. The hysteresis can avoid unnecessary action of the fan when the control value fluctuates near the threshold. Available options: **0...50 %**

If it is 0, there is no hysteresis. Once the control value is greater than the threshold, the fan will switch the fan speed immediately;

Assuming a lag value of 10 and a threshold of 50, there will be an upper threshold of 60 (threshold + lag value) and a lower threshold of 40 (threshold - lag value), then when the control value is between 40 and 60, it will not cause the action of the fan and still maintains its previous state.

Only less than 40 or greater than (or equal to) 60 will change the operating state of the fan. As shown below:

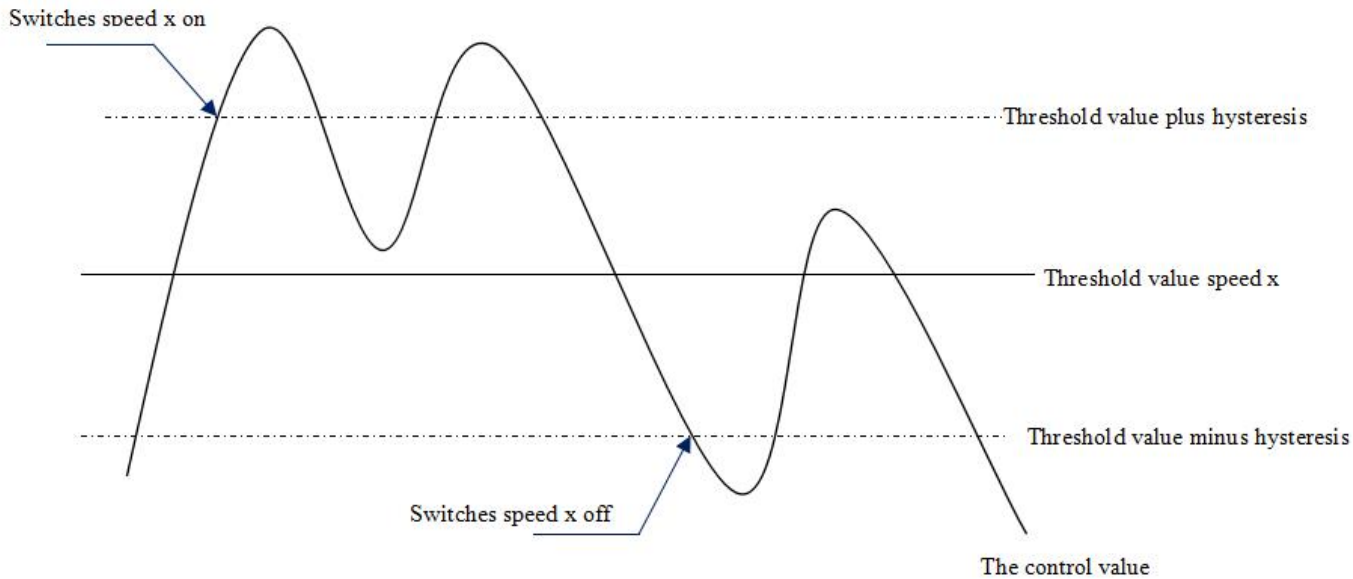
**Note:**

In the case of hysteresis enabled, if threshold overlap occurs, the action of the fan is specified as follows:

- 1) The hysteresis determines the control point at which the fan speed transition occurs;
- 2) If the fan speed transition occurs, this new fan speed is determined by the control value and the threshold, without considering the hysteresis;

For example (1):

OFF \leftrightarrow fan speed 1 threshold is 10%

Fan speed 1 \leftrightarrow fan speed 2 threshold is 20%

Fan speed 2 \leftrightarrow fan speed 3 threshold is 30%

Lag is 15%

The behavior of the fan when the fan speed rises from OFF:

The fan's OFF state will change at a control value of 25% ($\geq 10\% + 15\%$), and the new fan speed will be 2 (because 25% is between 20% and 30%, no need to consider hysteresis), so fan speed 1 is ignored ;

The behavior of the fan when the fan speed drops from 3:

The fan speed 3 of the fan will change at a control value of 14% ($< 30\% - 15\%$), and the new fan speed will be 1 (because 14% is between 10% and 20%, no need to consider hysteresis), so

fan speed 2 is ignored. .

For example (2):

OFF <-> fan speed 1 threshold is 10%

Fan speed 1 <-> fan speed 2 threshold is 40%

Fan speed 2 <-> fan speed 3 threshold is 70%

Lag is 5%

The behavior of the fan when the fan speed rises from OFF:

The OFF state of the fan will change at a control value of 15% ($\geq 10\% + 5\%$).

If the received control value is 41%, the new fan speed will be 2 (because 41% is between 40% and 70%, no need to consider hysteresis), so fan speed 1 is ignored;

If the control value received is 39%, the new fan speed will be 1 (since 39% is between 10% and 40%, no need to consider hysteresis).

The behavior of the fan when the fan speed drops from 3:

The fan speed 3 of the fan will change at a control value of 64% ($< 70\% - 5\%$).

If the received control value is 39%, the new fan speed will be 1 (because 39% is between 10% and 40%, no need to consider hysteresis), so fan speed 2 is ignored.

3) In any case, when the control value is 0, the fan will be turned off.

Parameter "Minimum time in fan speed [0...65535]"

This parameter defines the dwell time before the fan switches from the current fan speed to a higher fan speed or a lower fan speed, that is, the minimum time for a fan speed operation.

If you want to switch to another fan speed, you need to wait for this period of time before switching. If the current fan speed has been running for a long enough time, the fan speed can be switched quickly. Available options: **0...65535 s**

0: means no delay switching.

Note:

The dwell time set by this parameter is only enabled in automatic mode.

The minimum running time is required for each fan speed (including off) in the automatic mode, and the fan speed under automatic operation is changed step by step.

For example, if the current fan speed is 1, and the target fan speed is 3, then the fan speed

will first change from 1 to 2, then to 3, and each fan speed operation will change after the minimum running time.

Starting the fan speed does not need to consider the minimum running time, since the starting fan speed has its own minimum running time.

If the minimum time is set to 0, switch to the target fan speed directly, the fan speed will no longer change step by step.

The description of the fan speed control value is not described in this chapter. For details, please refer to section 4.8.1.1.

4.8.2.2. Parameter window "Fx: Status"

The parameter window "Fx: Status" setting interface is shown in Figure 4.8.2.2. This interface is used to set the running status information of the fan with multi-level fan speed.

Fig. 4.8.2.2 Parameter window "Fx: Status"

Parameter "Reply mode of Obj. "Status Fan ON/OFF"(1bit)"

This parameter defines the reply mode of the fan switch status. Options:

Respond after read only

Respond after change

Respond after read only: The object "Status Fan ON/OFF" sends the current state of the fan to the bus only when the device receives the read fan ON/OFF status from other bus device or bus.

Respond after change: When the fan on/off status changes or the device receives a request to read the status, the object "Status Fan ON/OFF" immediately sends a telegram to the bus to report the current status.

Parameter "Reply mode of Obj. "Status Automatic" (1bit)"

This parameter is visible when the automatic operation is enabled, and defines the reply mode of the automatic operation status.

The object "Status Automatic" sends a telegram "1" to indicate that the automatic operation is activated, and the telegram "0" to indicate that the automatic operation is canceled. Options:

Respond after read only

Respond after change

Respond after read only: The object "Status Automatic" sends the current state of automatic operation to the bus only when the device receives the read status from other bus device or bus.

Respond after change: When the automatic operation status changes or the device receives a request to read the status, the object "Status Automatic" immediately sends a telegram to the bus to report the current status.

Parameter "Reply mode of Obj. "status fan speed x" (1bit)"

This parameter defines the reply method for the fan speed status. Three 1-bit objects "Status Fan speed 1", "Status Fan speed 2" and "Status Fan speed 3" are used to reply the status of each level of fan speed. Options:

Respond after read only

Respond after change

Respond after read only: The object sends the current state to the bus only when the device receives the read status from other bus device or bus.

Respond after change: When the status changes or the device receives a request to read the status, the object immediately sends a telegram to the bus to report the current status.

Parameter "Reply mode of Obj. "Status fan speed" (1byte)"

This parameter sets the reply mode of the current running fan speed state. The object is "Status fan speed" and is of 1 byte type. The status value of each stage fan speed output is defined by the next parameter. Options:

Respond after read only**Respond after change**

Respond after read only: The object sends the current state to the bus only when the device receives the read status from other bus device or bus.

Respond after change: When the status changes or the device receives a request to read the status, the object immediately sends a telegram to the bus to report the current status.

Status feedback for fan speed**Parameter "Status value for Fan speed 1/2/3"**

This parameter sets the status feedback value for each fan speed. Options: **1..255** or **1..100 %**, the state value of OFF is specified as 0.

Fan speed 1<2<3, if this condition is not met, parameters in ETS cannot be configured.

4.8.3. Explanation of priority

The priority for various operations of fan control:

Initialization(After the parameter download is completed)→Manual operation (Long press the manual button to switch to manual operation, and the button of the channel has operation)→General or automatic operation

Apply to the following points:

1. Manual operation is mainly used for on-site emergency or debugging, so technical features of fan, such as starting fan speed, delay/minimum running time, conversion time, etc. are not considered, but the response is directly output.

2. Manual operation will make automatic operation exit, automatic operation can be activated again via its object after manual operation is exited. If it is one-level fan, force operation will also make automatic operation exit, multi-level fans only limit the fan speed within the allowable range.

3. During manual operation, forced command received will be recorded, and the control value of automatic operation will also be recorded.

4.9. Valve Control

The valve control is divided into Heating, Cooling, 2 pipes system and 4 pipes system, their parameter setting are similar, just the output channels they occupied are different. Up to 2 switch outputs are occupied by Heating/Cooling/2-pipe while 4 switch outputs are occupied by 4 pipes system. Therefore, up to 12 output can be set for Heating/Cooling /2-pipe, and up to 6 outputs can be set for 4 pipes system.

Valve type can be set in the parameter interface"Channel function", as shown in Fig. 4.9(1); parameter setting interface of Heating/Cooling/2-pipe as shown in Fig. 4.9(2)~(4); parameter setting interface of 4 pipes system as shown in Fig. 4.9(5). Parameters of different valve type are similar and are described in the following.



Fig. 4.9(1) Parameter window Channel function--valve type”

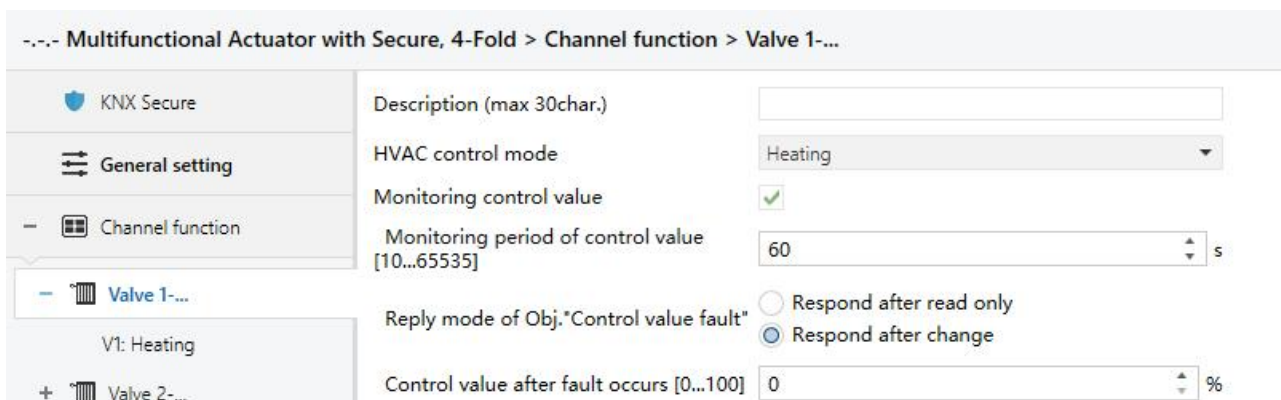

Fig. 4.9(2) Parameter window “Valve X General--Heating”

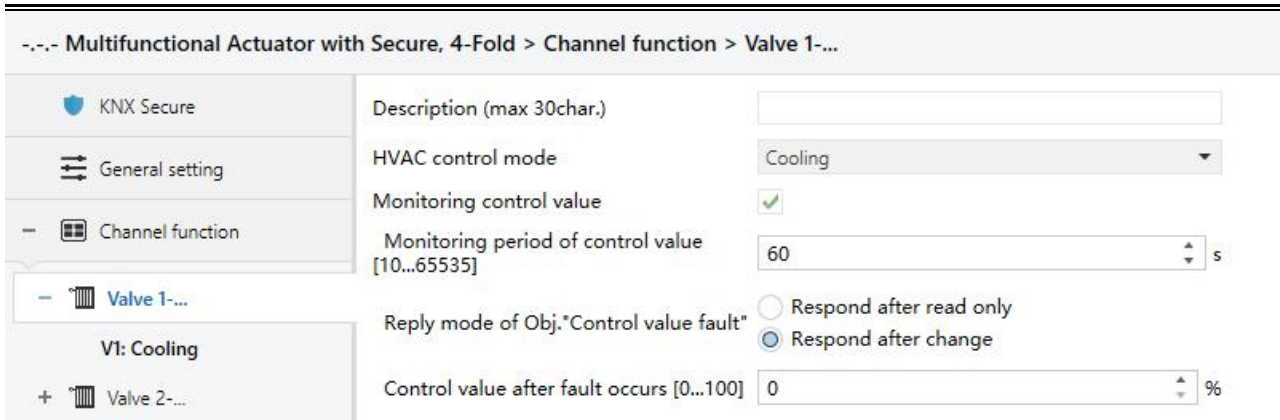

Fig.4.9(3) Parameter window “Valve X General–Cooling”

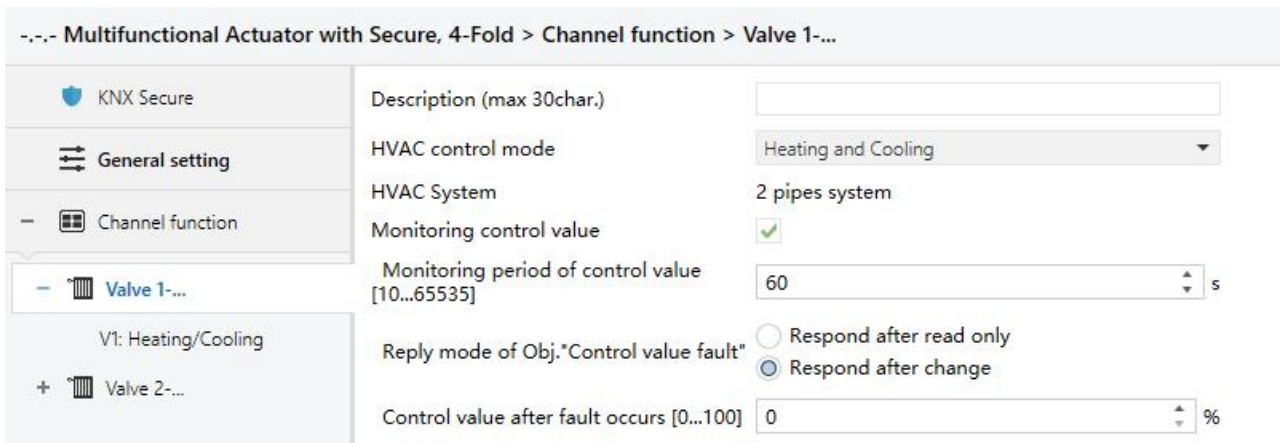

Fig. 4.9(4) Parameter window “Valve X General–Heating and Cooling (2-pipes)”

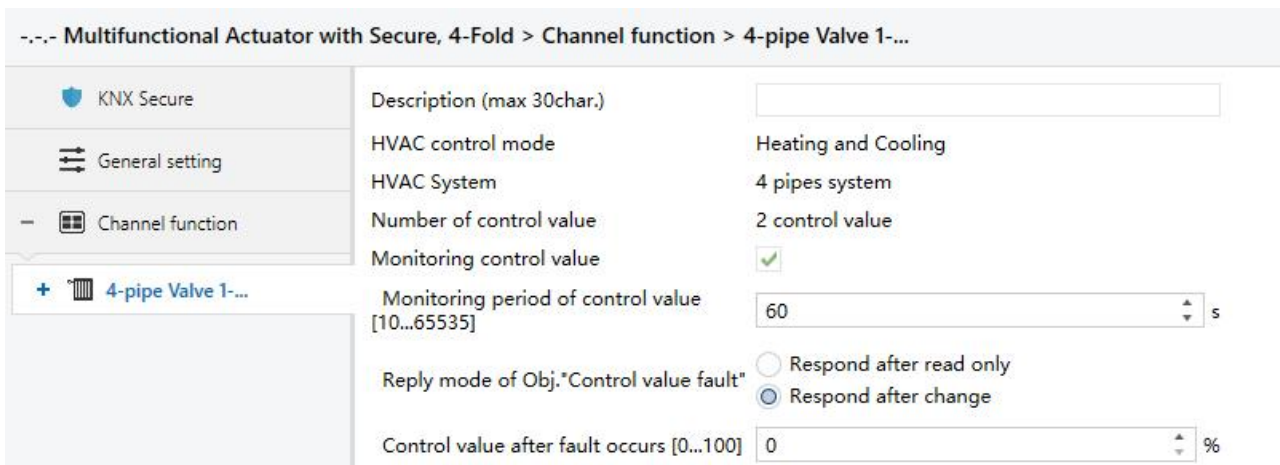

Fig. 4.9(5) Parameter window “4-Pipe Valve X General–Heating and Cooling (4-pipes)”

Parameter “Description (max. 30char.)”

This parameter is used to set the custom description of channel, up to input 30 characters.

Parameter “HVAC Control mode”

This parameter is used to set the HVAC control mode. Options are:

Heating

Cooling

Heating and Cooling

Heating: The fan coil can only achieve heating function;

Cooling: The fan coil can only achieve cooling function;

Heating and cooling: The fan coil can achieve both heating and cooling function.

Parameter "HVAC System"

This parameter is visible when select 2 pipes or 4 pipes system, for indicating HVAC system, i.e. the type of pipe in which the fan coil enters and exits the water.

2 pipes system: Two-pipe system, using one inlet and outlet pipe for heating and cooling, that is, hot water and cold water share a valve control;

4 pipes system: Four-pipe system, which has its own inlet and outlet pipes for heating and cooling, and requires two valves to control the ingress and egress of hot and cold water.

Parameter "Number of control value"

This parameter is visible when select "Valve control (4-pipe)". It is used to indicate that there are two control values under 4 pipes system, one for controlling the heating valve and the other controlling the cooling valve.

Parameter "Monitoring control value"

This parameter sets whether to enable monitoring the control value.

When it is enabled, the following parameters are visible.

-- Parameter "Monitoring period of control value[10..65535]"

This parameter sets the time period for monitoring the control value. If the control value has not been received within this time, the device will consider the external controller error and the valve will output according to the control value set by the next parameter.

Available options: **10..65535 s**

-- Parameter "Reply mode of Obj. "Control value fault""

This parameter defines the reply mode when the external control value is incorrect. Options:

Respond after read only

Respond after change

Respond after read only: The object "Control value fault" sends the current state to the bus only when the device receives the read status from other bus device or bus.

Respond after change: When the status changes or the device receives a request to read the status, the object "Control value fault" immediately sends a message to the bus to report the current status.

-- Parameter "Control value after fault occurs [0..100]"

When an error occurs in the external controller, the device will output the valve according to the control value set by this parameter. Options: 0...100 %

The following is a supplementary description of the piping system (this product is suitable for 2 and 4 pipe systems):

In daily life, the fan coil system can be divided into 2-pipe, 3-pipe and 4-pipe systems according to the inlet and outlet pipes of hot and cold water.

The 2-pipe system is a set of inlet and outlet water systems for cold/hot water. When the water pipes are cold water, they are cooling. When the water pipes are hot water, they are heating. Therefore, cooling and heating cannot be performed at the same time.

2-pipe system wiring: only one valve is needed to control the flow of hot or cold water.

In many applications, two-tube systems are mostly used for cooling, and heating needs to be achieved by other commonly used heaters.

The 2-pipe system is somewhat similar. The 3-pipe system has separate pipe input system for each of the cold/hot water pipes, but shares one pipe output, so heating and cooling cannot be performed simultaneously.

The 4-pipe system has two inlet and outlet systems that provide both cold and hot water.

However, there is a single-pole single-switch in the fan, and only one can be applied at the same time for heating and cooling.

The wiring method of the 4-pipe system: the valve is connected to the cooling/heating valve connection output end of the device to control the flow of the hot and cold water.

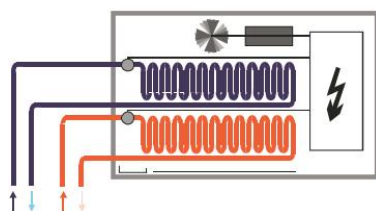

4-pipe fan coil

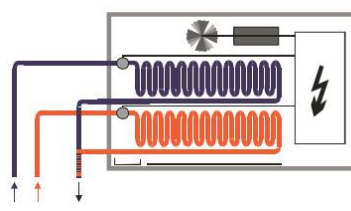

3-pipe fan coil

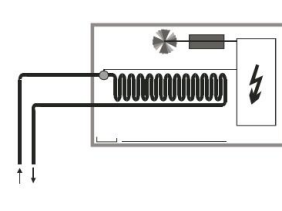

2-pipe fan coil

4.9.1. Parameter window “Vx: Heating/Cooling”

The parameter window “Vx:Heating” and “Vx: Cooling” setting interface are shown in Figures 4.9.1(1) and 4.9.1(2). These two interfaces are mainly used to set the control mode and related parameters of the heating and cooling valve. Different valve types are applicable to different control modes. Therefore, when setting the control mode, it needs to be considered in combination with the valve type.(Control modes and parameters of the valve under both 2 pipes and 4 pipes system are similar, here no longer explain.)

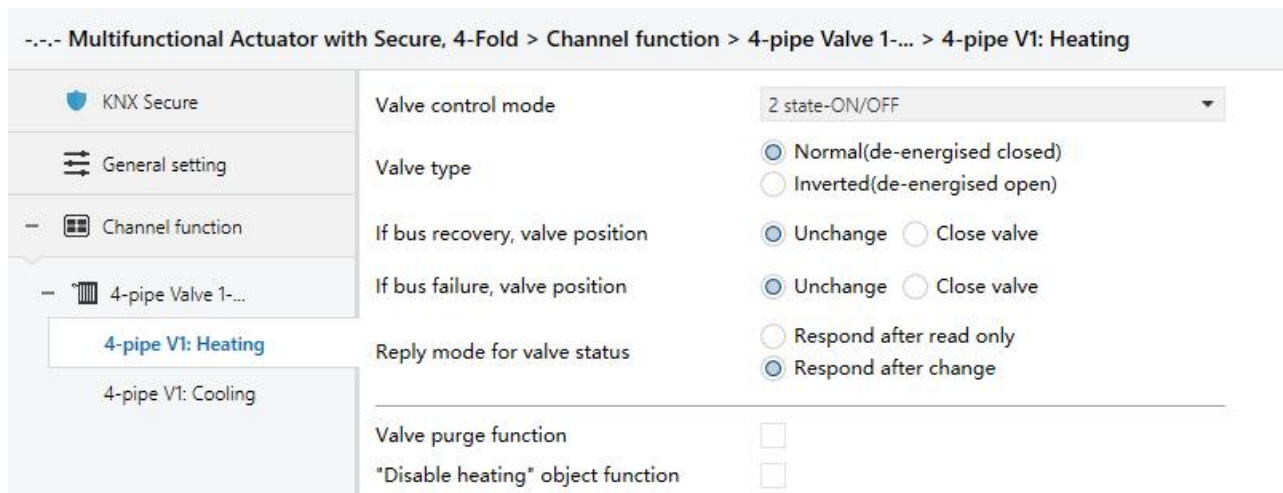

Fig. 4.9.1(1) Parameter window “Vx: Heating”

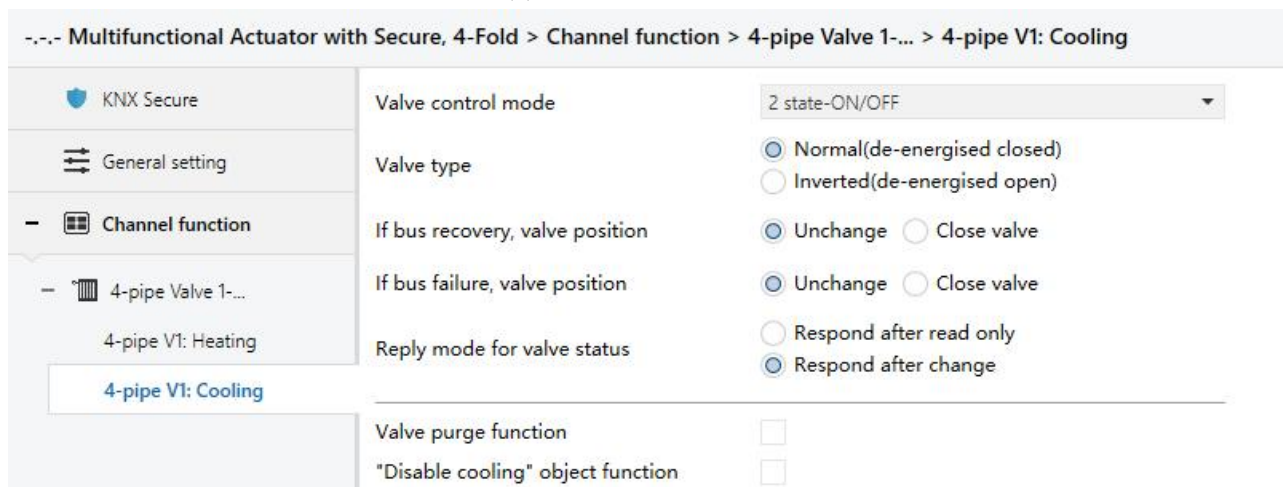

Fig. 4.9.1(2) Parameter window “Vx: Cooling”

Parameter “Valve control mode”

This parameter is used to set the type of valve to be controlled. Options:

- 2 state-ON/OFF**
- Continuous, PWM**
- 3 point, open and close**

2 state-ON/OFF: Two-point switch control mode, suitable for ordinary on-off valve, the valve is based on the received switch control value switch output;

Continuous, PWM: PWM continuous control mode, the valve performs periodic switching output according to the control value received by the object.;

3 point, open and close: The control type is suitable for driving three-wire valves, and the valve opening is controlled according to the control value of the valve.

The following takes the heating valve parameter interface as an example to illustrate the parameter settings of three different modes, and the cooling valve is similar.

4.9.1.1. 2 state-ON/OFF

The parameter setting interface is shown in Figure 4.9.1.1.

--- Multifunctional Actuator with Secure, 4-Fold > Channel function > 4-pipe Valve 1-... > 4-pipe VI: Heating

KNX Secure	Valve control mode	2 state-ON/OFF
General setting	Valve type	<input checked="" type="radio"/> Normal(de-energised closed) <input type="radio"/> Inverted(de-energised open)
Channel function	If bus recovery, valve position	<input checked="" type="radio"/> Unchange <input type="radio"/> Close valve
4-pipe Valve 1-...	If bus failure, valve position	<input checked="" type="radio"/> Unchange <input type="radio"/> Close valve
4-pipe VI: Heating	Reply mode for valve status	<input type="radio"/> Respond after read only <input checked="" type="radio"/> Respond after change
4-pipe VI: Cooling	Valve purge function	<input checked="" type="checkbox"/>
	Duration of valve purge time [1...255]	10 min
	Automatic valve purge	<input checked="" type="checkbox"/>
	Purge Cycle in weeks [1...12]	1
	Reply mode for valve purge status(1bit)	<input type="radio"/> Respond after read only <input checked="" type="radio"/> Respond after change
	Disable heating object function	<input checked="" type="checkbox"/>
	Trigger object value	<input checked="" type="radio"/> 0=Disable/1=Enable <input type="radio"/> 1=Disable/0=Enable

Fig. 4.9.1.1 Parameter window "2 state-ON/OFF"

Parameter "Valve type"

This parameter sets the direction of the valve switch. Options:

Normal(de-energised closed)

Inverted(de-energised open)

For on-off valves, "Normal (de-energised closed)" is suitable for normally closed switching valves, and "Inverted (de-energised open)" is suitable for always opening switching valves.

Parameter "If bus recovery, valve position"

This parameter sets the position of the valve after the bus voltage is reset. Options:

Unchange

Close valve

Unchange: After the bus voltage is powered down, the valve status remains unchanged.;

Close valve: Valve closed.

Parameter "If bus failure, valve position"

This parameter sets the position of the valve after the bus voltage is powered down. Options:

Unchange

Close valve

Unchange: After the bus voltage is powered down, the valve status remains unchanged.;

Close valve: valve closed.

Note: After the application programming , the valve status is off by default.

Parameter "Reply mode for valve status(1bit)"

This parameter defines how the valve status responds. Options:

Respond after read only

Respond after change

Respond after read only: The object "Valve status, Heat/Cool" sends the current status to the bus only when the device receives a status read from another bus device or bus.

Respond after change: When the status changes or the device receives a request to read the status, the object "Valve status, Heat/Cool" immediately sends a telegram to the bus to report the current status.

Parameter "Valve purge function"

This parameter is used for setting whether to enable valve purge function .

When it is enabled, a 1-bit communication object "Trigger valve purge, Heat/Cool" is visible for triggering the valve cleaning operation while the following parameters are visible.

-- Parameter "Duration of valve purge time[1...255]"

This parameter sets the duration of the valve cleaning. During this time, the valve is fully open. When this time passes, the state before cleaning is re-established. Options: **1...255 min**

If the heating/cooling operation is prohibited during the cleaning, the cleaning will continue.

And during the cleaning, the received operation prohibition telegram and the valve control telegram are both recorded, and the value status will be updated according to the new telegrams after the cleaning is completed.

-- Parameter "Automatic valve purge"

Visible when the valve cleaning function is enabled.

Used to enable automatic valve cleaning function, the following parameters can be seen.

-- Parameter "Purge Cycle in weeks[1...12]"

This parameter defines the period of automatic valve cleaning. In weeks, the time starts from the power-on of the device, and the cleaning operation is triggered after timing.

Once the cleaning is completed, the time is reset, whether it is done by automatic cleaning or by object-triggered cleaning, which is reset. Options: **1...12**

Note: The manual operation has the highest priority and the cleaning priority is the second highest. If the cleaning time has not expired, the cleaning process is manually interrupted. At the end of this cleaning, the manual exit will not continue the last cleaning.

-- Parameter "Reply mode for valve purge status (1bit)"

This parameter is visible when the valve cleaning function is enabled and defines the feedback mode for the valve cleaning status. Options:

Respond after read only

Respond after change

Respond after read only: The object "Valve purge status, Heat/Cool" sends the current status to the bus only when the device receives a status read from another bus device or bus;

Respond after change: When the status changes or the device receives a request to read the status, the object "Valve purge status, Heat/Cool" immediately sends a message to the bus to report the current status.

Parameter "Disable heating/cooling" object function"

This parameter is used for setting whether to enable disable function .

When it is enabled, a 1-bit communication object "Disable, Heat/Cool" is visible and can be used to disable heating/cooling operations while the following parameters are visible.

-- Parameter "Trigger object value"

This parameter sets the value of the message used to disable the heating/cooling operation.

Options:

0=Disable/1=Enable

1=Disable/0=Enable

0=Disable/1=Enable: When the object "Disable, Heat/Cool" receives the message value "0", the heating/cooling operation is prohibited, and when "1" is received, it is reactivated;

1=Disable/0=Enable: When the object "Disable, Heat/Cool" receives the message value "1", the heating/cooling operation is prohibited, and when "0" is received, it is reactivated.

Note: When the operation is disabled, the valve position is immediately adjusted back to the off state. When enabled again, the valve state will be updated according to the current control value. During the prohibition period, the received telegram is recorded, and fault monitoring still continues.

The cleaning function and the function of prohibiting the valve control are similar in each control mode. The following two control modes will not be repeated.

4.9.1.2. Continuous, PWM

The parameter setting interface is shown in Figure 4.9.1.2.

--- Multifunctional Actuator with Secure, 4-Fold > Channel function > 4-pipe Valve 1-... > 4-pipe V1: Heating

KNX Secure	Valve control mode	Continuous,PWM
General setting	Valve type	<input checked="" type="radio"/> Normal(de-energised closed) <input type="radio"/> Inverted(de-energised open)
Channel function	PWM cycle time [10..6000]	120 s
4-pipe Valve 1-...	If bus recovery, valve position	<input checked="" type="radio"/> Unchange <input type="radio"/> Close valve
4-pipe V1: Heating	If bus failure, valve position	<input checked="" type="radio"/> Unchange <input type="radio"/> Close valve
4-pipe V1: Cooling	Reply mode for valve status	<input type="radio"/> Respond after read only <input checked="" type="radio"/> Respond after change
	Valve purge function	<input checked="" type="checkbox"/>
	Duration of valve purge time [1...255]	10 min
	Automatic valve purge	<input checked="" type="checkbox"/>
	Purge Cycle in weeks [1...12]	1
	Reply mode for valve purge status(1bit)	<input type="radio"/> Respond after read only <input checked="" type="radio"/> Respond after change
	"Disable heating" object function	<input checked="" type="checkbox"/>
	Trigger object value	<input checked="" type="radio"/> 0=Disable/1=Enable <input type="radio"/> 1=Disable/0=Enable

Fig. 4.9.1.2 Parameter window "Continuous, PWM"

This control mode is suitable for driving two-wire valves.

This control mode has only two states "fully open" and "completely closed". The valve performs cyclic switching operation according to the control value and PWM cycle. For example, the control value is 20%, the PWM period is 15min, then the valve will open for 3min, close for 12min, control When the value is 60%, then the valve will open for 9min, off for 6min, the control value is evaluated by the temperature controller or sensor device to the current temperature and set temperature, and then sent to the device. The valve adjustment diagram is as follows:

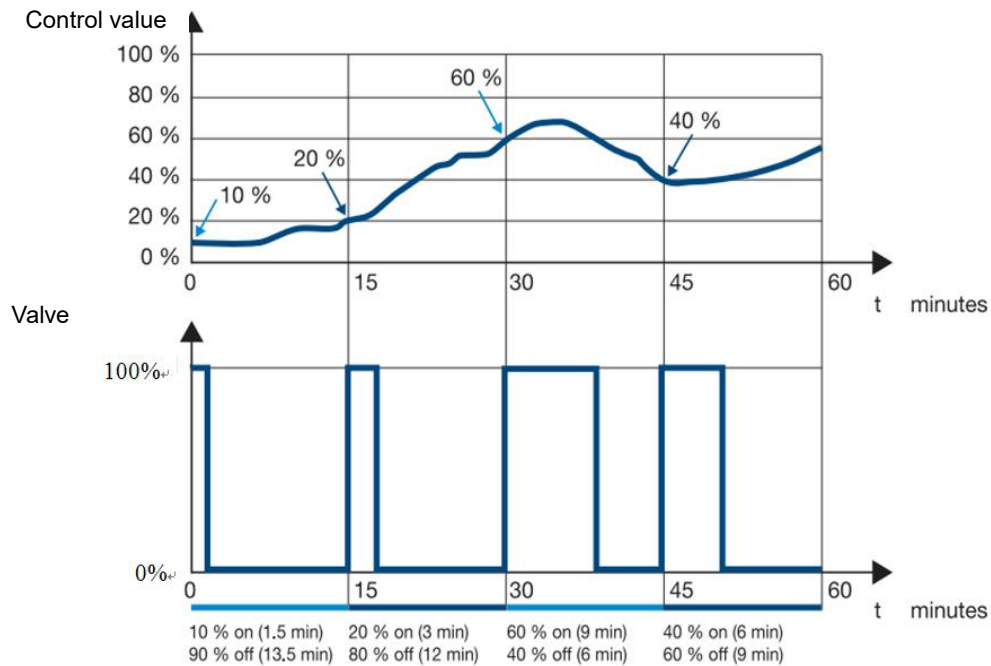

This control mode enables relatively accurate temperature control without temperature overshoot. Simple, low-cost control valves can be used. For example, it can be used in conjunction with an electric valve actuator. The switching frequency of the control valve is relatively high.

This control mode parameter interface is similar to "2state-ON/OFF", and the description of the same parameters will not be repeated here. The difference is that the PWM switching period can be set as follows:

Parameter "PWM cycle time [10..6000]"

This parameter is used to set the time period of PWM control. The larger the value, the smaller the valve switching frequency. Conversely, the smaller the value, the more frequent the valve switch. Options: **10...6000 s**

Note: For Continuous, PWM valves, different switches, status feedback information is as follows:

Valve switch type	Description
Normal (de-energised closed)	When the valve is relayed, the object "Valve status, Heat/Cool" sends the message "0"; when there is current (relay closed), the message "1" is sent.
Inverted (de-energised open)	When the valve has a current (relay closed), the object "Valve status, Heat/Cool" sends a message "0"; when there is no current (relay opened), the message "1" is sent.

4.9.1.3. 3 point, open and close

The parameter setting interface is as shown in Figure 4.9.1.3.

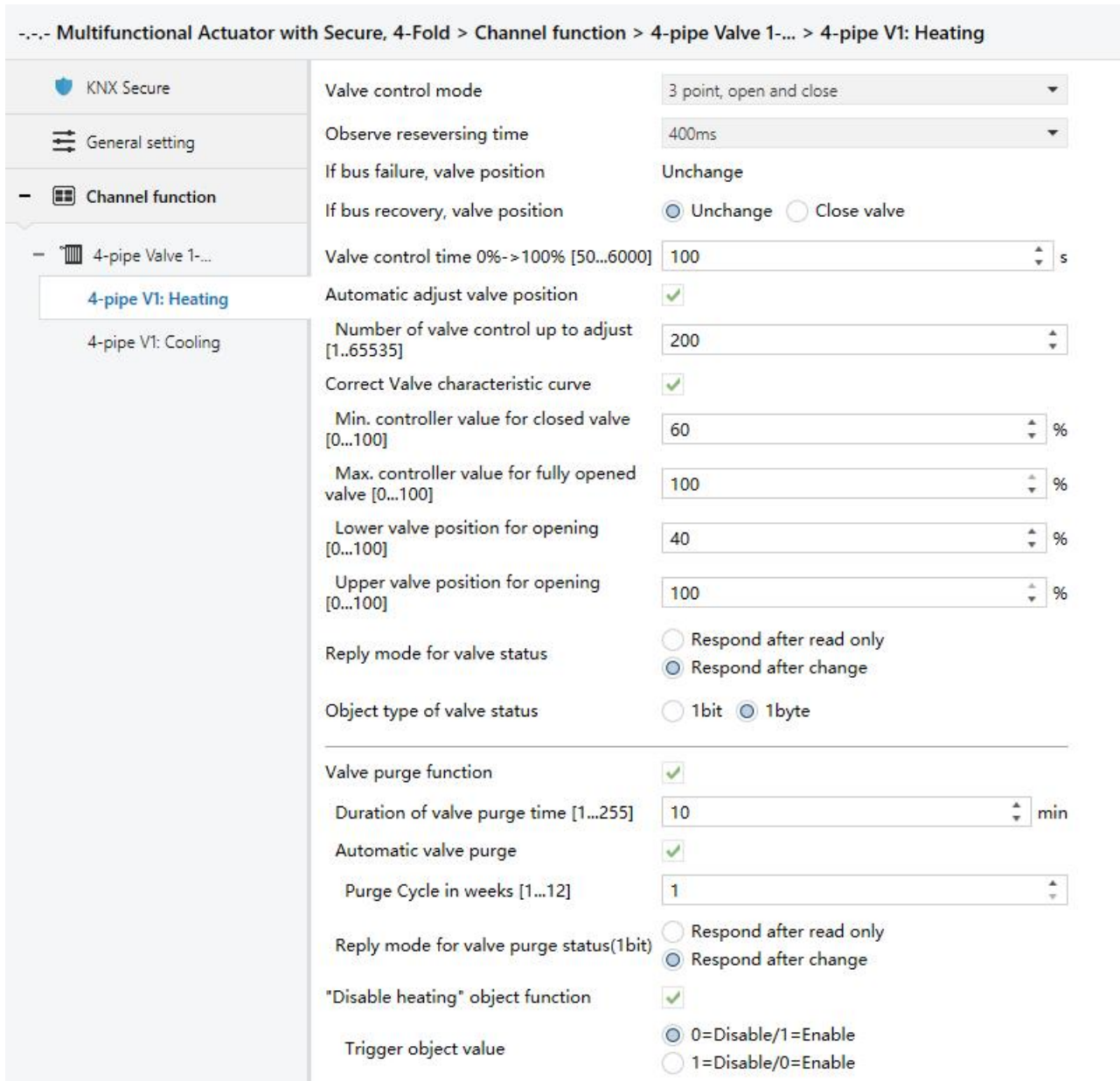
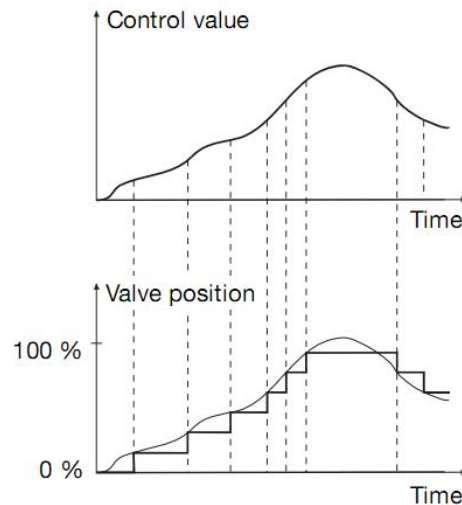

Fig. 4.9.1.3 Parameter window "3 point, open and close"

This control mode is suitable for driving three-wire valves. It controls the opening of the valve according to the control value received by the object. It can realize "completely open", "completely close" or open the valve to a certain position. This control mode is the most accurate. Control method, while the switching frequency of the valve is also very low. For example, if the control value is 20%, then the valve will stop output when it is 20% open. The valve adjustment diagram is as follows:



The parameter functions of this control mode are described below:

Parameter "Observe reversing time"

This parameter sets the time the valve will pause while running the steering, which helps protect the valve. Options:

100ms

200ms

...

1s

1.2s

1.5s

The steering pause time is a technical feature of the valve and should be considered in any operation. When setting this parameter, refer to the technical characteristics of the valve.

Parameter "If bus failure, valve position"

This parameter annotates the state before the valve is held after the system voltage is powered down.

Parameter "If bus recovery, valve position"

This parameter sets the position of the valve after the system voltage is reset. Options:

Unchange

Close valve

Unchange: The default state of power-on after the system voltage is restored.

Close valve: Valve closed.

Note: The parameter download is not processed as a system reset, and the valve position is adjusted to 0%. Only when it is adjusted to 0%, the valve position can be determined and the next step is performed.

In this control mode, the timing of the automatic cleaning function is counted from the position of the valve.

Parameter "Valve control time 0% → 100% [50...6000]"

This parameter sets the time required for the valve to go from fully closed to fully open, the total travel time. Options: **50...6000 s**

Assuming that the travel time set by this parameter is 180s, the current valve position is 20%, and the target position is 60%, then the valve takes 72s from 20% → 60% of the travel time.

The setting of this parameter requires reference to the technical characteristics of the valve.

Parameter "Automatic adjust valve position"

This parameter sets whether the automatic adjustment function of the valve is enabled.

When it is enabled, the following parameters are visible.

The automatic valve adjustment function mainly plays the role of correcting the position of the valve, Because the valve has undergone many adjustments, due to various reasons, such as temperature, aging of the device, etc, There is a phenomenon that the valve cannot be completely closed or fully opened, so it needs to be re-positioned by this function.

-- Parameter "Number of valve control up to adjust[1...65535]"

This parameter sets how many times the valve has been adjusted, and performs an automatic adjustment, that is, the valve position is adjusted to 0%, re-positioning, but only requires a longer travel time. Options: **1...65535**

Assume 100 times, when the valve has been adjusted 100 times, that is, at the 101st adjustment, If the valve is adjusted in the opening direction, no automatic adjustment is made, If the valve is adjusted in the closing direction, an automatic adjustment will be made, Adjust the valve to 0% position and then adjust to the target position. For example, the 100th valve position is 50%, and the 101st is 60%, The valve will not be automatically adjusted until a reverse adjustment command is received; If the 101st is 40%, then the valve is automatically adjusted, running to 0%, and then running to the target position 40%. The time of automatic adjustment is extended by 5% of the total travel time, that is, travel time + total travel time × 5%, The total travel time × 5% must

be less than or equal to 1 min. When it is greater than 1 min, take 1 min.

When the automatic adjustment is performed, the number is counted again. When the valve adjustment stops, the count increases once (The positioning adjustment when the parameter download is completed is not counted in the number of times). In the process of performing automatic adjustment, If the control value is received, it will wait until the automatic adjustment is completed., If there is a higher priority operation, then the high priority operation ends and then execute.

The setting of this parameter requires reference to the technical characteristics of the valve.

Parameter "Correct Valve characteristic curve"

This parameter sets whether the valve characteristic adjustment is enabled.

When it is enabled, the following parameters can be seen.

- parameter "Min. controller value for closed valve [0...100]"
- parameter "Max. controller value for fully opened valve [0...100]"
- parameter "Lower valve position for opening [0...100]"
- parameter "Upper valve position for opening [0...100]"

Characteristic curve for setting the valve output. Options: **0...100 %**

Min. controller value for closed valve: Lower limit control value of valve characteristic curve;

Max. controller value for fully opened valve: Upper limit control value of valve characteristic curve;

Lower valve position for opening: Lower limit of valve position;

Upper valve position for opening: Upper limit of valve position.

Take the valve with the valve interface as the relay as an example, Assuming the lower limit of the control value is set to 10%, the lower limit of the valve is set to 20%, the upper limit of the control value is set to 70%, and the upper limit of the valve is set to 80%, there is an output characteristic curve as shown below:

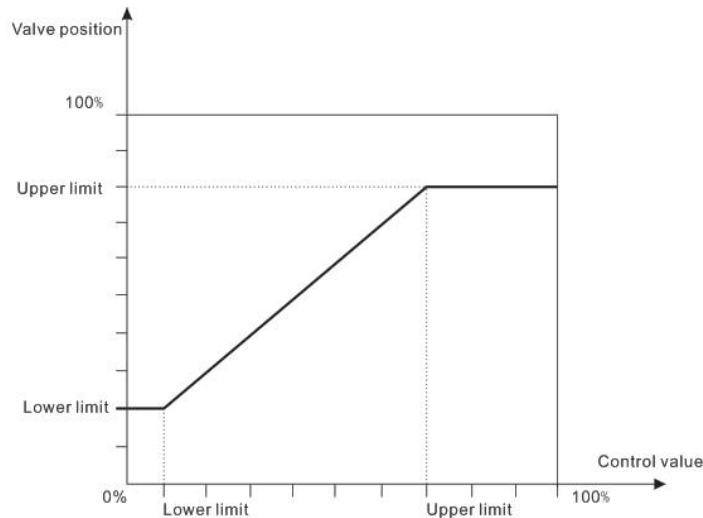

Min. controller value < Max. controller value, if or not, you cannot configure these two parameters in ETS:

Min. controller value for closed valve [0...100] %

Max. controller value for fully opened valve [0...100] %

Lower valve position < Upper lower valve position, if or not, you cannot configure these two parameters in ETS:

Min. controller value for closed valve [0...100] %

Max. controller value for fully opened valve [0...100] %

Parameter "Reply mode for valve status(1bit)"

This parameter defines how the valve status responds. Options:

Respond after read only

Respond after change

Respond after read only: The object "Valve status, Heat/Cool" sends the current status to the bus only when the device receives a status read from another bus device or bus.

Respond after change: When the status changes or the device receives a request to read the status, the object "Valve status, Heat/Cool" immediately sends a message to the bus to report the current status.

Parameter "Object type of valve status"

Set the object type for valve position status feedback. Options:

1bit

1byte

1bit: The next parameter is visible, and a 1-bit object "Valve status, Heat/Cool" is visible for feedback valve switching status.

1byte: A 1byte object "Valve status, Heat/Cool" is visible for feedback valve position status.

-- Parameter "Object value with valve position >0"

Options:

0

1

The option "1", when the valve position is greater than 0, the object "Valve status, Heat/Cool" sends the message "1"; When the valve position is 0, the message "0" is sent. And vice versa.

4.9.2. Explanation of priority

The priority for various operations of valve control:

Initialization(After the parameter download is completed)→Manual operation→Purge function→Automatic adjust valve position(Only 3 point, open and close)→Disable valve operation→Fault monitoring or general operation (Trigger via the object "Control value, Cool/Heat")

Apply to the following points:

1. In the faulty mode, if the valve is disabled, the fault monitoring is still continue and there will also send a fault report to bus, but it can not perform the fault action until there is no higher priority operation. The fault status will be reset only when the control value is received, and at the same time, the monitoring cycle will be restarted.

2. During purging, if a higher priority operation(such as the manual operation) interrupts it, the purging will end, and after exit manual operation the last purging will not continue.

3. Correct valve characteristic curve will correct the control value and the valve position of fault monitoring and general operation.

4. Switch to manual mode, if there is no operation channel button, it will not perform action and continue original action. If current valve is closed, operation button performs valve opening(to upper valve position). If current valve is open, operation button performs valve closing(to 0%). During manual operation, the commands of control value, valve purging and valve disable are ignored, but the fault monitoring will be continue, and the control value can reset the cycle of fault monitoring. After exiting manual operation, it will perform action according to the action of fault status, if no fault, it will maintain until a new control command received.

5. Cool/Heat mode can only be switched by control value and manual operation. Due to the higher priority of purge operation, it is not limited by the control mode, for example, it can trigger the purging of the heat mode in the cool mode, and vice versa. If it is performing the purging of the cool mode currently, it will wait for the purging finished before performing the purging of the heat mode, but the control mode is no change, still in the cool mode. If there receive a control value of another mode during purging, it will switch the status of the control mode immediately, but it need to wait for the purging finished before performing the action according to current control value.

6. In the same control mode, if multiple operations occur within a period of time, it will process according to priority order, that is until high-priority operation to be canceled or end, the low-priority operation can be processed. Assuming currently there are purge function, disable valve operation and control value operation, if cancel the purge operation at the time, it will go back to the valve status of disable operation according to priority order, that is close the valve. If valve is enable again, the valve will tack action according to current control value or fault status.

The following points apply to automatic adjustment of valve position (If enable):

1. If automatic adjustment of valve is interrupted by manual operation or purge function, it will perform again after finishing manual operation and purge function.

2. Automatic adjustment of valve affects disable valve operation, fault action and the action of control value. When valve adjustment times meet the automatic adjustment times, valve travel time will increase, because the valve need to re-position before moving to the target position.

3. Adjustment of valve no matter what the control command(Such as manual operation, purge function, disable valve operation, etc) is to adjust it, when stop the adjustment, the number of adjustments will be increase by one. And it will be reset to 1 after the automatic adjustment is finished.

4. During automatic adjustment of valve operation, if receive new control value, it will wait for the automatic adjustment (Positioning) finished before moving to new target position.

Chapter 5 Communication Object Description

The communication object is the medium through which the device communicates with other devices on the bus, that is, only the communication object can perform bus communication.

The function of each communication object of each function block is described in detail below.

Note: "C" in the property bar of the table below represents the communication function of the communication object;

"W" represents the value of the communication object can be rewritten by the bus;

"R" represents the value of the communication object can be read through the bus;

"T" stands for communication object with transmission function;

"U" means that the value of the communication object can be updated.

5.1. Communication object of General

Number	Name	Object Function	Description	Group Address	Length	C	R	W	T	U	Data Type	Priority
1	General	Central control for all switch			1 bit	C	-	W	-	-	switch	Low
218	General	In operation			1 bit	C	-	-	T	-	switch	Low
531	General	Central control for Up/Down			1 bit	C	-	W	-	-	up/down	Low
532	General	Central control for Slat/Stop			1 bit	C	-	W	-	-	step	Low

Fig. 5.1 Communication object of General

No.	Object function	Name	Type	Flags	DPT
218	In operation	General	1bit	C,T	1.001 DPT_Switch
This communication object is used to periodically send a message "1" to the bus to indicate that the device is functioning properly. This communication object is always enabled.					
1	Central control for all switch	General	1bit	C,W	1.001 DPT_Switch
This communication object is used for centralized control of the switch output. Only the switch output channel with centralized control can be used for centralized control through this object. 0 -- off 1 -- on					
531	Central control for Up/Down	General	1bit	C,W	1.008 DPT_UpDown
This communication object is used for centralized control of the curtain position. Only the curtain output channel that enables centralized control can be centrally controlled by this object. Telegram value: 0-- the blinds move up / the curtains open 1-- the blinds moving down / curtains closed					

532	Central control for Slat/Stop	General	1bit	C,W	1.007 DPT_Step
<p>This communication object is used to stop the curtain movement or adjust the centralized control of the louver angle. Only the curtain output channel with centralized control can be used for centralized control through this object. Telegram value:</p> <p style="margin-left: 40px;">0 --- stop / adjust the louver upwards</p> <p style="margin-left: 40px;">1 --- stop/down adjust louver</p>					

Table 5.1 Communication object table of General

5.2. Communication object of switch output

5.2.1. Communication object of switch actuator

Number	Name	Object Function	Description	Group Address	Length	C	R	W	T	U	Data Type	Priority
2	Output 1-...	Switch			1 bit	C	-	W	-	-	switch	Low
3	Output 1-...	Switch status			1 bit	C	R	-	T	-	switch	Low
4	Output 1-...	Enable time function			1 bit	C	-	W	-	-	enable	Low
5	Output 1-...	Staircase function			1 bit	C	-	W	-	-	switch	Low
6	Output 1-...	Operation hours counter			4 bytes	C	R	W	T	U	time lag (s)	Low
7	Output 1-...	Scene			1 byte	C	-	W	-	-	scene control	Low
8	Output 1-...	Forced output			1 bit	C	-	W	-	-	enable	Low
9	Output 1-...	Logic 1			1 bit	C	-	W	-	-	boolean	Low
10	Output 1-...	Logic 2			1 bit	C	-	W	-	-	boolean	Low

Fig. 5.2.1 Communication object of switch output-switch actuator

No.	Object function	Name	Type	Flags	DPT
2	Switch	Output 1-{{...}}	1bit	C,W	1.001 DPT_Switch
<p>This communication object is used to trigger the switch operation.</p> <p>The name in parentheses changes with the parameter "Description (max.30 char.)". If description is empty, display "Output 1-..." by default. The same below.</p> <p>When "Input 0" in the logic function is enabled, The communication object "switch" is not directly used to trigger the switch operation., the action of the switch will be affected by the logic function. Please refer to the following flow chart for details:</p>					

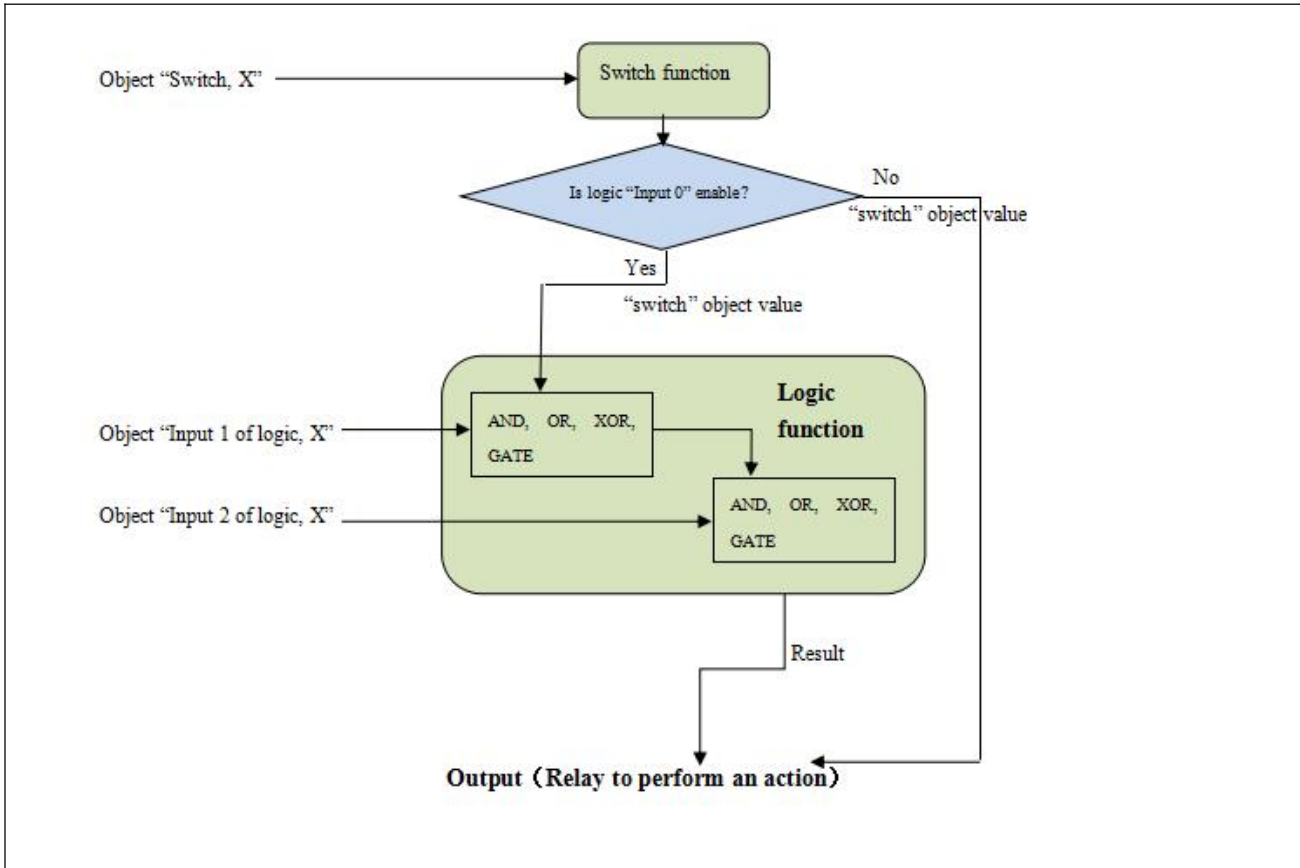

3	Switch status	Output 1-{{...}}	1bit	C,R,T	1.001 DPT_Switch
<p>The value of this communication object (Specifically set in the parameter "Object value of switch status" in Figure 4.4 "Output X") Can directly indicate the status of the relay contacts.</p> <p>If you choose "Respond after read only", only when the device receives a request from the bus to read the status of the channel switch, this object sends the current switch state to the bus;</p> <p>If you choose "Respond after change", when the switching state of the channel changes, This object immediately sends the current switch state to the bus.</p>					
4	Enable time function	Output 1-{{...}}	1bit	C,W	1.003 DPT_Enable
<p>The communication object is enabled when the time function is enabled. Time function can be prohibited by this communication object, When the communication object receives a message with a logical value of "1", the time function is enabled; When the telegram of "0" is received, the time function is disabled, but the operation before the disabling will continue to be completed, and time control command received during disable time is ignored.</p> <p>When the time function is turned on, the time function is enabled by default when the bus resumes power supply.</p>					
5	Delay function	Output 1-{{...}}	1bit	C,W	1.001 DPT_Switch
<p>The communication object is enabled when the parameter "Type of time function" is selected as "Delay", and the delay switch is turned on by this communication object.</p>					

5	Flashing function	Output 1-{{...}}	1bit	C,W	1.001 DPT_Switch																						
The communication object is enabled when "Flashing" is selected in the parameter "Type of time function", and the flashing switch is turned on by this communication object.																											
5	Staircase function	Output 1-{{...}}	1bit	C,W	1.001 DPT_Switch																						
The communication object is enabled when the parameter "Type of time function" is selected as "Staircase", and the stair light function is activated by this communication object.																											
6	Operation hours counter	Output 1-{{...}}	2byte 4byte	C,R,W,T,U	7.007 DPT_TimePeriodHrs 13.100 DPT_LongDeltaTimeSec																						
This communication object is used to report the time when the load of this loop is powered on, Displayed when the parameter "Function of "Operation hours counter"" is enabled, data type can be selected by "Object data type of "Operation hours counter"", the unit of 2byte type is hour, and the unit of 4byte is second.																											
7	Scene	Output 1-{{...}}	1byte	C,W	18.001 DPT_SceneControl																						
The scene can be called or stored by sending an 8-bit instruction through this communication object. This communication object is enabled as long as the scene function is enabled. The meaning of the 8-bit instruction is explained in detail below.																											
Set an 8-bit instruction to (binary code): FXNNNNNN																											
F: "0" is the calling scene; "1" is the storage scene;																											
X: 0;																											
NNNNNN: Scene no. (0...63)																											
The parameter setting option is 1~64. In fact, the scene message received by the communication object "Scene" corresponds to 0~63. If scene 1 is set in the parameter, the communication object "Scene" should receive the scene message 0. As follows:																											
<table border="1" style="margin-left: auto; margin-right: auto;"> <thead> <tr> <th style="text-align: center;">Object message value</th> <th style="text-align: center;">Description</th> </tr> </thead> <tbody> <tr> <td style="text-align: center;">0</td> <td style="text-align: center;">recall scene1</td> </tr> <tr> <td style="text-align: center;">1</td> <td style="text-align: center;">recall scene2</td> </tr> <tr> <td style="text-align: center;">2</td> <td style="text-align: center;">recall scene3</td> </tr> <tr> <td style="text-align: center;">...</td> <td style="text-align: center;">...</td> </tr> <tr> <td style="text-align: center;">63</td> <td style="text-align: center;">recall scene64</td> </tr> <tr> <td style="text-align: center;">128</td> <td style="text-align: center;">storage scene1</td> </tr> <tr> <td style="text-align: center;">129</td> <td style="text-align: center;">storage scene2</td> </tr> <tr> <td style="text-align: center;">130</td> <td style="text-align: center;">storage scene3</td> </tr> <tr> <td style="text-align: center;">...</td> <td style="text-align: center;">...</td> </tr> <tr> <td style="text-align: center;">191</td> <td style="text-align: center;">storage scene64</td> </tr> </tbody> </table>						Object message value	Description	0	recall scene1	1	recall scene2	2	recall scene3	63	recall scene64	128	storage scene1	129	storage scene2	130	storage scene3	191	storage scene64
Object message value	Description																										
0	recall scene1																										
1	recall scene2																										
2	recall scene3																										
...	...																										
63	recall scene64																										
128	storage scene1																										
129	storage scene2																										
130	storage scene3																										
...	...																										
191	storage scene64																										

8	Forced output	Output 1-{{...}}	1bit 2bit	C,W	1.003 DPT_Enable 2.001 DPT_Switch control
<p>This communication object is enabled after the enforcement function is enabled.</p> <p>In 1 bit, when the message value "1" is received, the enforcement mode is enabled. At this time, the device ignores other actions except for enforcement. When the message value "0" is received, the forced execution mode is ended, and the position of the contact at the time of forced operation is set by the parameter.</p> <p>At 2bit, the contact is forcibly closed when the message value "3" is received; The contact is forcibly disconnected when the message value "2" is received; the enforcement mode is canceled when the message value "1" or "0" is received.</p>					
9	Logic 1	Output 1-{{...}}	1bit	C,W	1.002 DPT_Bool
<p>This communication object is enabled when the parameter "The input 1 of logic" is enabled for the logic input of input1.</p>					
10	Logic 2	Output 1-{{...}}	1bit	C,W	1.002 DPT_Bool
<p>This communication object is enabled when the parameter "The input 2 of logic" is enabled for the logic input of input2.</p>					

Table 5.2.1 Communication object table of switch output

5.2.2. Communication object of heating actuator(without controller)

Number	Name	Object Function	Description	Group Address	Length	C	R	W	T	U	Data Type	Priority
2	Output 1-...	On-off control value			1 bit	C	-	W	-	-	switch	Low
3	Output 1-...	Status of contact			1 bit	C	R	-	T	-	switch	Low
7	Output 1-...	Report fault			1 bit	C	R	-	T	-	alarm	Low
8	Output 1-...	Forced output			1 bit	C	-	W	-	-	enable	Low

1bit (on-off control or PWM))

Number	Name	Object Function	Description	Group Address	Length	C	R	W	T	U	Data Type	Priority
3	Output 1-...	Status of contact			1 bit	C	R	-	T	-	switch	Low
4	Output 1-...	Status of continuous, 1bit			1 bit	C	R	-	T	-	switch	Low
5	Output 1-...	Control value(Continuous)			1 byte	C	-	W	-	-	percentage (0..100%)	Low
6	Output 1-...	Status of continuous, 1byte			1 byte	C	R	-	T	-	percentage (0..100%)	Low
7	Output 1-...	Report fault			1 bit	C	R	-	T	-	alarm	Low
8	Output 1-...	Forced output			1 bit	C	-	W	-	-	enable	Low

1byte(Continuous))

Fig. 5.2.2 Communication object of switch output-heating actuator(without controller)

No.	Object function	Name	Type	Flags	DPT
2	On-off control value	Output 1-{{...}}	1bit	C,W	1.001 DPT_Switch
The communication object is enable when option “1bit(on-off control or PWM)” is selected in parameter “Control telegram is received as”, sending 1 bit control value via this object. When receive “0”, the valve close; when receive “1”, the valve open.					
3	Status of contact	Output 1-{{...}}	1bit	C,R,T	1.001 DPT_Switch
This communication object is enabled when “Yes, 1= contact close; 0=contact open” or “Yes, 0= contact close; 1= contact open” is selected in parameter “Reply the status for contact” .This communication object can directly indicate the status of contact.					
5	Control value (continuous)	Output 1-{{...}}	1byte	C,W	5.001 DPT_Scaling
The communication object is enabled when option “1byte(Continuous)” is selected in parameter “Control telegram is received as”, sending 1 byte control value via this object. The value range of the object is 0..100%, when receive “0%”, the valve close; when received “100%”, the valve all open.					
4	Status of continuous,1 bit	Output 1-{{...}}	1bit	C,R,T	1.001 DPT_Switch
This communication object is enabled when option” Yes , 0%=0, otherwise “1”(1bit)”or “Yes , 0%=1, otherwise “0”(1bit)” is selected in parameter” Reply the status for continuous control”. This object indicates the running status of the current valve. When “Yes, 0% =0, otherwise”1”(1 bit)” is selected, telegram “0” indicates valve close, telegram “1” indicates other cases; When “Yes, 0% =1, otherwise”0”(1 bit)” is selected, telegram “1” indicates valve close, telegram “0” indicates other cases.					
6	Status of continuous,1 byte	Output 1-{{...}}	1byte	C,R,T	5.001 DPT_Scaling
This communication object is enabled when option “Yes, continues control value (1byte) ” is selected in parameter ” Reply the status for continuous control”. The object indicates the running status of the current valve, for knowing the setting value of the PWM control.					
7	Report fault	Output 1-{{...}}	1bit	C,R,T	1.005 DPT_Alarm
The communication object is visible when enable monitor function and “Send object “Report fault” is” is enabled, the object for indicating whether room temperature controller is faulty, object value “1” indicate enter faulty mode, “0” indicate exit faulty mode.					
8	Forced output	Output 1-{{...}}	1bit	C,W	1.003 DPT_Enable
This communication object is enabled after the enforcement function is enabled.					

When the logic value "1" is received, the enforcement mode is enabled. At this time, the device ignores other actions except for enforcement. When the logic value "0" is received, the forced execution mode is ended. When forced execution, the position of the contact at the time of forced operation is set by the parameter. Exit enforcement, control status recover the status before.

Table 5.2.2 Communication object table for switch output-heating actuator(without controller)

5.3. Communication object of curtain (AC/DC) output

The communication object of the curtain AC and the curtain DC output is basically similar. Therefore, the object of the curtain AC output is taken as an example here.

Number	Name	Object Function	Description	Group Address	Length	C	R	W	T	U	Data Type	Priority
2	Curtain 1-...	Move UP/DOWN			1 bit	C	-	W	-	-	up/down	Low
3	Curtain 1-...	Slat adj/stop			1 bit	C	-	W	-	-	step	Low
4	Curtain 1-...	Reference movement			1 bit	C	-	W	-	-	up/down	Low
5	Curtain 1-...	Move to position 0..100%			1 byte	C	-	W	-	-	percentage (0..100%)	Low
6	Curtain 1-...	Slat position 0..100%			1 byte	C	-	W	-	-	percentage (0..100%)	Low
7	Curtain 1-...	Scene			1 byte	C	-	W	-	-	scene control	Low
8	Curtain 1-...	Status Position 0..100%			1 byte	C	R	-	T	-	percentage (0..100%)	Low
9	Curtain 1-...	Slat status 0..100%			1 byte	C	R	-	T	-	percentage (0..100%)	Low
10	Curtain 1-...	Sun operation			1 bit	C	-	W	-	-	switch	Low
11	Curtain 1-...	Enable auto.control			1 bit	C	-	W	-	-	enable	Low
12	Curtain 1-...	Sun:blind position 0..100%			1 byte	C	-	W	-	-	percentage (0..100%)	Low
13	Curtain 1-...	Sun:slat adj. 0..100%			1 byte	C	-	W	-	-	percentage (0..100%)	Low
14	Curtain 1-...	Safety operation 1			1 bit	C	-	W	-	-	alarm	Low
15	Curtain 1-...	Safety operation 2			1 bit	C	-	W	-	-	alarm	Low
16	Curtain 1-...	Status of operation			1 byte	C	R	-	T	-		Low

Fig. 5.3 Communication objects of curtain (AC) output

No.	Object function	Name	Type	Flags	DPT
2	Move UP/DOWN	Curtain 1-{{...}}	1bit	C,W	1.008 DPT_UpDown
<p>If the communication object receives a message of "0", the blinds/curtains move up ; If the object receives the message "1", the blinds/curtains move down. Telegram value:</p> <p style="padding-left: 40px;">0 -- the blinds move up / the curtains open 1 -- the blinds moving down / curtains closed</p> <p>The name in parentheses changes with the parameter "Description (max.30 char.)". If description is empty, display "Curtain 1-..." by default. The same below.</p>					
3	Slat adj. / Stop	Curtain 1-{{...}}	1bit	C,W	1.007 DPT_Step
3	Stop	Curtain 1-{{...}}	1bit	C,W	1.007 DPT_Step
<p>If the blind is in the mobile operation, when the communication object receives a message of "0" or "1", the operation stops. Venetian Blind operated mode: If the blind is not running, the communication object adjusts the louver upward when receiving the message "0", and adjusts the louver downward when receiving the message "1".</p>					

Shutter operation mode: If the curtain is not running, the communication object will not perform any action when receiving any message. Telegram value:

- 0 -- stop/adjust the louver upwards
- 1 -- stop/down adjust louver

When the louver is adjusted to the limit position, the adjustment message will be ignored when the adjustment is continued.

4	Reference movement	Curtain 1-{{...}}	1bit	C,W	1.008 DPT_UpDown
----------	---------------------------	--------------------------	-------------	------------	-------------------------

When the parameter "After reference movement, Position is" is not "disable", this object is enabled, The object is used to make a reference movement of the blinds/curtains to ensure accurate positioning of the blinds/curtains. Etailed description in the parameters section. Telegram value:

- 0 -- the blinds/curtains run to the top and then run to the target position
- 1 -- the blinds/curtains run to the bottom and then run to the target position

5	Move to position 0...100%	Curtain 1-{{...}}	1byte	C,W	5.001 DPT_Scaling
----------	----------------------------------	--------------------------	--------------	------------	--------------------------

If the communication object receives a message value, the blinds/curtains move to the position corresponding to this value. In the "Venetian Blind" operating mode, the position of the louver does not change, after moving to the target position, the position of the louver is adjusted to the previous position, unless the communication object "Slat position 0...100%" receives a message value, The position of the louver will be positioned accordingly based on this message value. Telegram value:

- 0% -- move to the top
- -- middle position
- 100% -- move to the bottom

6	Slat position 0...100%	Curtain 1-{{...}}	1byte	C,W	5.001 DPT_Scaling
----------	-------------------------------	--------------------------	--------------	------------	--------------------------

The communication object is only visible in the "Venetian Blind" mode of operation. If the communication object receives a message value, the louver performs corresponding positioning according to the message value. Telegram value:

- 0% -- the louver is fully open
- -- middle position
- 100% -- louvers are completely closed

7	Scene	Curtain 1-{{...}}	1byte	C,W	18.001 DPT_SceneControl
----------	--------------	--------------------------	--------------	------------	--------------------------------

The scene of the shutter actuator can be called or stored by sending an 8-bit instruction via this communication object. The meaning of the 8-bit instruction is explained in detail below.

Set an 8bit instruction to (binary code): FXNNNNNN

F: Calling the scene for '0'; storing the scene for '1';

X: 0;

NNNNNN: Scenes no. (0...63).

The parameter setting option is 1~64. In fact, the scene message received by the communication object "Scene" corresponds to 0~63. If the scene is set in the parameter 1, the communication object "Scene" receives the scene as 0. as follows:

Object message value	Description
0	Recall scene 1
1	Recall scene 2
2	Recall scene 3
...	...
63	Recall scene 64
128	Storage scene 1
129	Storage scene 2
130	Storage scene 3
...	...
191	Storage scene 64

8	Position status 0..100%	Curtain 1-{{...}}	1byte	C,R,T	5.001 DPT_Scaling
<p>The communication object is used to send the position of the blinds/curtains, and when the blinds/curtains run to the target position, the location is immediately sent to the bus. Telegram value:</p> <p>0% -- at the top -- middle position 100%-- at the bottom</p>					
9	Slat status 0..100%	Curtain 1-{{...}}	1byte	C,R,T	5.001 DPT_Scaling
<p>The communication object is only visible in the "Venetian Blind" mode of operation and is used to transmit the position of the louver. When the louver runs to the target position, the louver position is immediately sent to the bus. Telegram value:</p> <p>0% -- the louver is fully open -- middle position 100% -- louvers are completely closed</p>					
10	Sun operation	Curtain 1-{{...}}	1bit	C,W	1.001 DPT_Switch
<p>When the communication object receives the message "0" or "1", the blinds move to the predefined position, as described in the parameter section.</p>					
11	Enable auto. control	Curtain 1-{{...}}	1bit	C,W	1.003 DPT_Enable
<p>This communication object is used to disable and enable automatic operation. It receives the message "0" and exits the automatic operation; it receives the message "1" and enables automatic operation. Telegram value:</p> <p>0-- exit automatic operation 1-- enable automatic operation</p>					

12	Sun:blind/shutter position0...100%	Curtain 1-{{...}}	1byte	C,W	5.001 DPT_Scaling
<p>Under automatic operation, if the communication object receives a message value, the blinds/curtains move to the position corresponding to this value. In the "Venetian Blind" operating mode, the position of the louver does not change unless the communication object "Sun:slat adj. 0...100%" receives a message value, and the position of the louver is positioned accordingly according to the value of the message. Telegram value:</p> <p style="padding-left: 40px;">0% -- move to the top -- middle position 100%-- move to the bottom</p>					
13	Sun: slat adj. 0...100%	Curtain 1-{{...}}	1byte	C,W	5.001 DPT_Scaling
<p>Under automatic operation, this communication object is only visible in the "Venetian Blind" operation mode. If the communication object receives a message value, the louver performs corresponding positioning according to the message value. Telegram value:</p> <p style="padding-left: 40px;">0% -- the louver is fully open -- middle position 100% -- louvers completely closed</p>					
14	Safety operation 1	Curtain 1-{{...}}	1bit	C,W	1.005 DPT_Alarm
15	Safety operation 2	Curtain 1-{{...}}	1bit	C,W	1.005 DPT_Alarm
<p>This communication object is used to receive messages sent from the sensor cyclically (0 or 1, depending on the parameter settings), If the value of the cancel security operation is "1", the object can receive the message "1" from the sensor during the monitoring period., indicates that no abnormality has occurred at this time, monitoring continues, and the monitoring period is reset. If the object does not receive this message during the monitoring period, the actuator will consider the sensor to be faulty , once the monitoring cycle is over and the security operation is performed immediately , move the blinds to a safe location.</p> <p>Safety operation 2 has priority over Safety operation 1.</p>					
16	Status of operation	Curtain 1-{{...}}	1byte	C,R,T	No DPT
<p>This object is used to send the current operating state of the blind/curtain output, and only one operation can be activated at a time. This object sends a message when the operation changes. The definition of the 8-bit instruction is described in detail below:</p> <p style="padding-left: 40px;">0 - normal operation 1- manual operation (button operation) 2 - automatic operation (sun protection) 3 - Safety operation 1 4 - Safety operation 2</p> <p>Other values not used</p>					

Table 5.3 Communication Object Table for Curtain (AC) Output

5.4. Communication object of fan control

Number	Name	Object Function	Description	Group Address	Length	C	R	W	T	U	Data Type	Priority
219	Fan 1-...	Fan speed			1 bit	C	-	W	-	-	switch	Low
223	Fan 1-...	Status Fan ON/OFF			1 bit	C	R	-	T	-	switch	Low
228	Fan 1-...	Automatic function			1 bit	C	-	W	-	-	enable	Low
229	Fan 1-...	Status Automatic			1 bit	C	R	-	T	-	enable	Low
230	Fan 1-...	Forced operation			1 bit	C	-	W	-	-	enable	Low
231	Fan 1-...	Control value 1			1 byte	C	-	W	-	-	percentage (0..100%)	Low
232	Fan 1-...	Control value 2			1 byte	C	-	W	-	-	percentage (0..100%)	Low
233	Fan 1-...	Switching control value 1/2			1 bit	C	-	W	-	-	switch	Low
234	Fan 1-...	Control value fault			1 bit	C	R	-	T	-	alarm	Low

Fig.5.4(1) Communication object of Fan control_One level

Number	Name	Object Function	Description	Group Address	Length	C	R	W	T	U	Data Type	Priority
219	Fan 1-...	Fan speed			1 byte	C	-	W	-	-	fan stage (0..255)	Low
220	Fan 1-...	Fan speed 1			1 bit	C	-	W	-	-	switch	Low
221	Fan 1-...	Fan speed 2			1 bit	C	-	W	-	-	switch	Low
222	Fan 1-...	Fan speed 3			1 bit	C	-	W	-	-	switch	Low
223	Fan 1-...	Status Fan ON/OFF			1 bit	C	R	-	T	-	switch	Low
224	Fan 1-...	Status Fan speed			1 byte	C	R	-	T	-	fan stage (0..255)	Low
225	Fan 1-...	Status Fan speed 1			1 bit	C	R	-	T	-	switch	Low
226	Fan 1-...	Status Fan speed 2			1 bit	C	R	-	T	-	switch	Low
227	Fan 1-...	Status Fan speed 3			1 bit	C	R	-	T	-	switch	Low
228	Fan 1-...	Automatic function			1 bit	C	-	W	-	-	enable	Low
229	Fan 1-...	Status Automatic			1 bit	C	R	-	T	-	enable	Low
230	Fan 1-...	Forced operation			1 bit	C	-	W	-	-	enable	Low
231	Fan 1-...	Control value 1			1 byte	C	-	W	-	-	percentage (0..100%)	Low
232	Fan 1-...	Control value 2			1 byte	C	-	W	-	-	percentage (0..100%)	Low
233	Fan 1-...	Switching control value 1/2			1 bit	C	-	W	-	-	switch	Low
234	Fan 1-...	Control value fault			1 bit	C	R	-	T	-	alarm	Low

Fig. 5.4(1) Communication object of Fan control_Multi-level

No.	Object function	Name	Type	Flags	DPT
219	Fan speed	Fan 1-{{...}}	1bit 1byte	C,W	1.001 DPT_Switch 5.001 DPT_Scaling 5.100 fan stage
<p>For one-level fan speed fans, the object is a 1-bit type for switching fans. Telegram value:</p> <p style="padding-left: 40px;">0 --Fan off</p> <p style="padding-left: 40px;">1 --Fan on</p> <p>For multi-level fan speed fans, the object is 1byte type, it is used to switch the fan speed of each fan. At the same time, only one fan speed is open., at the same time, when opening a new fan speed, you need to consider the starting characteristics of the fan speed.. The object value corresponding to each fan speed is defined by a parameter, and the message value is 1..255 or 1...100 %, 0 is the Fan off.</p> <p>The name in parentheses changes with the parameter "Description (max.30 char.)". If description is empty, display "Fan 1-..." by default. The same below.</p>					
220	Fan speed 1	Fan 1-{{...}}	1bit	C,W	1.001 DPT_Switch
<p>This object is available under multi-level fan speed fans.</p> <p>It is used to turn on the fan speed 1. If the communication object of the fan speed 1~3 receives several ON messages continuously in a short time, the speed of the fan is turned on based on the last received message.</p>					

<p>In the communication object with fan speed 1~3, as long as one of the messages receives OFF, the fan will be turned off.</p> <p>Telegram value:</p> <p style="padding-left: 40px;">0 --Fan off</p> <p style="padding-left: 40px;">1 --Turn on the fan speed 1</p>					
221	Fan speed 2	Fan 1-{{...}}	1Bit	C,W	1.001 DPT_Switch
Refer 220					
222	Fan speed 3	Fan 1-{{...}}	1Bit	C,W	1.001 DPT_Switch
Refer 220					
223	Status Fan ON/OFF	Fan 1-{{...}}	1bit	C,R,T	1.001 DPT_Switch
<p>This object is used to send the switch status of the fan to the bus. As long as there is fan speed, the fan is on. Telegram value:</p> <p style="padding-left: 40px;">0 --Fan off</p> <p style="padding-left: 40px;">1 --Fan on</p>					
224	Status Fan speed	Fan 1-{{...}}	1byte	C,R,T	5.001 percentage(0..100%) 5.100 fan stage
<p>This object is available under multi-level fan speed fans.</p> <p>Used to send the current running fan speed to the bus. The message value corresponding to each level of fan speed is specified by the parameter "Status value for Fan speed 1/2/3", and the message "0": fan mechanism.</p>					
225	Status Fan speed 1	Fan 1-{{...}}	1bit	C,R,T	1.001 DPT_Switch
<p>This object is available under multi-level fan speed fans.</p> <p>Used to send the operating state of fan speed 1 to the bus. Telegram value:</p> <p style="padding-left: 40px;">0 --Off the fan speed 1</p> <p style="padding-left: 40px;">1 --Turn on fan speed 1</p>					
226	Status Fan speed 2	Fan 1-{{...}}	1bit	C,R,T	1.001 DPT_Switch
Refer 225					
227	Status Fan speed 3	Fan 1-{{...}}	1bit	C,R,T	1.001 DPT_Switch
Refer 225					
228	Automatic function	Fan 1-{{...}}	1bit	C,W	1.003 DPT_Enable
<p>This object is used to activate automatic operations.</p> <p>After the bus is reset or programmed, whether the automatic operation is activated depends on the parameters. Normal operation can exit the automatic operation.</p>					

Under automatic operation, for multi-level fan speed, if the forced operation is activated, the automatic operation is still active, only the state of the fan that is allowed to operate is determined by the forced operation, following the fan speed allowed under the forced operation. For one-level fan speed, the forced operation can exit the automatic operation.

Parameter option "0=Auto/1=Cancel":

- 0 -- Activate automatic operation
- 1 -- Exit automatic operation

Parameter option "1=Auto/0=Cancel":

- 0 -- Exit automatic operation
- 1 -- Activate automatic operation

Normal operations are actions that are triggered by the following objects:

- Object 219: Fan X--Fan speed
- Object 220-222: Fan X-- Fan speed x (x=1, 2, 3,)

229	Status Automatic	Fan 1-{{...}}	1bit	C,R,T	1.003 DPT_Enable
<p>This object is used to send the status of automatic operations to the bus.</p> <ul style="list-style-type: none"> 0 -- Automatic operation is not activated 1 -- Automatic operation is activated 					
230	Forced Operation	Fan 1-{{...}}	1bit	C,W	1.003 DPT_Enable
<p>This object is used to activate a forced action. When the forced operation is activated, the fan speed at which the fan can operate is set by the parameter "Limitation on forced operation".</p> <p>Parameter option "0=Force/1=Cancel":</p> <ul style="list-style-type: none"> 0 -- Activate forced operation 1 -- Cancel the mandatory operation <p>Parameter option "1=Force/0=Cancel":</p> <ul style="list-style-type: none"> 1 -- Activate forced operation 0 -- Cancel the forced operation 					
231	Control value	Fan 1-{{...}}	1byte	C,W	5.001 DPT_Scaling
231	Control value 1	Fan 1-{{...}}	1byte	C,W	5.001 DPT_Scaling
232	Control value 2	Fan 1-{{...}}	1byte	C,W	5.001 DPT_Scaling
<p>Under automatic operation, when the control value of the fan speed is set to 1, the Control value is visible; when the control value is set to 2, the Control value 1/2 is visible.</p> <p>These three objects are used to receive control values from the bus, and the fan output will output fan speed based on the threshold range in which the control values are located.</p>					

233	Switching control value 1/2	Fan 1-{{...}}	1bit	C,W	1.001 DPT_Switch
<p>When the fan speed control value is set to 2, this object is visible and is used to select the control value. Telegram value:</p> <p style="padding-left: 40px;">0 ---Control value 1 1 ---Control value 2</p>					
234	Control value fault	Fan 1-{{...}}	1bit	C,R,T	1.005 DPT_Alarm
<p>During the monitoring time, when the device does not receive the control value from the external controller, this object will report a control value error. Once the control value is received, the error status is released. Telegram value:</p> <p style="padding-left: 40px;">0 ---No error 1 ---An error occurred</p>					

Table 5.4 Communication control table of fan control

5.5. Communication object of valve output

Communication object description of valve output takes 4 pipes system as an example:

Number	Name	Object Function	Description	Group Address	Length	C	R	W	T	U	Data Type	Priority
315	4-pipe Valve 1-...	Heat/Cool mode status			1 bit	C	R	-	T	-	cooling/heating	Low
316	4-pipe Valve 1-...	Control value fault			1 bit	C	R	-	T	-	alarm	Low
317	4-pipe Valve 1-...	Disable,Heat			1 bit	C	-	W	-	-	enable	Low
318	4-pipe Valve 1-...	Control value, Heat			1 bit	C	-	W	-	-	switch	Low
319	4-pipe Valve 1-...	Valve status, Heat			1 bit	C	R	-	T	-	switch	Low
320	4-pipe Valve 1-...	Trigger valve purge, Heat			1 bit	C	-	W	-	-	enable	Low
321	4-pipe Valve 1-...	Valve purge status, Heat			1 bit	C	R	-	T	-	enable	Low
322	4-pipe Valve 1-...	Disable,Cool			1 bit	C	-	W	-	-	enable	Low
323	4-pipe Valve 1-...	Control value, Cool			1 byte	C	-	W	-	-	percentage (0..100%)	Low
324	4-pipe Valve 1-...	Valve status, Cool			1 bit	C	R	-	T	-	switch	Low
325	4-pipe Valve 1-...	Trigger valve purge, Cool			1 bit	C	-	W	-	-	enable	Low
326	4-pipe Valve 1-...	Valve purge status, Cool			1 bit	C	R	-	T	-	enable	Low

Fig. 5.5 Communication object description of valve output

No.	Object function	Name	Type	Flags	DPT
315	Heat/Cool mode status	4-pipe Valve 1-{{...}}	1bit	C,R,T	1.100 DPT_Heat/Cool
<p>This object is used to feed back the heating/cooling status of the current valve output and is sent to the bus when changing. Telegram value:</p> <p style="padding-left: 40px;">0 ---Cooling 1 ---Heating</p>					
316	Control value fault	4-pipe Valve 1-{{...}}	1bit	C,R,T	1.005 DPT_Alarm
<p>This object will report a control value error when the device cannot receive a control value from the external controller during the monitoring time. Once the control value is received, the error status is released. Telegram value:</p> <p style="padding-left: 40px;">0 ---No error 1 ---An error occurred</p>					

317	Disable, Heat	4-pipe Valve 1-{{...}}	1bit	C,W	1.003 DPT_Enable
322	Disable, Cool	4-pipe Valve 1-{{...}}	1bit	C,W	1.003 DPT_Enable
<p>Through this communication object, the heating/cooling valve can be disabled or enabled. When disabled, the valve position is immediately adjusted back to 0% (off state), and when enabled again, the valve action is controlled based on the current control value.</p>					
318	Control value, Heat	4-pipe Valve 1-{{...}}	1byte 1bit	C,W	5.001 DPT_Scaling 1.001 DPT_Switch
323	Control value, Cool	4-pipe Valve 1-{{...}}	1byte 1bit	C,W	5.001 DPT_Scaling 1.001 DPT_Switch
<p>This communication object is used to receive valve control values from other controllers.</p> <p>Under the 2-tube system, the heating valve and the cooling valve share an object (318) to receive the valve control value.</p> <p>This control value can be 1 bit or 1 byte, depending on the valve control mode type.</p>					
319	Valve status, Heat	4-pipe Valve 1-{{...}}	1byte 1bit	C,R,T	5.001 DPT_Scaling 1.001 DPT_Switch
324	Valve status, Cool	4-pipe Valve 1-{{...}}	1byte 1bit	C,R,T	5.001 DPT_Scaling 1.001 DPT_Switch
<p>This object is used to indicate the switch status or position status of the valve. The object type is determined by the parameter settings.</p>					
320	Trigger valve purge, Heat	4-pipe Valve 1-{{...}}	1bit	C,W	1.003 DPT_Enable
325	Trigger valve purge, Cool	4-pipe Valve 1-{{...}}	1bit	C,W	1.003 DPT_Enable
<p>This communication object is used to trigger the cleaning function of the valve. When cleaning, the valve is fully opened. Telegram value:</p> <p style="padding-left: 40px;">0 --End purge</p> <p style="padding-left: 40px;">1 --Trigger purge</p>					
321	Valve purge status, Heat	4-pipe Valve 1-{{...}}	1bit	C,R,T	1.003 DPT_Enable
326	Valve purge status, Cool	4-pipe Valve 1-{{...}}	1bit	C,R,T	1.003 DPT_Enable
<p>This communication object is used to indicate the cleaning status of the valve. Once the cleaning function is activated, its status is immediately indicated. Telegram value:</p> <p style="padding-left: 40px;">0 --Purge function is not activated</p> <p style="padding-left: 40px;">1 --Purge function activated</p>					

Table 5.5 Communication object table of valve output