



enertexbayern gmbh
simulation entwicklung consulting

Manual and configuration

Enertex® MeTa² KNX room controller



for Premium and Standard variants

Note

The contents of this document may not be reproduced, transmitted, distributed or stored in any form, in whole or in part, without the prior written permission of Enertex® Bayern GmbH.

Enertex® is a registered trademark of Enertex® Bayern GmbH. Other product and company names mentioned in this manual may be trademarks or trade names of their respective owners.

This manual is subject to change without notice or announcement and makes no claim to completeness or correctness.

Inhalt

Notes.....	5
<i>Demo mode.....</i>	5
<i>Parameter description in the ETS.....</i>	5
Connection instructions.....	6
<i>Assembly.....</i>	6
Programming mode and firmware information.....	7
Factory reset.....	7
Mode of operation.....	8
<i>Overview.....</i>	8
Description.....	8
Function overview.....	8
Variants.....	9
Premium.....	9
Standard.....	9
<i>Display and control elements.....</i>	9
Operation.....	9
Representation.....	11
Colors.....	11
Font.....	11
Configuring Message Encoding.....	11
Brightness control.....	11
Burn in protection.....	11
Cleaning mode.....	12
Functions, channel function and rockers.....	13
Dimmer example.....	14
Subfunctions.....	14
Rocker displays.....	14
(Channel) Function displays.....	14
Rocker operation and single button operation.....	16
Icon families.....	16
Operating icons.....	16
Feedback icon.....	16
Overlaps.....	16
Label displays.....	17
Event messages.....	17
Alarms.....	17
Info displays.....	18
Premium display.....	19
Overview.....	19
Info display.....	20
Event messages.....	21
Alarm messages.....	21
Solar display.....	22
Weather info.....	22
Three-line info display.....	23
Signal tone.....	23
Inputs.....	23
<i>Motion detector.....</i>	24
Display control.....	24
Zone detection.....	24

<i>Measured variables</i>	25
Temperature measurement.....	25
Humidity measurement.....	25
Dew point.....	25
Light sensor.....	26
<i>Time display</i>	26
<i>Controller</i>	26
Temperature.....	26
Heating and/or cooling.....	26
Operating modes.....	27
Comfort.....	27
Standby.....	27
Night.....	27
Building protection.....	27
Operating mode.....	27
Setpoints and operating modes.....	28
Setpoint shift.....	28
Independent setpoints.....	29
Controller type.....	30
Fundamentals.....	30
PI controller.....	30
PI controller with PWM output.....	31
Two-Point controller.....	32
Additional levels.....	32
Fan control.....	33
FanCoil.....	33
Split unit.....	34
Rocker operation and sub-functions.....	34
<i>Controller extensions</i>	35
Main unit and extension unit.....	35
Rocker operation and sub-functions.....	36
<i>Split units (extensions)</i>	36
Application.....	36
Rocker operation und sub-functions.....	36
<i>Logic function</i>	37
<i>Channel functions</i>	37
Switching.....	37
Dimming.....	37
Absolute and relative dimming.....	37
Subfunctions.....	37
Icons.....	38
Dimming Tuneable White.....	38
Absolute and relative colored light control.....	38
Energex® KNX LED Dimmsequenzer 20A/5x.....	38
Subfunctions.....	39
RGB colored light control.....	39
RGB colors.....	39
Energex® KNX LED Dimmsequenzer 20A/5x.....	40
Subfunctions.....	40
Roller shutter/Awning.....	41
Blinds.....	41
Operation.....	41
Subfunctions.....	41
Value provider.....	42
Data types.....	42
Scene extension.....	42
Jump.....	42
2-channel operation.....	42
Icons	44
<i>Single icons</i>	44
HVAC.....	44
Time.....	45

Window.....	46
Other.....	46
Control.....	49
Room.....	51
Scenes.....	52
Measure.....	53
Light.....	54
<i>Icon families</i>	56
ETS application	65
<i>Specification</i>	65
<i>Database file</i>	65
<i>Parameters</i>	65
<i>Communication objects</i>	65
Technical data	78

Notes

- Electrical devices may only be installed and assembled by qualified electricians.
- When connecting KNX interfaces, specialist knowledge from KNX training courses is required.
- Failure to follow the instructions may result in damage to the appliance, fire or other hazards.
- These instructions are part of the product and must remain with the end user.
- The manufacturer is not liable for any costs or damages incurred by the user or third parties through the use of this device, misuse or malfunctions of the connection, malfunctions of the device or the subscriber devices.
- Opening the housing, other unauthorized changes or modifications to the device will invalidate the warranty!
- The manufacturer is not liable for improper use.

Demo mode

Demo mode is displayed on the device in the delivery state or after unloading the device via the ETS or the factory reset.

This demo mode shows the wide range of application and parameterization options of the MeTa². Take your time to get to know the device better in this mode and operate the buttons or rockers on the device. All actions are carried out in pure simulation mode and do not trigger any telegrams or actions on the bus.

Parameter description in the ETS

The documentation of the application parameters is largely integrated directly in the ETS. To display explanations and help texts, select the MeTa² application in the ETS and activate the Context help button in the context menu bar.

Connection instructions

Assembly

Installation must be carried as follows:

- Mount the mounting plate in the correct position on the appliance box (figure 1) .
- Optional for MeTa² Premium for additional attachment to the wall: Screw the mounting plate to the lower holes on the wall or to a second lower appliance box (figure 1).
- Connect the bus terminal (black / red) to the bus line.
- Optional: Connection of the external contact to the supplied plug-in screw terminal (green).
- Attach the MeTa² KNX unit incl. bus terminal and plug-in screw terminal to the mounting plate.
- Screw on the four black M2 screws to attach the MeTa² KNX unit to the mounting plate (see figure 2).

CAUTION: Do not use excessive torque.

- Remove the screen protector(s).

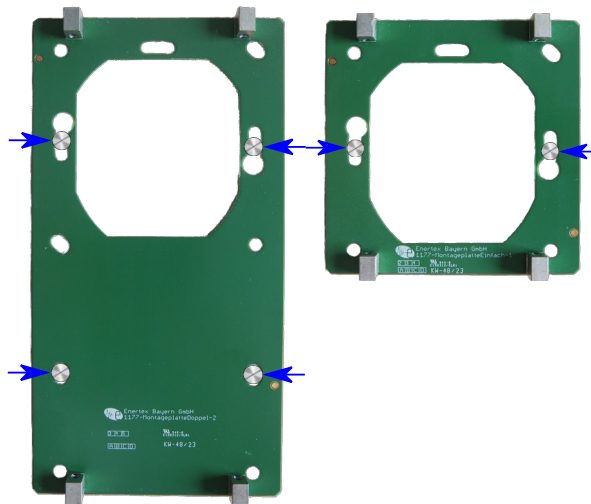

Figure 1: Fastening the mounting plate to the appliance box



Figure 2: Screwing the MeTa² KNX unit to the mounting plate

Programming mode and firmware information

Programming mode can be activated from the rear using a button (small screwdriver required). The red programming LED is visible recessed in the housing (figure 3).

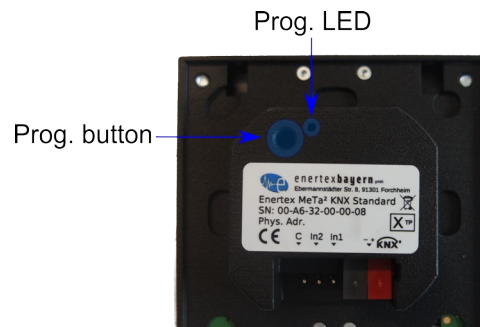

Figure 3: Programming LED

It is also possible to activate programming mode in the application via front operation. If this has been enabled, programming mode is activated via the right MeTa button or deactivated via any other button. In this case, the top rocker display shows a display as shown in figure 4.

By pressing and holding the left MeTa² button, the programming mode remains unchanged and the firmware information display appears. Figure 4 is displayed in the top rocker. The Prog LED on the rocker display indicates the status of the red programming LED recessed in the rear panel of the housing. The display 4 only disappears again when any button is pressed. The other rocker displays and the premium display are not updated while the firmware information display is active.



Figure 4: Firmware information display

The display figure 4 shows:

- the firmware version *FW*
- the font type *STD* and version *Font: v00*
- the icon set version *Icons v00*
- the Prog LED (red for active, otherwise inactive)
- the physical address *PHY*
- and in the event that the device has not been securely loaded:
 - the serial number *SNR*
 - the FDSK in QR format (square next to the PHY display). This can be translated into ASCII notation using, for example, the camera of a mid-range cell phone.

Factory reset

The Prog.button (3) can be used to reset the device to the factory settings (factory reset). To do this, the button must be held down for 10 seconds and then released again.

Mode of operation

Overview

Description

The Enertex® MeTa² KNX room controller combines sensor technology with the convenient feel of an easy-to-use rocker control, as well as a comprehensive control center and a temperature control system with modern TFT displays.

The label field of the individual rockers allows the display of the action to be carried out, including feedback, additional information displays, alarms and message functions. The housing front made of high-quality solid aluminum accommodates four high-resolution rocker displays with age-resistant colour TFT (IPS) technology in the premium version and two in the standard version, the black background of which is seamlessly integrated into the panes of the rockers.

The device has an integrated temperature and humidity sensor, as well as a light sensor. A radar sensor is installed to detect movements within a radius of up to three meters. This can be completely deactivated.

The device has two inputs that can be used either as a binary input (e.g. window contact or push-button input) or as an input for external temperature sensors.

The housing front of the black version is black anodized (solid) aluminium, the white version is white powder-coated (solid) aluminium. The gold version is made of milled brass with a genuine gold coating.

Function overview

The following functions are available in both variants:

- KNX room controller for precise temperature control and push-button sensor with mechanical rockers
- Two-stage room temperature control with individual setpoint specification for heating and cooling
- Control of up to four controller extensions
- Control of up to four split units
- Integrated three-stage fan control (fan coil actuator)
- 32 channels for switching, dimming, colored light control, tunable white control, blind control, value transmitter, scene recall and multimedia control, each with up to three sub-functions
- Built-in temperature and humidity sensor
- Integrated light sensor
- Motion detection by radar-based motion detector with a range of up to 3 m in 3 zones
- Alarm function with six configurable alarms (acoustic and/or visual)
- Output of three different signal tones in two volumes
- Support for up to eight logic functions
- Message function for recording and displaying up to 32 KNX events such as door contact openers
- Approx. 400 different icons, free choice of colors for texts and icons
- Integrated fonts for Western European and Eastern European languages, as well as for Cyrillic, Greek, Hebrew and Arabic
- Separate menu button ("MeTa") for switching between up to ten operating pages

- Two external binary inputs, can optionally be used as an input for a remote temperature sensor (e.g. Albrecht Jung item no.: FF NTC)
- Integrated bus coupling unit for power supply via the KNX bus (no additional power supply required)
- High-resolution rocker displays with age-resistant color TFT (IPS) technology and 0.1 mm resolution (480x60 dots)
- Compatible with standard flush-mounted boxes

Variants

Premium

- Four electronically inscribable, mechanical rocker switches for up to 80 individual switching functions
- Additional large display in age-resistant color TFT (IPS) technology with 0.1x0.1 mm resolution
- Visualization of PV generation, consumption, wallbox and battery storage directly on the display
- Visualization of weather forecasts (external KNX-capable server required, e.g. Enertex® EibPC²)
- Three-line freely parameterizable info display for versatile applications, such as multimedia displays or general messages.
- Large-format display of time, date, temperatures, etc.
- Dimension: 90 x 161 x 14.6 mm

Standard

- Two electronically inscribable, mechanical rocker switches with max. 40 switching functions
- Dimension: 90 x 90 x 14.6 mm

The software description applies to both variants.

Display and control elements

Operation

The MeTa² KNX room controller is a push-button sensor with mechanical rockers whose labeling field allows, among other things, the action to be carried out to be displayed when pressed. Each rocker has two pressure points for actuation at the two corners, which can either be used as individual buttons for various functions (e.g. ON/OFF on the left, VALUE ENTRY on the right) or can be assigned to a function (e.g. dimming) as a rocker switch. Each rocker can be assigned ten times. An assignment of all rockers (4 for Premium or 2 for Standard) corresponds to one operating level, which is referred to below as a page.

The reference to the rockers is defined in the ETS application as shown in figure 5.



Figure 5: Numbering of the rockers

The pages are switched using the MeTa button at the bottom of the control unit. The MeTa button (figure 6) is designed without a display and switches the pages in „carousel mode“, whereby the right rocker button increases the page number and the left rocker button decreases the page number.



Figure 6: Control elements

In addition, a rocker or individual push-button can be configured via application as a "jump button" to any page. Two 1 bit COs can be used to jump to specific pages via the bus. In addition, the desired page number for a (bus-triggered) page change can be sent via a further CO.

In general, rockers or individual buttons have implemented a repeat function for dimming and value adjustment when the button is held down. This cannot be parameterized and increases the adjustment value by a factor of 5 after the 3rd repetition (increment). A repetition is triggered after 700 ms and retriggered every 300 ms if the button is held down. The long button press is also fixed to 500ms in the device.

Representation

Colors

The background color of all displays is invariably black. The foreground color can be adjusted via the ETS application, whereby both predefined colors and a completely free RGB design are possible.

The factory setting is the predefined color "Alpine white".

- For devices with the black anodized aluminium front, we recommend the color "bronze"
- for the natural aluminum front "Aluminum"
- for the white powder-coated "Warm white"
- and for the brass, gold-coated "Gold"

Font

The MeTa² can show several font families in different sizes in its displays. To do this, the UTF-8 coded characters must be entered in the respective labeling fields of the ETS application. This is the default window setting of the ETS, so that the displayed characters are directly visible during input. All Western European and Eastern European fonts are available, as well as Cyrillic, Greek, Hebrew and Arabic. UTF-8 special characters, such as German umlauts, usually require 2 bytes per character, but a maximum of 3 bytes. In contrast, normal (ASCII) characters only require 1 byte. Each label field can generally process 28 bytes. The maximum label length is therefore 28 characters, and correspondingly less if 2 or 3 byte characters are used.

To send UTF-8 characters via KNX, we recommend a powerful logic engine such as the Ener-tex EibPC², which can send the data encoded accordingly. This is the only way to display um-lauts or Greek letters, for example.

Note

Special ligatures consisting of two individual letters, such as those found in Arabic or Hebrew, are not displayed, but appear as separate basic characters.

Configuring Message Encoding

Certain features, such as label displays, allow messages to be sent over the bus. By default, these messages are encoded using the ISO8859-1 standard, meaning each character consists exactly of one byte.

To switch encoding to UTF-8, please follow these steps:

1. Open the "**General**" tab in the settings menu.
2. Under the "**Encoding**" parameter, select "**UTF-8**".

Important Notes:

- ETS software is not capable of correctly displaying UTF-8 encoded messages in the Group Monitor.
- For proper handling and display of UTF-8 encoded messages, a powerful logic engine, such as the Ener-tex EibPC², is required. This device can correctly encode and transmit data over the bus.

Brightness control

The MeTa² devices are equipped with a light sensor. This is located on the top behind the alu-minium front. With the help of this sensor, the MeTa² can automatically adjust the display bright-ness of the rockers. The brightness can also be adjusted via CO. This can be set separately for the rocker displays and the premium display.

Burn in protection

All MeTa² displays are TFTs with IPS technology. In principle, these are less subject to ageing than OLEDs, for example. Nevertheless, pixels may "burn in" after some time. To prevent this, the MeTa² displays can be switched off after 2 hours depending on the time and switched on

again, e.g. with the integrated radar sensor, when approaching.

If the display is parameterized for continuous lighting, the burn-in protection is always activated after 2 hours for approx. 0.5 seconds. This reconfigures all pixels to effectively prevent burn-in. The user notices this by a brief flickering of the screens.

Cleaning mode

The MeTa² has an integrated cleaning mode. This can be switched on and off via CO or activated for a certain time if parameterized accordingly. When the cleaning mode is activated, all rocker displays show a configurable text and a configurable icon. If the cleaning mode is only active for a certain time, a countdown is displayed until the return to standard operating mode.

Button operation is completely disabled in this mode. The evaluation of the inputs (see section Inputs) is not affected by this.

Functions, channel function and rockers

The basic concept of the MeTa configuration is that functions and rockers are parameterized separately. The functions must be parameterized first and then assigned to the rockers. The advantage of this separation is that the assignment can be made multiple times, i.e. one and the same function can be assigned to side1/rocker1 and side2/rocker2 etc. The necessary links only have to be made once in the ETS.

- Functions are defined by a specification of KNX parameters and COs for a task. These are in detail:
- Two-stage room temperature controller with FanCoil control
- 4x controller extensions
- 4x split units
- Cleaning mode
- 4x log messages (event monitor with time stamp for 10 COs each)
- Solarinfo (Premium only)
- Weather info (Premium only)
- 32 channels
- Each of the 32 channels can be parameterized and used for the following tasks (referred to below as channel functions):
- Switching
- Dimming for brightness 0..100%
- Dimming for Tunable White actuators (warm white/cold white)
- Dimming for RGB actuators
- Roller blind / awning
- Venetian blind
- Valuator
- Scene extension
- Jump function (jump to the target page of the MeTa parameterization)
- 2-channel operation

Figure 7 illustrates this hierarchy. In these instructions, the controller is therefore referred to as a function and the switching of a channel as a channel function.

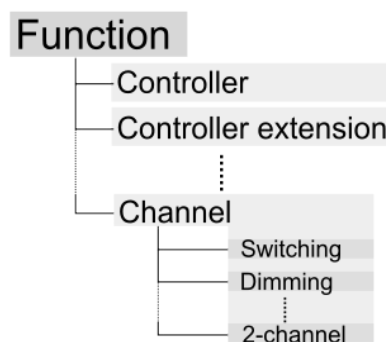

Figure 7: Functions and channel functions

Each of the functions or, in the case of channels, the channel functions can be assigned to a rocker. This determines which action or KNX telegrams the rocker operation triggers with this as-

segment, e.g. switching on/off. A function (or channel function) allows one or more different types of operation. Each of these operations is referred to as a sub-function (see example below). At least the standard sub-function is always available. Each sub-function can be assigned several times to different rockers.

Dimmer example

The standard sub-function here is as follows:

- Short press on/off
- Long button press relative dimming
- Release after long button press Stop telegram

So if the rocker is assigned to dimming with the standard sub-function, the user will see exactly this behavior.

In addition, the "Dimming On/Off" sub-function is available for dimming, which assigns the On/Off function to a rocker (switching via the corresponding CO). Dimming is not part of the operation here, i.e. no dimming telegrams are triggered.

Finally, the "Dimming" sub-function can be parameterized, which only sends the relative dimming telegram and no switching telegrams when rockers are assigned.

Subfunctions

Figure 8 illustrates this relationship and the assignment of the rockers:

A function (or channel function) F1 has 4 sub-functions S1F1, S2F1, S3F1, S4F1. The sub-functions S1F1 of the channel is assigned to rocker W1 on side M1, S2F1 is assigned to rocker W2 on side M1 and to the rocker in the single button operation to the left of W3 on side M2. The sub-function S1D2 of function F2 is assigned to the rocker in single-button operation to the right of W3 on side M2.

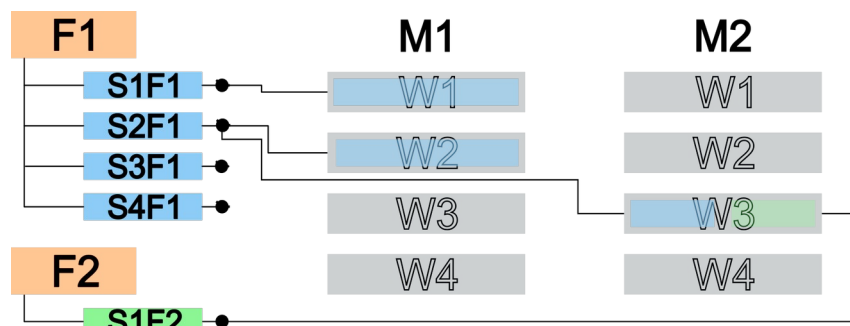

Figure 8: Rocker assignments

For each function (or channel function), at least the "Standard" sub-function exists in the application, see the documentation for the respective function (or channel function). If a sub-function is incorrectly assigned - e.g. dimming for a switching channel - the standard function is automatically selected by the firmware.

Rocker displays

(Channel) Function displays

The rocker displays visualize the (channel) function depending on the use of the button operation as a single button or rocker button. The rocker display can be centered or left-right aligned. The latter is the standard case and is shown in figure 9. The basic structure in rocker mode is as shown in figure 9 as follows:

- A1/A2: Operating icons
- B Label
- C Feedback icon
- D Feedback (either a slider with a value as shown or just a value display, the firm

ware determines the exact display itself)

- E Display of the current page (bright dot as the position of the page in the page carousel)

The E display is only shown on the bottom rocker display and cannot be configured.

The standard label of the rocker is defined in the function (or channel function). The alignment, the size of the font and the icons for operation and feedback are also defined in the function (or channel function).

No further parameterization is required for this in the rocker assignment. The labeling is therefore basically identical for all sub-functions on all rockers. If the labeling of a rocker is to differ from the channel label, the labeling function (see below) must be used.

An overview of the screen layout of the rockers is shown below.

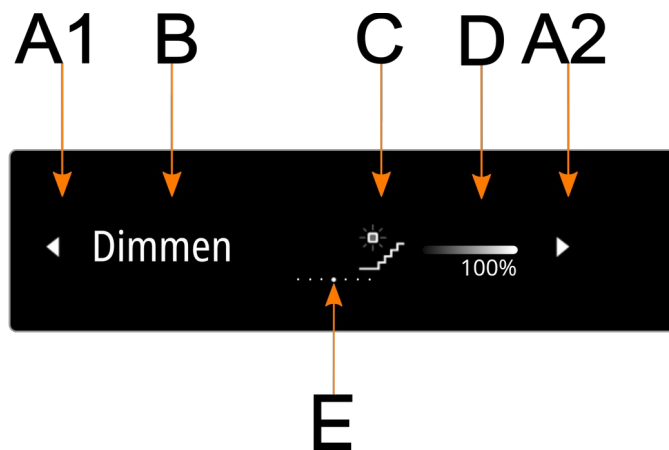

Figure 9: Rocker display in the standard rocker display when dimming

If the display does not require feedback D, this is omitted as shown in figure 10.

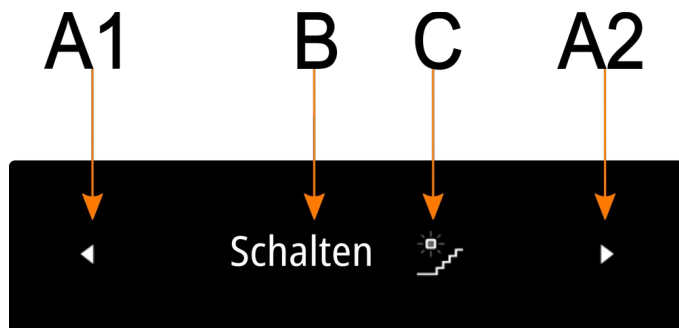

Figure 10: Rocker display in the rocker display Centered switching

The alternative display without feedback D with left-right alignment is shown in figure 11.

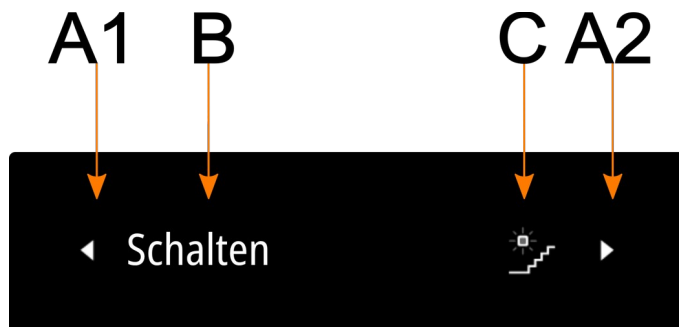

Figure 11: Rocker display in the rocker display Standard switching

The representation as a single push-button is shown as follows in figure 12:

- C: Feedback icon
- B Label
- D Feedback (for dimmers as a round dot corresponding to the brightness, for values the value display)

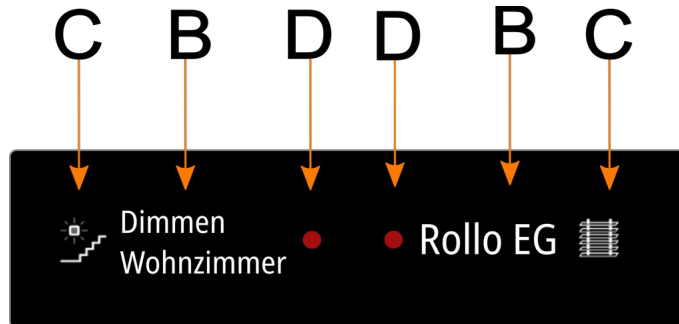

Figure 12: Single button display

Rocker operation and single button operation

A channel can be assigned so that it occupies either the entire rocker (figure 11) or only half of it (individual button, figure 12). There is usually a complementary function for a channel operation, e.g. switching on and switching off, dimming brighter and dimming darker, blinds up and blinds down, etc.

It is therefore possible to specify for the rocker which operation is to be assigned to the left-hand-button. This automatically assigns the other operation to the right-hand side.

For the single button operation, you can specify which operation is to be assigned to the button: Either that of the left rocker operation, the right rocker operation or alternating between the two.

Icon families

To make parameterization easier, the ETS application offers icon families. These represent an icon in various forms, e.g. two icons for On and Off, or families that recognize six intermediate states. The use of a family allows the firmware to automatically select, for example, the icon adapted for the feedback, e.g. denser light beams from the lamp in figure 11. This makes it easy for the user to graphically distinguish the feedback, e.g. 60% from 40%.

Operating icons

Icon families are also available for selecting the operating icons (A1/A2), e.g. in figure 11 the "Arrows left right small" family. The arrangement in the ETS with the polarity *Left<Right* can be specified separately, i.e. whether in the example in figure 11 the arrows are oriented outwards or inwards. If the family has several states, the minimum state is shown on the left and the maximum state on the right (if the default polarity *Left<Right* is selected).

Depending on the (channel) function, an individual selection can also be made for the left (A1) or right (A2) operating icon.

Feedback icon

Icon families for the feedback messages (C) can also be selected. Depending on the (channel) function, the feedback icon can also be determined directly from the operating icons. In both cases, the displayed status of the feedback is always adjusted automatically.

Overlaps

The firmware does not check to what extent the rocker label overlaps, e.g. in the single button operating mode in figure 12 occur. This means that the labeling can "protrude" into the other half of the rocker, i.e. possibly cover the label there. It is up to the user to check that this overlap does not occur. The fact that it is then possible for the labeling to protrude to the left or right of the other side gives the user more design options for the rocker label.

Label displays

Label displays can be used to make the label (B) of the rockers or individual buttons more flexible. A label display overwrites the labeling that results from the channel label. With the help of COs, this can be controlled and dynamized via the bus. Alternatively, the label display can overwrite a static label (B). When restarting, the static label is always active, previous labeling via COs is reset.

Assigning the label display also overwrites the default font size and the single or double line property. If the CO of the label display are linked, the labeling of the correspondingly linked rocker is updated. If the label is parameterized with two lines, the label is updated for each line according to the CO designation. With single-line parameterization, the two COs are displayed in a row. The characters are displayed according to UTF-8 coding. In this way, both longer character strings and all characters of the font family available in the device can be displayed.

All Western European and Eastern European fonts as well as Cyrillic, Greek and Arabic fonts are available as font families. These usually require 2 bytes per character. To send these dynamically via KNX (e.g. multimedia displays), we recommend a powerful logic engine such as the Enerterx EibPC², which can send the data encoded accordingly.

Examples

The function is helpful in conjunction with the use of sub-functions. An example of this is the channel label of an RGB channel that is parameterized as "Living room". The *Standard* sub-function is assigned to a rocker for changing the brightness of the light source (e.g. an RGB actuator such as the Enerterx Dimmsequenzer). If the user wants "Living room" + "Saturation" to be displayed on two lines in the rocker label when adjusting the saturation of the colored light control - with the *saturation sub-function* - this can be achieved by assigning a correspondingly configured label display.

Event messages

The event message is another possible function for the rocker assignment. The event function consists of ten events, characterized by bus activity of 1 bit communication objects (edge- or level-controlled). Each event can be assigned a 28-character message text in the application (less for special characters according to UTF-8 coding). When the event occurs, a time stamp is saved in the device, which can be displayed together with the message text on the rocker or the Premium display.

The memory for the event message is therefore intended for 10 messages including a time stamp. If you assign these to a rocker, you can scroll with the rocker operation: Pressing the left rocker button scrolls to older events, while pressing the right rocker button scrolls to more recent events. If you reach the current end, an arrow pointing to the left appears on the right (figure 13). To view the events on the Premium display, see Event messages below.

Four event messages, each with 10 events, are available to the user. These can be assigned once or several times to rockers and the premium display. When assigning a rocker, it is only possible to use the rocker as a whole for this purpose.

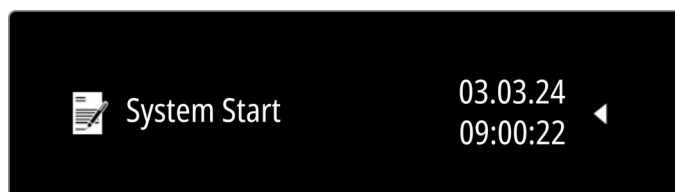

Figure 13: Event message

Alarms

The user can output up to 6 alarm messages to the rocker displays or the premium display. Like the event messages, these are dependent on a 1 bit CO (edge- or level-controlled) or its bus activity. It can be parameterized whether the alarm is accompanied by a sound (time-limited).

The display on a rocker is shown in figure 14. In the event of an alarm message, the correspondingly parameterized rocker of the current page displays the alarm, regardless of the page. If, for example, rocker 3 is assigned to the alarm message, this message will always appear there,

depending on the parameterization for a certain time or until the message is acknowledged.



Figure 14: Alarm

If the display is in sleep mode, it will wake up and show the alarm message.

If any button is pressed, all alarms are always acknowledged and no longer shown on the display.

Note 1:

During acoustic output, the screen brightness is reduced in order to limit the power consumption of the entire device.

Note 2:

The alarm messages are deleted after a restart.

Note 3:

If an alarm is already active on the rocker, the alarm message is suppressed.

Info displays

Info displays are value or text displays with symbols consisting of a maximum of five sub-displays. The displays of the (channel) functions can be partially overwritten to show info displays. In this case, the actual rocker or single button operation is retained. With rocker operation, the operating icons (A1/A2) are still visible, with single buttons the feedback icons (C) (see figures 9-12). It can be parameterized in the application whether the actual labelling B,C,D (or B, D for individual buttons) becomes visible again when approached. For this purpose, the integrated radar sensor is parameterized as a trigger.

An info display can consist of a main display with up to four secondary displays. The main display changes either when the other entries are visible (figure 15) or is only visible individually (figure 18). In addition, the info display can also be configured to be purely static, so that it appears like figure 15 but prevents the various values from changing.

The time is always displayed in maximum font size if this is the main display. The smaller fonts for the secondary displays at the bottom of the rocker or on the premium display are slightly darkened.

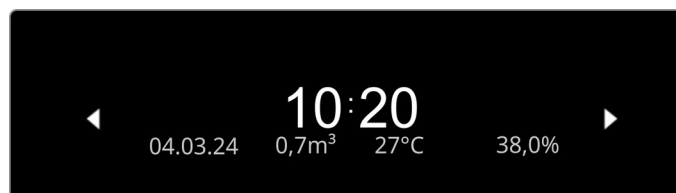

Figure 15: Time display with visibility of all entries



Figure 16: Display with text with visibility of all entries

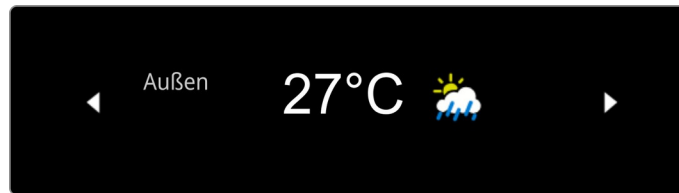

Figure 17: Display with text, icon
(Icon only visible if only one display is active)

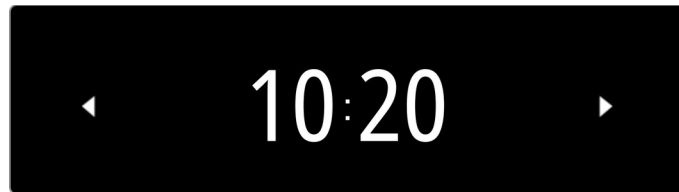

Figure 18: Time display

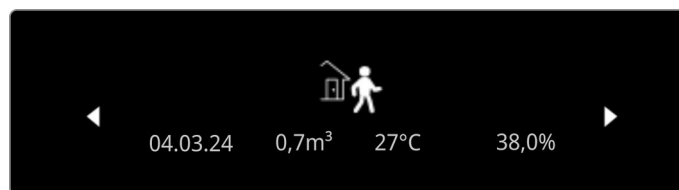

Figure 19: Controller display

In addition, the information display can be assigned to a rocker switch that itself has no (channel) function. In this case, the rocker switch operation or the individual button operation remains without any further function and no icons (A1/A2) or (C) are displayed.

As shown in figure 17, if you select „show one alternately“, the info display can show both text and an icon.

From ETS application V2.3, the controller display is also available. If the info display is placed on the premium display, the displays are shown from page 20.

Premium display

Overview

In addition to the rocker displays, the premium version has a further display with a resolution of 320x170, referred to below and in the application as the premium display. The premium display can be used to flexibly visualize various types of information in a way that is easily visible to the user. Standard displays here are the Info display (S. 20).

Daneben sind

- Event messages
- Alarm messages
- Solar display
- Weather info
- Three-line info display

as further alternatives. The last active message overwrites the previous one if it has not been deactivated again via an acknowledgement or an automatic fallback.

Although rocker displays and premium displays use the same technology and their backlighting is coordinated, a difference in brightness may be noticeable depending on the viewing angle. This can be compensated for using the application. The basic setting is optimized for 0° (direct top view).

Info display

The Premium display always shows one of the four possible info displays (see Info displays for rockers). A parameterized info display can be assigned to (several) rockers and premium display at the same time.



Figure 20: Premium display with date display

An assignment with alternating displays or several static displays is shown here as in figure 21. The language of the message adapts to the language selected in the ETS, in particular the days of the week and the month designation.



Figure 21: Premium display with date display and other displays

As show in figure 22, the operating mode of the controller is shown in the middle (B). From ETS application V2.3 onwards, it is possible to alternatively select whether the operating mode of a controller extension unit should be displayed here. Next to it is the output of the control variable or the 2-point controller, followed by the output of the fan control. (C) visualizes the weather info. The text (A) is partly context-related and is generated automatically depending on the language setting. The icon (U) can be set by the user via CO 10. The assignment of the CO values to the icon can be found on the following pages 44.

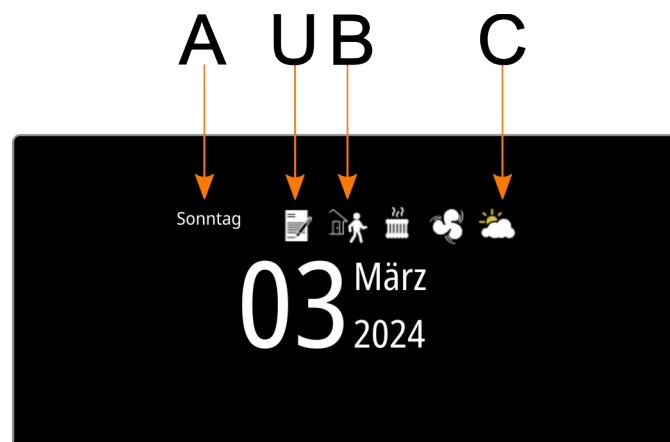

Figure 22: Premium display icons and info text

From ETS application V2.3, the controller display is also available. This shows details of the current status of the controller in the MeTa². It shows:

- the current operating mode (R1),

- the output of the control value (R2),
- the output of the control variable of the additional controller (R3),
- the setpoint temperature (R4)
- the operating mode of the controller heating or cooling (R5)
- the actual temperature supplied to the controller (R6) including all scaling and mean value calculations with values e.g. from additional sensors.

If the controller has fan control active, then:

- the icon for the ventilation (R5),
- the fan level (R6)

is displayed.

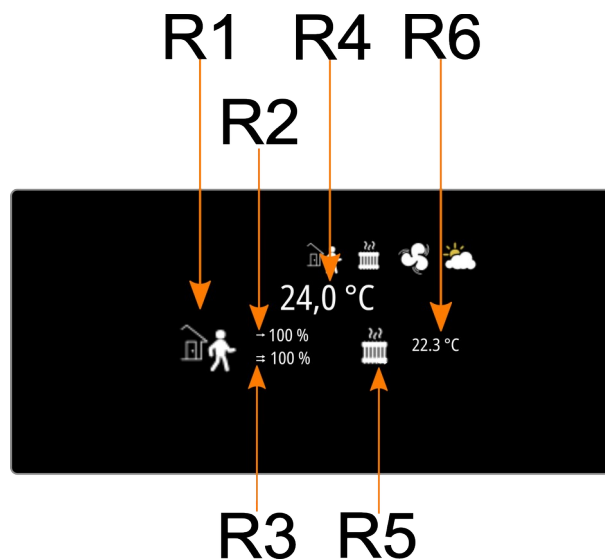

Figure 23: Premium display with info for controller display

Event messages

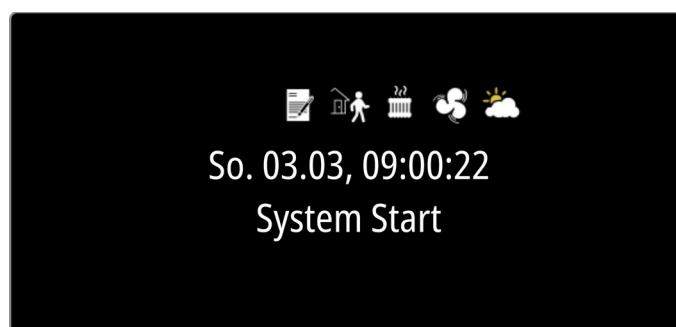

Figure 24: Premium display event message

A message appears on the Premium display in the form of figure 24 in two lines with a time stamp. Only the last message is shown when it arrives. The ETS application can be used to set whether the message only remains displayed for a certain time or until any operation of the rockers.

The language of the timestamp adapts to the language selected in the ETS.

Alarm messages

As explained above, the user can display up to 6 alarm messages on the premium display, whereby the last triggered message is always active. If the display is in sleep mode, it is woken up

and shows the alarm message. Depending on the parameterization, the message is displayed for a certain time or until it is acknowledged.



Abbildung 25: Premium display alarm message

Solar display

The Premium display offers visualization of a solar system in the home, as shown in 26. Button operation is available for this function so that the user can control the display of the data via the rockers. The display can remain switched on until the next button is pressed or return to the standard info display after a parameterizable fallback time. Green arrows always indicate energy generation or internal energy feed-in (e.g. from the battery storage system). Red arrows indicate consumption. The house symbol (2nd from the right in figure 26), green and red arrows are possible at the same time. The green arrow is the current PV yield, the red arrow is the current consumption in the house without battery and car charging power.

The values of the COs are signed and the counting direction is defined via the application. The default is the consumer metering system, in which consumption is shown as positive and generation as negative.

The green arrow is the current PV yield, the red arrow is the current consumption in the house without battery and car charging power.

Charging the battery is shown with a green arrow and discharging with a red arrow.

When charging the car, the red arrow indicates that the car is being charged.

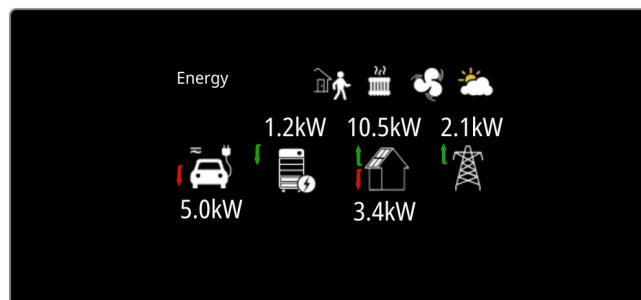

Figure 26: Premium display solar system

Note:

The necessary measurement data must be made available via the KNX bus. For recording power and currents, we recommend the Enertex® KNX SmartMeter, which records the total consumption with a high degree of accuracy. We recommend the Enertex® EibPC² for reading out the inverter data and controlling the wallbox or reading out the battery storage.

Weather info

The premium display offers the visualization of a weather info, as is possible, for example, via Internet queries and KNX-based, IoT-capable servers. We recommend the Enertex® EibPC² for this. If the COs are linked accordingly, the display of figure 27 is displayed. The language of the weather display adapts to the language of the ETS setting. The exact description of the COs can be found in the section Communication objects.



Figure 27: Premium display weather info

Three-line info display

The Premium display also offers the option of a three-line display that can be labeled via communication objects on the KNX bus. Another CO 269 is used to initiate the display, which is parameterized with a fallback time. Figure 28 shows this display in detail. CO 269 resets the fallback time each time the value 1 is received.



Figure 28: Premium display three-line display

Signal tone

The MeTa² has a built-in piezo buzzer. In addition to the sound output for the alarm, further signal tones can be triggered in two volumes using CO.

During the acoustic output, the screen brightness is reduced in order to limit the power consumption of the entire device. If several beeps are triggered simultaneously (within 1 second), the CO with the largest index is the one that will be active.

The tones are structured as follows:

- Signal tone 1: constant tone with two interruptions per second, similar to a busy signal on a landline telephone
- Beep 2: Alternating pitches with two smooth transitions from high to low and low to high twice per second
- Beep 3: Chirp sound in the style of an 80s jump & run game
- Alarm: Sound changes from low to high, similar to the red alarm in the "Star Trek" series

Inputs

The MeTa² is equipped with two inputs on the back. These can be used either as a binary input, e.g. for evaluating a window contact, or for evaluating the button operation of a conventional push-button. The edge evaluation can be configured for this in the application. Any potential-free installation switch is suitable as an external switching contact for the binary input. The switching voltage is provided by the room controller. Enertex® Bayern GmbH offers an **AluRa** frame program for the 55 series from Albrecht JUNG GmbH. These are available in three surface variants (brushed aluminium, black anodized aluminium and white powder-coated aluminium). Each of the color variants is available in single, double and triple versions. Double means that two 55

mm inserts can be installed in the frame, triple means that three inserts can be installed.

Enertex® AluRa – single, black anodized	1178-1-sw
Enertex® AluRa – single, white powder-coated	1178-1-ws
Enertex® AluRa – double, Al brushed	1178-2-al
Enertex® AluRa – double, black anodized	1178-2-sw
Enertex® AluRa – double, white powder-coated	1178-2-ws
Enertex® AluRa – triple, Al brushed	1178-3-al
Enertex® AluRa – triple, black anodized	1178-3-sw
Enertex® AluRa – triple, white powder-coated	1178-3-ws

Table 1: Order designation AluRa

Alternatively, each of the inputs can also be used to evaluate the measurement for an external temperature sensor. The value determined in this way can be used for the temperature measurement of the controller or made available to other devices via CO. The remote sensor from JUNG with the article number FF NTC is suitable for external temperature measurement.

The parameters and their explanations can be found in the application description of the ETS (see note on page 5, section Parameter description in the ETS).

Motion detector

Display control

The MeTa² is equipped with a motion detector that works on the radar principle. This can be used as a conventional motion detector to detect moving persons and can be parameterized (additionally or exclusively) to control the display switch-off or the display of information messages when approaching. If the COs and parameters of the motion detector are not enabled under General enable, the display switch-off or fade-in can still be used without additional parameterization.

If you want to deactivate the radar sensor completely, this can only be done by reducing the transmission power to 0% in the parameter area of the motion detector. This also deactivates the functions mentioned with regard to switching off the display and showing information displays.

Zone detection

The motion detector distinguishes between 3 radial zones. If the radar power is reduced below 100 % (default value), the range of the radar is reduced or the ranges of the individual zones are shortened accordingly. In addition, motion detection can be linked to the ambient brightness so that motion detection is no longer reported above a (configurable) brightness level. For each of the individual zones, a time constant for the fall-back can be configured separately for the signaling CO. However, an additional dead time after the fall-back until renewed detection is effective for all zones together. This does not affect the link with the display switch-off or the fading in of the info displays.

Mutual interference between multiple radar-based motion detectors operating within the same detection area must be prevented. If, for example, an Enertex MeTa² KNX and an Enertex ViTa KNX are installed in the same room, they must be configured to operate in different detection zones. This is achieved by setting the radar frequency to one of 5 available frequency bands. The sensor detection range remains unaffected.

The zones are divided into short, medium and long range. The near range is approx. 30 cm, the middle range approx. 1 m and the far range up to 3 m. The zones are to be understood as radial hemispheres around the installation location of the MeTa². If the long range is permanently active, the transmission power must be reduced. If the close range becomes active, the medium

range and the long range also become active automatically; if the medium range becomes active, the long range also becomes active.

Note:

Reducing the transmission power by half decreases the detection range of each zone to approximately one quarter.

Measured variables

Temperature measurement

The MeTa² has an integrated temperature sensor that can be used to measure the room temperature. The inherent heat of the appliance is compensated for. Compensation takes several minutes after a cold start. After a warm start or a very short power cut, the compensation is immediately in the steady state. Once the sensor has reached this state, the dynamic range of the temperature measurements is 1 to 3 seconds.

A second option for room temperature measurement is via an external sensor, for example another push-button sensor that also has a temperature sensor. Alternatively, one or two hard-wired remote sensors for temperature detection can be connected to the device, e.g. if the room temperature controller is installed in an unfavorable location or under difficult operating conditions (e.g. in damp rooms) or additionally (e.g. in large rooms or halls). In total, the device therefore offers three methods for room temperature measurement, which can also run in parallel.

In the application, a temperature can be determined via a free weighting of the individual measurements, which serves as an input variable for the controller. The weighting is standardized so that the sum of all individual weights is related to 1.0. The measurements of the MeTa² can also be offset.

The temperature shown on the device via the info display is this averaged temperature, which serves as an input variable for the controller.

The individual measured values can be output directly to the bus via separate COs. The parameters are used to specify whether this takes place cyclically and/or on change.

Humidity measurement

The MeTa² has an integrated humidity sensor. The air is a mixture of various gases, including water vapor. The amount of water vapor contained in the air is limited. Basically, the warmer the air is, the more water vapor it can contain.

The relative humidity measured by the sensor **indicates** what percentage of the maximum water vapor content the air currently contains. As the maximum water vapor content increases with rising temperature, the relative humidity decreases with rising temperature (and vice versa). Therefore, when measuring the air humidity (= relative humidity), it must be noted that after a cold start, the measurement of the temperature shows a transient process or the measurement of the temperature must calculate out the intrinsic heat. This compensation of the intrinsic heat takes several minutes after a cold start, so it takes this time for the humidity measurement to provide more accurate values. Once the sensor has reached this state, the dynamics of the humidity measurement are in the range 5..10 seconds.

The measured values can be output directly to the bus via separate COs. The parameters are used to specify whether this takes place cyclically and/or in the event of a change. A threshold alarm with hysteresis can also be used to monitor the value.

Dew point

The MeTa² calculates the dew point. The dew point is defined as the temperature at which the current water vapor content in the air is the maximum (100% relative humidity). The dew point, also known as the dew point temperature, is therefore the temperature at which the moisture contained in a volume of air condenses and forms a film of water (dew) on solid surfaces when the volume of air cools down at constant pressure. As an approximation, the dew point is calcu-

lated in MeTa² using the approximation given in https://en.wikipedia.org/wiki/Dew_point.

Light sensor

The MeTa² devices are equipped with a light sensor. This is located on the top behind the aluminum front and measures the brightness at this point. The measurement is not calibrated and is only qualitative. When measuring the brightness of a room, there is in principle no "one" brightness. This depends on various influences such as installation location, furniture, installation of lights, etc. The unit of the sensor is specified in lux. The illuminance is 1 lux when a luminous flux of 1 lumen is evenly distributed over an area of 1 m². The difference between lumen and lux is that lux takes into account the area over which the luminous flux (lumen) is distributed. A candle has about 12 lumens of brightness; at a distance of 1 meter, this results in a value of about 1 lux.

With the help of this sensor, the MeTa² will automatically adjust the display brightness of the rockers. This is also possible if the brightness communication is not enabled via CO on the bus.

Time display

The device has a real-time clock that can be synchronized via the bus. COs are available to synchronize the clock on restart if this has been configured in the ETS application.

Controller

Temperature

The MeTa² is equipped with a comfort controller. This comprehensive controller can be parameterized in two stages, is able to control a fan coil actuator (fan) and offers numerous additional functions, such as forced mode, temperature drop detection, etc.

As described in chapter Temperature measurement, the controller can work with an internally measured temperature, with up to two additional remote sensors or their measured values, an external measurement (via CO) or a combination of these options.

If room temperature control is activated but temperature measurement is deactivated in the parameters, the controller will use the internally measured temperature for the measurement. If the room temperature control is activated, the temperature measurement is also activated, but no temperature measurement is actively used for the measurement in the parameters, the controller will also use the internally measured temperature for the measurement.

Heating and/or cooling

In the individual operating modes "Heating" or "Cooling" without an additional stage, the controller always works with only one control value, alternatively with two control values in the parameterized operating mode if the additional stage is enabled. Depending on the determined room temperature and the specified setpoint temperatures of the operating modes, the room temperature controller decides independently whether heating or cooling energy is required and calculates the actuating variable for the heating or cooling system.

In the "Heating and cooling" mixed operating mode, the controller is able to control heating and cooling systems. The switchover behavior of the operating modes can be specified with automatic switchover or via CO.

In the automatic case, a heating or cooling mode is automatically activated depending on the determined room temperature and the specified temperature base setpoint or the dead zone. If the room temperature is within the set dead zone, neither heating nor cooling takes place (both control variables = "0"). If the room temperature is higher than the temperature setpoint for cooling, cooling takes place. If the room temperature is lower than the temperature setpoint for heating, heating takes place. If the operating mode is switched over automatically, the information can be actively output to the bus via the "Heating/cooling switchover" object.

The dead zone only exists in the case of automatic changeover. Switchover via CO may be necessary, for example, if a one-pipe system (combined heating and cooling system) is to be used

for both heating and cooling.

To do this, the temperature of the medium in the one-pipe system must first be changed by the system control. The operating mode is then set via the object (cold water is often used for cooling in the one-pipe system in summer and hot water for heating in winter).

The behavior after the reset can be defined in the application, e.g. which operating mode is activated after a reset. Further explanations can be found in the context help of the application.

Depending on the set operating mode, separate objects can be used to signal whether the controller is currently requesting heating or cooling energy and is therefore either actively heating or cooling. As long as the control value for heating is $> "0"$, a "1" telegram is transmitted via the "Heating" message object. Only when the control value = "0" is the message telegram reset ("0" telegram is transmitted). The same applies to the message object for cooling.

Operating modes

The room temperature controller distinguishes between different operating modes. By activating these modes, it is possible, for example, to activate different temperature setpoints depending on the presence of a person, the status of the heating or cooling system, the time of day or the day of the week. A distinction is made between the following operating modes:

- Comfort
- Standby
- Night
- Building protection

Comfort

Comfort mode is usually activated when there are people in a room and the room temperature needs to be set to a comfortable and appropriate value for this reason. Switching to this operating mode can be done by specifying an operating mode via the operating mode switchover.

Standby

If a room is not in use during the day because people are absent, standby mode can be activated. This allows the room temperature to be set to a standby value, thus saving heating or cooling energy.

Night

During the night or when you are away for long periods, it is usually advisable to set the room temperature to cooler temperatures for heating systems (e.g. in bedrooms). In this case, cooling systems can be set to higher temperature values if air conditioning is not required (e.g. in offices). Night mode can be activated for this purpose.

Building protection

Frost protection is required if, for example, the room temperature must not fall below critical values when the window is open. Heat protection may be required if the temperature in an environment that is usually always warm due to external influences becomes too high. In these cases, freezing or overheating of the room can be prevented by activating the building protection depending on the set operating mode "Heating" or "Cooling" by specifying a separate temperature setpoint value.

Operating mode

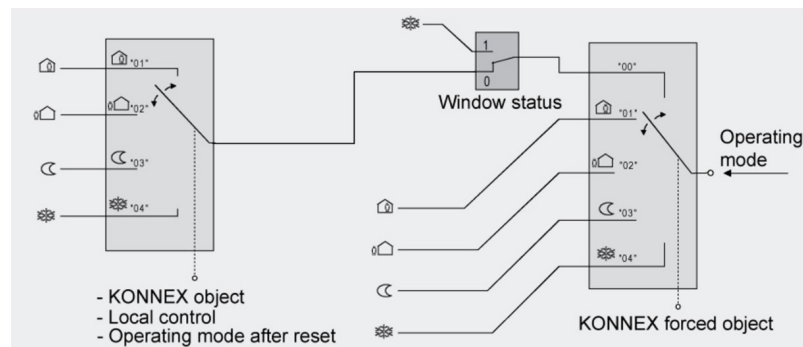

Figure 29: Overview of operating mode adjustment

The operating mode is switched as shown in figure 29 either

1. directly on the device
2. through COs
3. by a window contact or temperature drop detection (see below)
4. through the forced object

The forced object is used, for example, to ensure that adjustments to the device or a non-functioning window contact do not have an undesirable effect on the operating mode when a building needs to be heated up.

The adjustment on the device can be parameterized so that the user can only set a subset of the operating modes, e.g. hiding the building protection.

A change via the object must always be enabled in the ETS by parameterizing the corresponding parameters (see context help in the application).

Setpoints and operating modes

The controller has separate setpoints for each operating mode. If you follow the KNX design guidelines, these are all dependent on the base setpoint (see figure 30). This dependency makes it possible for the controller to switch between heating and cooling independently, since each setpoint can be clearly assigned as “too warm” or “too cold”.

However, this seems to cause problems of understanding for end customers, and it is not absolutely necessary when switching manually (between heating and cooling).

Therefore, both the controller and the controller's extensions support

- setpoints dependent on the base setpoint and adjustment via setpoint shift, referred to in the following section as “setpoint shift”,
- independent setpoints for comfort, standby and night operation and adjustment via absolute value specifications, referred to in the following section as “independent setpoints”

The mode is selected using the parameter Type of setpoint.

Setpoint shift

The controller has separate setpoints for each operating mode, all of which are dependent on the basic setpoint. Standby heating and night heating are each to be understood as relative values to comfort mode. The adjustment always has a reducing effect on the setpoint temperature. This means that night mode/standby mode for heating always has a lower (or at most the same) setpoint temperature as comfort mode (see figure 30).

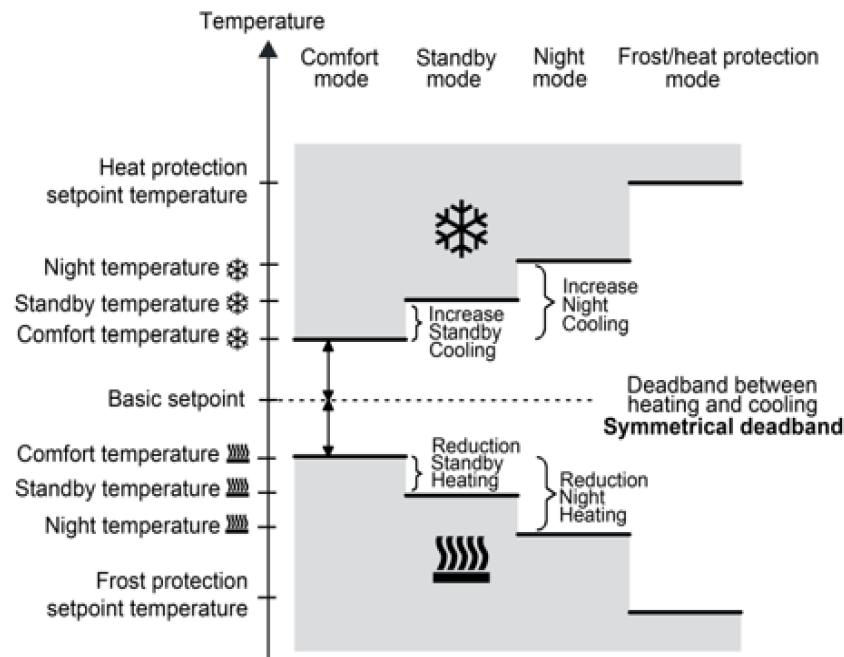

Figure 30: Overview of temperature adjustment in the controller

If standby or night mode is activated during heating, the corresponding setpoint can be changed directly on the device using the rocker adjustment. This does not change the basic setpoint temperature but the setback value. This changes the setback between comfort mode (basic setpoint temperature) and the activated operating mode. The upper limit of the standby temperature or night mode temperature is therefore specified by the comfort temperature. If the controller is in comfort mode, however, the rocker adjustment changes the basic setpoint.

The opposite is true for cooling: Here, specifying the night/standby adjustment always increases its setpoint temperature compared to the base setpoint (see figure 30).

If standby or night mode is activated for cooling, the corresponding setpoint for these modes can be changed directly on the appliance using the rocker adjustment of the temperature controller. This does not change the basic setpoint temperature, but the value of the increase. This changes the increase between comfort mode (basic setpoint temperature) and the activated operating mode. The lower limit of the standby temperature or night mode temperature is therefore specified by the comfort temperature. If the controller is in comfort mode, however, the rocker adjustment changes the basic setpoint.

In this way, the user can adjust all temperature limits directly on the device, whereby parameters in the application can be used to specify whether this adjustment is permanently adopted or only applies temporarily until the next operating mode is selected. It is also possible to specify whether setpoints, increases or decreases already changed by the user should be overwritten or retained when the ETS parameters are downloaded again.

Neither heating nor cooling takes place in the dead zone. If the controller only switches to heating or cooling or does not switch automatically, the dead zone does not exist.

The sizes shown in figure 30 are KNX standardized behaviour. All parameters can be adjusted accordingly using the MeTa² application. The basic setpoint can be shifted via the bus.

Independent setpoints

In this mode, the setpoints can be adjusted on the device and via CO 383 without any limitations. Automatic switching between heating and cooling is not possible.

Adjusting the setpoint on the device therefore only ever affects the current operating mode. The setpoint shift, on the other hand, also shifts all setpoints for all operating modes in this mode.

Controller type

Fundamentals

The room temperature controller enables either proportional/integral control (PI) as a continuous or switching version or alternatively a switching 2-point control. In some practical cases, it may be necessary to use more than one control algorithm. In larger systems with underfloor heating, for example, a control circuit that only controls the underfloor heating can be used for constant temperature control. The radiators on the wall, possibly even in an adjacent area of the room, are controlled independently by an additional stage with its own control algorithm. In these cases, it is necessary to differentiate between the controls, as underfloor heating systems usually require different control parameters than radiators on the wall. In two-stage heating or cooling mode, it is possible to configure up to four independent control algorithms.

The control values calculated by the control algorithm are output via the "Heating control value" or "Cooling control value" communication objects. The format of the control value objects is defined depending on the control algorithm selected for heating and/or cooling mode. For example, 1 bit or 1 byte control value objects can be created. The control algorithm is defined by the "Type of heating control" or "Type of cooling control" parameters in the "Room temperature control" parameter branch, possibly also with a distinction between the basic and additional stages.

PI controller

PI control is an algorithm that consists of a proportional (P) and an integral part (I). Both parts are added together to form an output signal. By combining these components, a fast and precise control of the room temperature is achieved with little or no control deviations. The room temperature controller calculates a new continuous control value and outputs it to the bus via a 1 byte value object if the calculated control value has changed by a specified percentage.

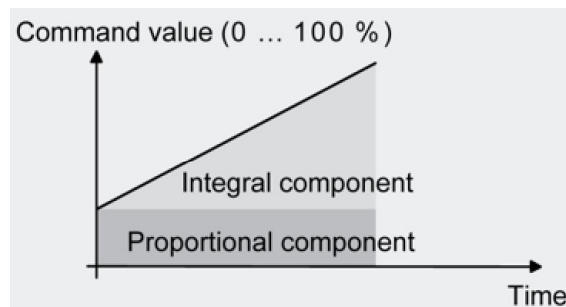

Figure 31: PI controller

The proportional factor P in K(elvin) is defined as follows:

If there is a temperature deviation of P (Kelvin), a value of 100% is fed to the controller output (depending on heating or cooling).

Example

$P=4K$. Actual temperature = 20°C, setpoint = 24°C. The result is $24^{\circ}C-20^{\circ}C = 4 K = P$. This supplies the controller output with an output variable of 100%.

The integral factor I (also readjustment time T_N) in min is defined as follows:

With a temperature deviation of 1 Kelvin over I minutes, the controller output is at 100%.

Example

$I=120K$. Actual temperature = 23°C, setpoint = 24°C. The result is $(24^{\circ}C-23^{\circ}C)/120 = 1K/120$. This means that an output variable of 100% is fed to the controller output after 120 minutes.

An optimally set PI controller is the standard procedure for a perfect heating or cooling experience. The PI controller balances the heating time constant of the room in such a way that the desired setpoint temperature is reached without overshoots (phases where it is too warm and then too cold again) and without it taking too long to reach the desired temperature value. If overshoots occur, P is set too high, if the time constants are too long, I is too high.

The parameters for P and I can be freely defined in the Enertex® MeTa² KNX room controller. Suitable parameters are already stored for typical applications.

PI controller with PWM output

The room temperature is also kept constant with this type of control by the PI control algorithm. Averaged over time, the behavior of the control system is the same as with a PI controller. The difference to PI control lies exclusively in the control variable output. The control value calculated by the algorithm is converted internally into an equivalent pulse width modulated (PWM) control value signal and output to the bus via a 1 bit switching object after the cycle time has elapsed. The mean value of the actuating variable signal resulting from this modulation is a measure of the averaged valve position of the control valve and therefore a reference for the set room temperature.

A shift in the mean value and thus a change in the heating output is achieved by changing the duty cycle of the switch-on and switch-off pulse of the actuating variable signal. The duty cycle is only adjusted by the controller at the end of a time period, depending on the calculated actuating variable. Every change in the manipulated variable is implemented, regardless of the ratio by which the manipulated variable changes. The last control value calculated in an active time period is converted. Even if the setpoint temperature is changed, for example by switching the operating mode, the actuating value is only adjusted at the end of an active cycle time. The following illustration shows the output actuating variable switching signal as a function of the internally calculated actuating variable value (initially 30 %, then 50 % manipulated variable; manipulated variable output not inverted).

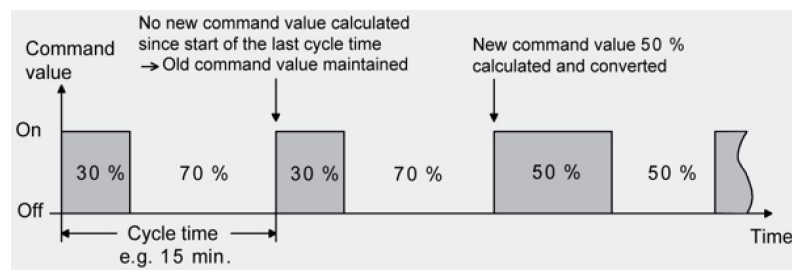

Figure 32: PI with PWM output

Cycle time:

In most cases, the pulse width modulated actuating variables are used to control electrothermal drives (ETA). The room temperature controller sends the switching actuating variables telegrams to an actuator with semiconductor switching elements to which the drives are connected (e.g. heating actuator). By setting the cycle time of the PWM signal on the controller, it is possible to adapt the control to the drives used. The cycle time defines the switching frequency of the pulse width modulated signal and allows adaptation to the adjustment cycle times of the actuators used (travel time required by the actuator to adjust the valve from the fully closed position to the fully open position). In addition to the adjustment cycle time, the dead time (time during which the actuators show no reaction when switching on or off) must also be taken into account. If different actuators with different adjustment cycle times are used, the longer of the times must be taken into account. Basically, two cases can be distinguished when configuring the cycle time:

Case 1

Cycle time > 2 x adjustment cycle time of the electrothermal actuators used (ETA)

In this case, the switch-on or switch-off times of the PWM signal are so long that the drives have sufficient time to fully open or close in one time period.

Advantages:

The desired mean value for the control value and thus the required room temperature is set relatively accurately, even if several drives are controlled simultaneously.

Disadvantages:

It should be noted that the life expectancy of the drives may be reduced due to the full valve stroke that must be constantly "run through". With very long cycle times (> 15 minutes) and a lower inertia of the system, the heat output to the room near the radiators may be uneven and be perceived as disturbing.

- This cycle time setting is recommended for slow heating systems (e.g. underfloor heating).
- This setting should also be used for a larger number of possibly different actuators.

to ensure that the travel paths of the valves can be better averaged.

Case 2

Cycle time < adjustment cycle time of the electrothermal actuators (ETA) used

In this case, the switch-on or switch-off times of the PWM signal are so short that the drives do not have sufficient time to fully open or close in one period.

Advantages:

This setting ensures a continuous flow of water through the radiators and thus enables a uniform heat output to the room. If only one actuator is controlled, it is possible for the controller to compensate for the mean value shift caused by the short cycle time by continuously adjusting the control value and thus set the desired room temperature.

Disadvantages:

If more than one actuator is controlled simultaneously, the desired mean value for the control value and therefore the required room temperature is only set very poorly or with large deviations. Due to the continuous flow of water through the valve and thus the constant heating of the actuator, the dead times of the actuators change during the opening and closing phases. Due to the short cycle time, taking into account the dead times, the required control value (mean value) is only set with a possibly larger deviation. To ensure that the room temperature can be set constantly after a certain time, the controller must compensate for the mean value shift caused by the short cycle time by continuously adjusting the control value. The control algorithm implemented in the controller (PI control) usually ensures that control deviations are compensated for. This setting for the cycle time is recommended for fast-responding heating systems (e.g. panel radiators).

Two-Point controller

Two-Point control is a very simple type of temperature control. With this control, two hysteresis temperature values are specified. The actuators are controlled by the controller via switch-on and switch-off actuating variable commands (1 bit). A continuous actuating variable is not calculated with this type of control.

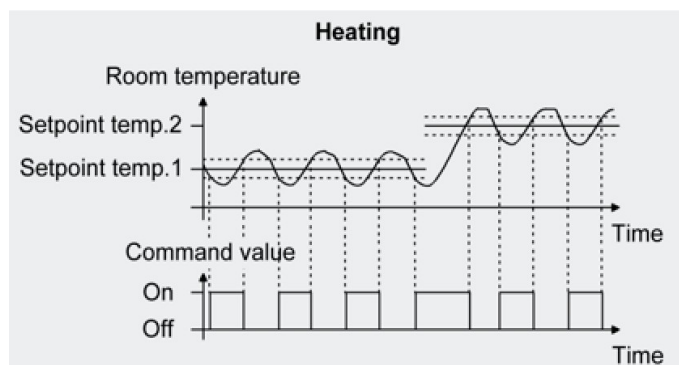

Figure 33: Two-point controller for heating

No fast-acting heating or cooling systems should be controlled by a Two-Point control, as this can lead to a very strong overshoot of the temperature and thus to a loss of comfort. When defining the hysteresis limit values, a distinction must also be made between the operating modes.

As the MeTa² can handle the "better" PI controller, it is recommended to use it for heating and cooling.

Additional levels

In addition to the controller for heating and cooling, the MeTa² has two further controllers for additional heating and additional cooling. These can be set separately from the basic level according to the settings already described in Controller type and can be parameterized accordingly.

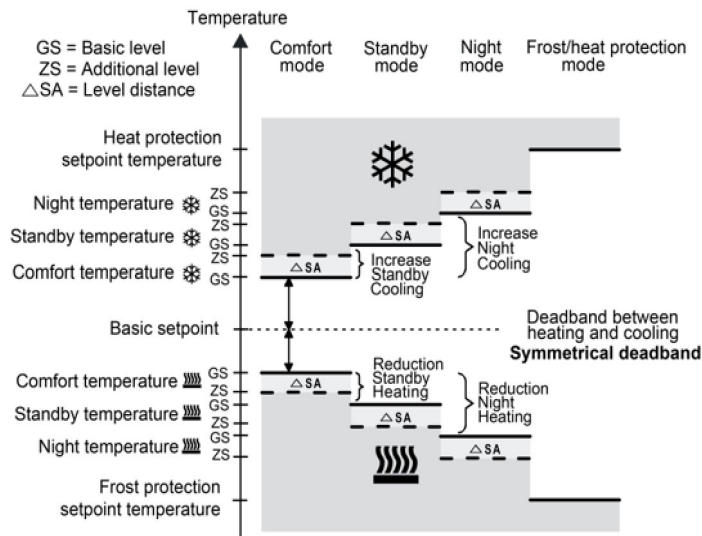

Figure 34: Setpoint temperatures for additional stages

Figure 34 shows the basic dependencies. The additional stage always has a further temperature difference to the basic stage, which is constant for heating and cooling. This can be set separately for heating and cooling in the application. The stage interval ΔSA can be set differently for heating and cooling.

If the basic setpoint or the reduction or increase of the standby/night temperatures change, the corresponding setpoints of the additional stages also change. The operating mode of the additional stages is basically identical to the basic stage.

Fan control

FanCoil

Fan control can be added to the room temperature control. In this way, it is possible to control the fan of circulating air-operated heating or cooling systems, such as fan coil units, depending on the control value calculated in the controller or by manual operation. The fan control must be enabled separately if required.

Fan coil units usually have multi-stage fans that can be varied in speed and therefore in ventilation performance via fan stage inputs. For this reason, the fan control of the room temperature controller supports up to 3 fan speed outputs, whereby the actual number of speeds used (1 to 3) can be set. The controller controls the stages of a fan via bus telegrams. For this purpose, the control value of the controller output is converted into a control value for the fan. In the application, you can specify which control value corresponds to which fan speed. A hysteresis for this specification can also be parameterized there.

As a rule, the fan speed telegrams are received and evaluated by simple switching actuators. These actuators are then used to electrically control the fan speed inputs of a fan coil unit. Depending on the data format of the objects of the controlled actuators, the fan speed can be switched either via up to 3 separate 1 bit objects or alternatively via a 1 byte object.

Due to the inertia of a fan motor, the fan speeds cannot be switched at arbitrarily short intervals and the fan speed cannot vary as quickly as required. The technical information for a fan coil unit often specifies changeover times that the fan controller must adhere to for each fan speed changeover. The switching direction, i.e. increasing or decreasing the speed, is irrelevant. When switching via the 1 bit objects, the active fan speed is first switched off by the controller when the fan speed is changed before the new speed is switched on. If the fan controller is working in automatic mode, the adjustable "Waiting time on level switchover" is observed when the levels are switched. The fan speed objects are all set to "0 - Fan off" for this short period. A new level is only switched on when the waiting time has elapsed. Only one fan speed output is ever swit-

ched on (changeover principle). When switching via the 1 byte object, the fan level is switched directly to the new level without setting the "OFF" state. If the fan controller is working in automatic mode, the adjustable "Waiting time on level switchover" (dwell time) is always taken into account before the levels are switched over. In the case of a fast stage changeover, the fan is only switched to a new stage when the waiting time has elapsed. The control enables the parameterization of start-up behaviour, stop behaviour and transition control of the various fan stages (max. 3).

Split unit

The fan control can also be used for a combination of the MeTa² controller with a split unit air conditioner. A distinction can be made here as to whether this only applies to cooling, for example, because heating is provided by another system. In this case, the split unit can be controlled via the cooling 1 bit object so that it switches to the on state. The control value of the controller is transferred to this air conditioning unit via KNX so that the cooling capacity is provided accordingly. The fan control of the split unit air conditioning system is also specified by the controller via its fan control. This means that the complete temperature control remains with the MeTa² controller.

Split units often have the characteristic that they do not switch off the ventilation when 0% cooling is required. This only occurs if the entire air conditioning system is switched off. To make this possible, the controller provides an object that switches off the split unit completely at controller output 0%.

Rocker operation and sub-functions

The controller is operated by assigning the various sub-functions to the rockers in the Operation and icons tab of the controller. The icons for operation (A1/A2, see figure 9) can be changed by the user, the feedback icons (C) cannot.

There are the following sub-functions for assignment to rockers or single button operation with the following behavior:

1. Operating mode
Switching the operating mode (standby, night, comfort mode and building protection depending on the parameterization)
2. Setpoint shift
The controller setpoint temperature is adjusted depending on the active operating mode:
 - In comfort mode, this is the shift of the basic setpoint temperature, which therefore also influences all setpoints of the other operating modes.
 - In night mode, only the difference between this mode and the basic setpoint temperature is changed. As figure 30 shows, in heating mode the night mode setpoint temperature is always less than or equal to the comfort temperature. Therefore, adjustment in heating mode is only possible up to this temperature. Conversely, in cooling mode, the adjustment is less than or equal to the comfort temperature of cooling mode. Adjustment is therefore only possible up to this temperature.
 - In standby mode, only the difference between this mode and the basic setpoint temperature is changed. The same applies here: As figure 30 shows, in heating mode the setpoint temperature for standby mode is always less than or equal to the comfort temperature. Therefore, in heating mode, adjustment is only possible up to this temperature. Conversely, in cooling mode, the adjustment is less than or equal to the comfort temperature of cooling mode. Adjustment is therefore only possible up to this temperature.
3. On/Off
Switchover between heating and cooling. This function is only active if the controller is parameterized so that the switchover can be performed manually. Otherwise, only whether heating or cooling is active is displayed. In this case, it is advisable not to use the operating icons, as the buttons have no function.

4. Fan adjustment

This function can be used to adjust the fan speed via the rockers if this has been activated in the controller and the fan control is in manual mode. However, if the fan control is in automatic mode, the current active fan speed is displayed, but this cannot be adjusted using the rockers.

5. Fan Auto/Manual

This function can be used to switch between automatic and manual fan control mode or to display which mode is active.

Note

If the setpoint adjustment is only to represent a (relative) basic setpoint shift, this is possible either with a value adjuster for DPT9, or by parameterizing an extension unit, whereby the extension unit then accesses the main unit of the MeTa².

Controller extensions

The MeTa² can control up to four controller extensions. In contrast to the main unit, the controller extension does not send any control value telegrams. It only serves as an operating point for the controller in the main unit.

Main unit and extension unit

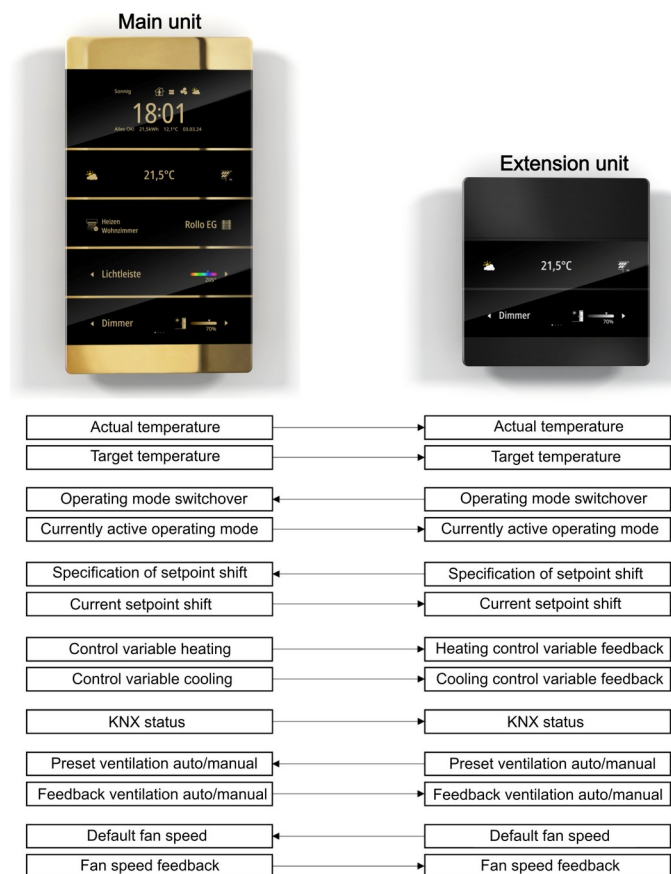

Figure 35: Extension unit and main unit

In other words, a controller extension is not involved in the temperature control itself. It gives the user the option of operating the individual room control, i.e. the main controller, from various locations in the room. In this way, any number of operating extensions can be set up. The controller extension can also be used to control central heating control units, which are located in a sub-distribution board, for example. Figure 35 shows the relationship between the COs of two

MeTa², one of which serves as the controller main unit and one as an extension unit. The MeTa² can also operate the fan speed control in the controller extension.

Rocker operation and sub-functions

The controller extension is operated by assigning the various sub-functions to the rockers in the Operation tab and icons of the extension. The icons for operation (A1/A2, see figure 9) can be changed by the user, the feedback icons (C) cannot.

The following sub-functions are available for assignment to rockers or single button operation with the following behavior:

1. Operating mode
Switching the operating mode (standby, night and comfort mode)
2. Setpoint shift
Setpoint shift of the basic setpoint temperature (effective for all operating modes equally)
3. On/Off
If the controller main unit has a switching function, this can be operated with it.
4. Fan adjustment
This function can be used to adjust or display the fan speed using the rockers.
5. Fan Auto/Manual
This function can be used to switch between automatic and manual fan control mode or to display which mode is active.

Split units (extensions)

Application

While central heating and cooling systems are mainly used in Central Europe, split units are often used in warmer regions. These consist of two parts: an indoor unit, the heat exchanger, and an outdoor unit, the compressor. The two units are connected to each other via a refrigerant line. In most cases, the volume flow of heat or cold is additionally regulated by a fan or fan control. In addition to heating and cooling, the split unit can also be controlled as a pure dryer for humidity or as a pure ventilation system. Few split units are directly KNX-capable. The more common case is that the split units are integrated into the KNX world via a special gateway.

The split unit function is available to the user in the MeTa² for such heating and cooling systems. The split unit assumes the function of a main controller. It determines the heating or cooling requirement from an input temperature. The user therefore basically operates the split unit with the MeTa², e.g. to adjust the setpoint temperature or the operating mode. Since, as mentioned at the beginning, there are other operating modes in addition to heating and cooling, the modes are switched in a slightly different way than with the controller extension unit. In addition, the split unit extension can control up to four fan stages.

The MeTa² can control up to four split units. The split units are often not directly equipped with a KNX interface, but are connected via a gateway. However, this is irrelevant or identical for the basic control via the MeTa².

Rocker operation und sub-functions

The controller extension is operated by assigning the various sub-functions to the rockers in the Operation and icons tab of the extension. The icons for operation (A1/A2, see figure 9) can be changed by the user, the feedback icons (C) cannot.

The following sub-functions are available for assignment to rockers or single button operation with the following behavior:

1. Operating mode
Switching the operating mode: heating, cooling, drying, ventilation

2. Setpoint shift
Setpoint shift of the basic setpoint temperature (effective for all operating modes equally)
3. On/Off
If the split unit has a switching function, this can be operated with it (e.g. on/off of the entire unit)
4. Fan adjustment
This function can be used to adjust or display the fan speed using the rockers.
5. Fan Auto/Manual
This function can be used to switch between automatic and manual fan control mode or to display which mode is active.

Logic function

The device contains up to 8 logic functions. These functions can be used to carry out simple logic operations in a KNX installation. Logic functions can be networked with each other by linking input and output objects.

Up to two time functions can be set independently of each other for each logic output. The time functions only affect the "Switching" communication objects and delay the received object value depending on the telegram polarity.

This means that in addition to pure logic, time sequences can also be controlled with the logic module.

Channel functions

Switching

Using a family for the feedback icon allows the firmware to automatically select the icon adapted for the feedback. The family can also be determined directly from the operating icons. The icon can also be completely suppressed.

The switching function can flexibly display operating icons A1/A2 and feedback icons C. In addition to the choice of assigning an icon family, it is also possible to select the icons individually.

Each channel can be assigned several times to a rocker or individual button; the switching statuses and feedback signals are updated uniformly in each case.

The switching function only recognizes the Standard sub-function. All other parameters for rocker assignment are therefore ignored and Standard is used.

Dimming

Absolute and relative dimming

The dimming channel function implements relative dimming with a feedback object.

Note

If you want to dim with absolute values, use the value transmitter.

Subfunctions

Dimming has three sub-functions for rocker or single-button operation with the following behavior:

1. Standard
A short press of the button sends ON or OFF to the switching channel. A long button press sends the parameterized relative dimming telegram. An optional stop telegram is sent at the end of operation (release).
This is also the sub-function that is implemented by the firmware if the ETS parameterization is invalid.

2. Dimming (On/Off)
Pressing the button sends ON or OFF to the switching channel
3. Dimming
Long button presses send the parameterized relative dimming telegram. An optional stop telegram is sent at the end of operation (release).

Icons

The operating icons can only be selected from the families. The polarity of the icons is adapted to the operation for the behavior when the left or right rocker button is pressed. The operation from one side of the rocker to the other is complementary.

Dimming Tuneable White

Absolute and relative colored light control

The colored light control (Tuneable White) can be used to control lamps that have both warm white and cool white light sources and are controlled by a suitable dimming actuator. The Ener-tex® KNX LED Dimmsequenzer 20A/5x is a highly optimized dimming actuator for low-voltage luminaires. The colored light control or change of the color value can be changed with a percentage value (relative) from 0 to 100% cold light component, or with the help of an absolute temperature value in Kelvin (16 bit).

The warm white light color (2000 to 3300 K) is often perceived by people as pleasantly calming. The cold white light color (from 6000 K) describes a white color spectrum with an increased blue component. This increased blue component makes the viewer feel more alert (see figure 36).

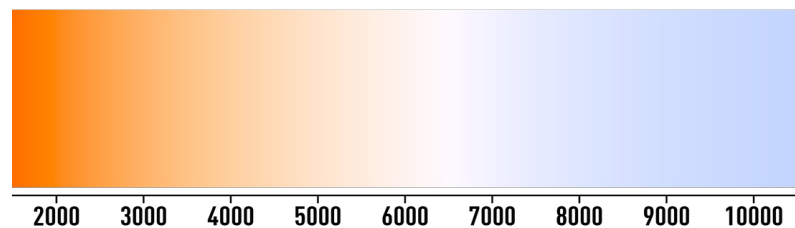

Figure 36: Color temperature in Kelvin
(Source: Wikipedia, License: CC BY-SA 4.0, permitted editing)

The MeTa² has implemented both methods for control.

Ener-tex® KNX LED Dimmsequenzer 20A/5x

The Ener-tex® KNX LED Dimmsequenzer 20A/5x offers a wide range of options for controlling LED light sources that are tailored to operation with the MeTa². The following notes therefore apply.

Note 1

The Ener-tex® KNX LED Dimmsequenzer 20A/5x offers the option of additionally spreading the achievable color tone of the light with RGB CCT light sources using the "Extended TW" mode (figure 37). In this case, the extended range for the upper and lower limits must be entered in the MeTa² application and not those of the cold white or warm white LED.

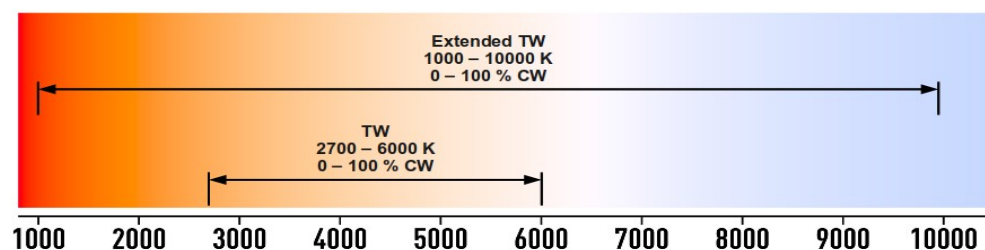

Figure 37: Example Extended-TW
(Source: Wikipedia, License: CC BY-SA 4.0, permitted editing)

Note 2

The Ewertex® KNX LED Dimmsequenzer 20A/5x offers the option of simulating the achievable color tone of the light with RGBW light sources as with a cold white/warm white LED combination using the "Extended TW" mode (figure 38). Enter the values selected in the dimming sequencer application in the MeTa² data to achieve an optimum dimming result.

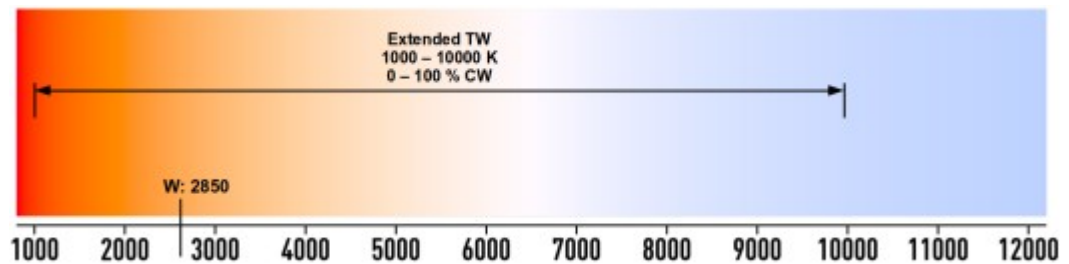

Figure 38: Example of simulated TW
(Source: Wikipedia, License: CC BY-SA 4.0, permitted editing)

Note 3

Regardless of the application of the "Extended TW" mode with corresponding COs for this control, the dimmer allows simultaneous use as RGB colored light control via the corresponding RGB CO or the feedback CO, e.g. for channel 1 CO 42 and CO 43.

Note 4

The Dim-2-Warm function can be used to simulate the dimming behavior of earlier halogen lamps, whose colour temperature shifts towards warm white as the brightness decreases. To do this, two points are defined with brightness and color temperature. In this case, the channel behaves like a simple dimming channel and must be parameterized accordingly.

Note: If Dim-2-Warm is activated, the color temperature cannot be adjusted in any other way using parameters or COs.

Subfunctions

Dimming Tuneable White has the following sub-functions for the rockers or individual button operation with the following behavior:

1. Standard
A short press of the button sends ON or OFF to the switching channel. A long push-button action changes the brightness value with an absolute dimming telegram. This is also the sub-function that is implemented by the firmware if the ETS parameterization is invalid.
2. Dimming (On/Off)
Pressing the button sends ON or OFF to the switching channel
3. Dimming
A long press of the button changes the brightness value with an absolute dimming telegram.
4. Color temperature
Dimming telegrams for color light control from warm white to cold white. The color values are always shown on the rocker display, even if the color light control is specified as a % cold light component.

RGB colored light control**RGB colors**

The MeTa² can also be used for RGB control of light sources with the entire color space display. A suitable actuator is required for color light control. The Ewertex® KNX LED Dimmsequenzer 20A/5x is a dimming actuator optimized for low-voltage lights (<48 V in LED technology) with outstanding possibilities for coloured light control. The RGB LED light sources are technically

composed of the three colors red-green-blue. They are controlled via an RGB object that outputs an intensity of 0 to 100% for each of the three colors. The resulting light color is made up of the three color channels. The use of HSV displays makes the setting quite simple for the user. The H value ("**Hue**", color angle) indicates the color or hue. The color angle is assigned to a color in the color wheel. Each angle value means a different color, e.g. 0° for red, 30° for orange, 60° for yellow, etc. The color transitions are fluid, see figure 39.

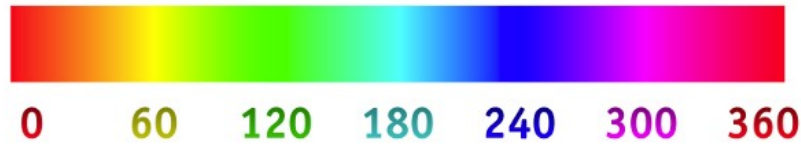

Bildquelle: [Wikipedia](#); gemeinfrei.

Figure 39: Color angle



Figure 40: Saturation (left edge S= 0%, right edge S=100%)

The S value (**saturation**) indicates the color saturation. S = 0% means white light and S = 100% means complete lighting in the set color tone only. "White" is to be understood in the context of the possibilities of the light source, because white light is only created by mixing the three colors. Figure 40 shows the saturation for a color angle of 240°. For other color angles, the basic tone is given by this color. The V value indicates the total brightness of the light source.

Enertex® KNX LED Dimmsequenzer 20A/5x

The Enertex® KNX LED Dimmsequenzer 20A/5x offers optimum control of RGB LED light sources that are matched to operation with the MeTa².

Especially with RGB light sources with one (RGBW) or two (RGBCCT) additional white channels, the lighting settings can be simplified for the user. The saturation of the light color or its "desaturation" (less color and more white component in the light) by the RGB operation only affects the RGB object. This achieves the "white" color tone by mixing the three colors. However, this white light is not always pleasant or sufficiently white for human perception. RGB light sources therefore offer an additional white LED channel (RGBW), which is adjusted by the manufacturer to a corresponding white light.

As conventional dimmers control the white channel separately, the user must also operate a dimming channel for the white light, even though they have already set the white component via the saturation. The dimming sequencer, on the other hand, allows the white channel to be dimmed directly to the desired white component via the "extended white balance" by setting the desaturation directly via the white channel only.

Subfunctions

In the rocker display, the sub-functions

1. Standard
A short press of the button sends ON or OFF to the switching channel
long pushchanges the absolute brightness value (0...100%).
This is also the sub-function that is implemented by the firmware if the ETS parameterization is invalid.
2. Dimming (On/Off)
Pressing the button sends ON or OFF to the switching channel
3. Dimming
Pressing and holding the buttonchanges the absolute brightness value (0...100%).
4. Saturation
Press and hold the button to change the absolute saturation value (0...100%).
5. Color value

Long keystroke changes the absolute value of the color (0...360°).

Note:

Only the resulting absolute 3 byte RGB object can be observed on the bus. This must be provided by every KNX dimmer in conformity with KNX. The conversion from HSV to RGB is done internally by the MeTa². The link to the RGB actuator is therefore always made via its 3 byte color object with DPT 232.600.

Roller shutter/Awning

Roller shutters or awnings are controlled via short-term and long-term operation. Long-term operation is the movement of the roller shutter/awning via a 1 bit CO for up and down, short-term operation stops the movement of the roller shutter/awning via a 1 bit CO (stop). The blind height is shown as feedback on the rocker display.

The application always sends the short time object for short button operation and the long time object for long operation. If the shutter/awning movement is to be controlled in reverse, the linking of the COs can simply be swapped.

The function only recognizes the Standard sub-function. All other parameterizations for the rocker assignment are therefore ignored and Standard is used. The feedback of the blind/shutter height is displayed in the rocker if the feedback OK is linked and the feedback is linked via an icon family.

Note:

If the actuator allows adjustment via an absolute specification of the position in percent, the value transmitter can alternatively be used for operation.

Blinds Operation

Blinds are controlled via short-term and long-term operation. Long-term operation is the movement of the blinds via a 1 bit CO for up and down, short-term operation stops the movement of the blinds via a 1 bit CO (stop), which simultaneously starts the slat adjustment. The blind height is shown as feedback on the rocker display. The slat position can be queried or displayed via another CO.

The application always sends the short time object for short button operation and the long time object for long operation. If the blind movement is to be controlled in reverse, the linking of the COs can simply be swapped.

Note:

If the actuator allows adjustment via an absolute specification of the position of the blind height and the slat position as a percentage, the value transmitter can alternatively be used for operation.

Subfunctions

In the rocker display, the sub-functions

1. Standard
Short button press sends ON or OFF to short-time operation.
long long-time operation. The feedback of the hanging height is displayed in the rocker if the feedback OK is linked and the feedback is linked via an icon family.
This is also the sub-function that is implemented by the firmware if the ETS parameterization is invalid.
2. Slat position
A short press of the button sends ON or OFF to short-time operation and the feedback of the slat position is displayed if the feedback OK is linked and the feedback is linked via an icon family.

Value provider

Data types

The value provider is the general form of adjusting values via the operation of the MeTa². The following data types are available

- 1 byte unsigned
0 ... 255, 0.. 100%, 0...360°
- 1 byte signed: -128... 127
- 2 byte unsigned: 0 ... 65365
- 2 byte signed: -32768 ... 32767
- 2 byte floating point
- 4 byte unsigned: 0 ... 4294967296
- 4 byte signed: -2147483648 ... 2147483647
- 4 byte floating point

available.

The value range of the adjustment can be limited and the increase or decrease can be specified separately for each button. The channel has an output OK for the value adjustment and an input OK for the feedback.

Note 1

With very large value ranges, a rounding error may occur if a very small increment is selected.

Note 2

The representation of the icon (see C in figure 10) becomes unfavorable in the standard display with large numbers and covers the icon. In this case, the icon should be omitted.

Scene extension

Scenes can be called up or saved using the scene extension. The latter is done with a long press of the button. A short press of the button calls up the scene.

The function only recognizes the Standard sub-function. All other parameterizations for the rocker assignment are therefore ignored and Standard is used.

Note 1

If a scene is only to be recalled - i.e. a long button operation does not lead to saving - the value transmitter 1 byte (0..255) with scene numbers 0..63 can be used instead of the scene extension by permanently assigning the values. The scene numbers are displayed in the ETS from 1 to 64.

Note 2

The key repeat function is not active.

Jump

The jump function can be used to select any page using the rockers. The function only recognizes the Standard sub-function. All other parameterizations for the rocker assignment are therefore ignored and Standard is used.

Note













The key repeat function is not active.

2-channel operation







2-channel operation allows the simultaneous triggering of 2 telegrams to output values on the bus. It combines switching and value transmitter with fixed value specification in one function. The function only recognizes the Standard sub-function. All other parameterizations in the rocker assignment are therefore ignored and standard is used.

Note

























































The key repeat function is not active.

Ventilation 0%	186		Ventilation 20%	187		Ventilation 40%	188		Ventilation 60%	189		Ventilation 80%	190		Ventilation 100%	191	
Moon	261																
Oven	181																
Pump	287																
Snowflake	192																
Solar thermal	388																
Heat pump	184																
Heat exchanger	183																







Time

































Date	96	
Calendar	336	
Stopwatch	97	
Timer	389	
Clock	65	
Alarm clock	13	

Window

Window tilted	438		Window closed	437		Window open	505		Double casement window closed	439		Window double-leaf open	440				
Garage 0%	153		Garage 20%	152		Garage 40%	151		Garage 60%	150		Garage 80%	149		Garage 100%	148	
Garage roller shutter 0%	159		Garage roller shutter 20%	158		Garage roller shutter 40%	157		Garage roller shutter 60%	156		Garage roller shutter 80%	155		Garage roller shutter 100%	154	
Slats 0%	344		Slats 20%	345		Slats 40%	346		Slats 60%	347		Slats 80%	348		Slats 100%	349	
Slat curtain 0%	90		Slat curtain 20%	91		Slat curtain 40%	92		Slat curtain 60%	93		Slat curtain 80%	94		Slat curtain 100%	95	
Awning 0%	23		Awning 20%	24		Awning 40%	25		Awning 60%	26		Awning 80%	27		Awning 100%	28	
Venetian blind 0%	40		Venetian blind 20%	41		Venetian blind 40%	42		Venetian blind 60%	43		Venetian blind 80%	44		Venetian blind 100%	45	
Roller shutter 0%	328		Roller shutter 20%	329		Roller shutter 40%	330		Roller shutter 60%	331		Roller shutter 80%	332		Roller shutter 100%	333	
Door 1 tilted	464		Door 1 closed	106		Door 2 tilted	465		Door 2 closed	107		Door 2 open	108				
Angle 1	14		Angle 2	15		Angle 3	16		Angle 4	17							

Other

Refresh	294										
At symbol	243	@									
Exclamation mark	476	!									
Beamer	38										
Irrigation 0%	419		Irrigation 33%	420		Irrigation 66%	421		Irrigation 100%	422	

Movement 1	257		Movement 2	258		Movement 3	259		Motion off	526				
Envelope	112		Envelope filled	113										
Diagram	61													
Document 1	116		Document 2	117		Email in	114		Email out	115				
Settings	337													
Energy management	118													
Enertex logo	119													
TV	391													
Fire on	478		Fire off	477										
Question mark	18													
Woman	447													
Hearth	385													
Dog	463		Dog prohibited	462										
Info	193													
Camera off	47		Camera off	48										
Cat	276		Cat prohibited	275										
Refrigerator	147													
Speaker 0%	357		Speaker 33%	358		Speaker 66%	359		Speaker 100%	360		Speaker off	361	







Speaker level 0%	362		Speaker level 20%	363		Speaker level 40%	364		Speaker level 60%	365		Speaker level 80%	366		Speaker level 100%	367	
Man	244																
Media	245																
MeTa Premium	484		MeTa Premium off	483		MeTa Premium display off	485		MeTa Premium rocker off	486							
MeTa Standard	482		MeTa Standard off	481													
Microphone	247		Microphone off	248													
Monitor	256																
Garbage can	412		Blue garbage can	415		Brown bin	417		Yellow bin	416		Green bin	414		Red bin	413	
Person	274																
Radio	290																
Receiver	292																
Reset	295																
Dishwasher	105																
Stop sign 1	382		Stop sign 2	383		Stop sign 3	384										
Phone receiver 1	277		Phone receiver 2	278													
Warning 1	406		Warning 2	407		Warning yellow	409		Warning green	410		Warning red	408				
Clothes dryer closed	504		Clothes dryer open	503													
Washing machine closed	524		Washing machine open	411													

Pause	267					
Arrow left	225	<				
Arrow left small	351	◀				
Arrow up	392	^				
Arrow right	327	>				
Arrow right small	352	▶				
Arrow down	109	∨				
Plus	281	+				
Plus small	356	+				
Reverse	296	◀◀				
Sauna heater off	492	🔌	<table border="1"> <tr> <td>Sauna heater on</td> <td>493</td> <td>🔌</td> </tr> </table>	Sauna heater on	493	🔌
Sauna heater on	493	🔌				
Switch	386	🔌				
Switch off	380	🔌	<table border="1"> <tr> <td>Switch on</td> <td>381</td> <td>🔌</td> </tr> </table>	Switch on	381	🔌
Switch on	381	🔌				
Key	194	🔑				
Lock active	233	🔒	<table border="1"> <tr> <td>Lock deactivated</td> <td>234</td> <td>🔒</td> </tr> </table>	Lock deactivated	234	🔒
Lock deactivated	234	🔒				
Start	279	▶				
Socket	280	🔌				
Stop	170	■				











Prohibition sign 1	457		Prohibition sign 2	458		Prohibition sign 3	459		Prohibition sign 4	460		Prohibition sign 5	461	
Forward	146													
Maintenance	480													
Next	260													
Zoom -	241													
Zoom +	242													
Back	286													

Room

Dressing room	110	
Bathroom	31	
Balcony	450	
Office	262	
Dining room	104	
Basement	29	
Children's room	195	
Kitchen	196	
Pool	282	

Sauna	334	
Sleeping	350	
Terrace	502	
Toilet	390	
Conservatory	525	
Living room	232	

Scenes

Bathing	30	
Beer	39	
Shower off	494	
Meal	472	
Watching TV	418	
Gaming	479	
Cooking off	455	
Cleaning	64	
Scene	335	
Vacation	185	

Shower on	495	
-----------	-----	---

Cooking on	456	
------------	-----	---

Cleaning prohibited	527	
---------------------	-----	---



























































Measure

Auto load	120																
Car battery 0%	49		Car battery 20%	50		Car battery 40%	51		Car battery 60%	52		Car battery 80%	53		Car battery 100%	54	
Barometer	451																
Battery storage 0%	32		Battery storage 20%	33		Battery storage 40%	34		Battery storage 60%	35		Battery storage 80%	36		Battery storage 100%	37	
Flow meter	145																
Brightness 0%	235		Brightness 20%	236		Brightness 40%	237		Brightness 60%	238		Brightness 80%	239		Brightness 100%	240	
Compass	436																
Air humidity	291																
Moon phase waxing crescent moon	490		Moon phase waxing crescent moon	491		Moon phase new moon	528		Moon phase full moon	487		Moon phase waxing moon	489		Moon phase waxing crescent moon	488	
Solar 1	288		Solar 2	289													
Voltage 1	393		Voltage 2	394		Voltage 3	395										
Power pole 1	283		Power pole 2	284													
Temperature	387																
Heat meter	182																
Water meter	423																
Weather colored rain	433		Weather colored snow	434		Weather colored sun	430		Weather colored sun/cloud/rain	435		Weather colored sun/clouds	431		Weather colored cloud	432	
Weather rain	427		Weather snow	428		Weather sun	424		Weather sun/cloud/rain	429		Weather sun/clouds	425		Weather cloud	426	

Windsock 0%	441		Windsock 20%	442		Windsock 40%	443		Windsock 60%	444		Windsock 80%	445		Windsock 100%	446	
Counter	246																

















































Light

Alarm off	338		Alarm on	339		Alarm fire	340		Alarm gas	343		Alarm oil	341		Alarm water	342	
Outdoor light 0%	121		Outdoor light 20%	122		Outdoor light 40%	123		Outdoor light 60%	124		Outdoor light 80%	125		Outdoor light 100%	126	
Floor LED 0%	219		Bottom LED 20%	220		Floor LED 40%	221		Floor LED 60%	222		Floor LED 80%	223		Bottom LED 100%	224	
Ceiling LED 0%	213		Ceiling LED 20%	214		Ceiling LED 40%	215		Ceiling LED 60%	216		Ceiling LED 80%	217		Ceiling LED 100%	218	
Ceiling light 0%	55		Ceiling light 20%	56		Ceiling light 40%	57		Ceiling light 60%	58		Ceiling light 80%	59		Ceiling light 100%	60	
Color temperature 0%	66		Color temperature 20%	67		Color temperature 40%	68		Color temperature 60%	69		Color temperature 80%	70		Color temperature 100%	71	
Corridor wall light 0%	164		Corridor wall light 20%	165		Corridor wall light 40%	166		Corridor wall light 60%	167		Corridor wall light 80%	168		Corridor wall light 100%	169	
Light bulb 0%	226		Light bulb 20%	227		Light bulb 40%	228		Light bulb 60%	229		Light bulb 80%	230		Light bulb 100%	231	
Panel light 0%	496		Panel light 20%	497		Panel light 40%	498		Panel light 60%	499		Panel light 80%	500		Panel light 100%	501	
Pendant light 0%	268		Pendant light 20%	269		Pendant light 40%	270		Pendant light 60%	271		Pendant light 80%	272		Pendant light 100%	273	
RGB 0%	321		RGB 20%	322		RGB 40%	323		RGB 60%	324		RGB 80%	325		RGB 100%	326	
RGB blue level 0%	303		RGB blue level 20%	304		RGB blue level 40%	305		RGB blue level 60%	306		RGB blue level 80%	307		RGB blue level 100%	308	
RGB green level 0%	309		RGB green level 20%	310		RGB green level 40%	311		RGB green level 60%	312		RGB green level 80%	313		RGB green level 100%	314	
RGB red level 0%	315		RGB red level 20%	316		RGB red level 40%	317		RGB red level 60%	318		RGB red level 80%	319		RGB red level 100%	320	

RGB level 0%	297	 RGB	RGB level 100%	298	 RGB	RGB level Colored	299	 RGB										
Mirror light 0%	250		Mirror light 20%	251		Mirror light 40%	252		Mirror light 60%	253		Mirror light 80%	254		Mirror light 100%	255		
Floor lamp 0%	139		Floor lamp 20%	140		Floor lamp 40%	141		Floor lamp 60%	142		Floor lamp 80%	143		Floor lamp 100%	144		
Spotlight 0%	368		Spotlight 20%	369		Spotlight 40%	370		Spotlight 60%	371		Spotlight 80%	372		Spotlight 100%	373		
Table lamp 0%	98		Table lamp 20%	99		Table lamp 40%	100		Table lamp 60%	101		Table lamp 80%	102		Table lamp 100%	103		
Stair light 0%	374		Stair light 20%	375		Stair light 40%	376		Stair light 60%	377		Stair light 80%	378		Stair light 100%	379		
Wall light 0%	518		Wall light 20%	519		Wall light 40%	520		Wall light 60%	521		Wall light 80%	522		Wall light 100%	523		
Wall light up 0%	512		Wall light up 20%	513		Wall light up 40%	514		Wall light up 60%	515		Wall light up 80%	516		Wall light up 100%	517		
Wall light up/down 0%	506		Wall light up/down 20%	507		Wall light up/down 40%	508		Wall light up/down 60%	509		Wall light up/down 80%	510		Wall light up/down 100%	511		
Wall light down 0%	466		Wall light down 20%	467		Wall light down 40%	468		Wall light down 60%	469		Wall light down 80%	470		Wall light down 100%	471		
Christmas tree off	62		Christmas tree on	63														

Icon families



























































Refresh							
Alarm							
Alarm fire							
Alarm gas							
Alarm oil							
Alarm water							
Dressing room							
At symbol	@						
Recording	●						
Off/On							
Exclamation mark	!						
Outdoor light							
Eject							
Auto load							
Auto/Manual							
Car battery							
Automatic/Manual mode							
Bathing							
Bathroom							
Balcony							
Barometer							
Battery storage							
Beamer							
Operating mode							
Irrigation							































































Movement							
Movement 1							
Movement 2							
Beer							
Flash							
Letter							
Office							
Date							
Ceiling LED strip							
Ceiling lamp							
Diagram							
Document 1							
Document 2							
Flow meter							
Shower							
Email							
Eco							
Eco 2							
Settings							
Energy management							
Enertex logo							
Meal							
Dining room							
Color temperature							
Window							
Tilt window							

Double casement window						
Watching TV						
TV						
Fire on						
Corridor light						
Corridor wall light						
Question mark						
Woman						
Floor LED strip						
Underfloor heating						
Underfloor heating level						
Gaming						
Garage						
Garage roller shutter						
Building protection 1						
Building protection heat						
Building protection cold						
Glass door						
Tilt glass door						
Light bulb						
Radiator						
Heating rod						
Heating element levels						
Brightness levels	 Lux	 Lux	 Lux	 Lux	 Lux	 Lux
Hearth						
Dog						

Info						
Calendar						
Camera off						
Cat						
Basement						
Children's room						
Air conditioning heating						
Air conditioning cooling						
Cooking						
Compass						
Circle						
Circle small						
Kitchen						
Cooling/Heating						
Refrigerator						
Slat						
Slat angle						
Slat curtain						
Speaker						
Volume levels						
LED 3D blue						
LED 3D cyan						
LED 3D yellow						
LED 3D green						
LED 3D red						
LED 3D violet						

LED 3D white									
LED blue									
LED cyan									
LED yellow									
LED green									
LED red									
LED violet									
LED white									
Fan									
Fan cooling									
Fan manual/auto									
Fan speeds									
Air humidity									
Ventilation									
Man									
Awning									
Media									
MeTa Premium									
MeTa Premium display shutdown									
MeTa Premium rocker shutdown									
MeTa Standard									
Microphone									
Minus/Plus									
Minus/Plus small									
Moon phase									
Monitor									

Garbage can							
Garbage can 2							
Garbage can 3							
Garbage can 4							
Waste garbage can 5							
Waste garbage can 6							
Oven							
Ok							
Ok filled							
Panel light							
Pause/Start							
Pendant light							
Person							
Arrows left/right							
Arrows left/right small							
Arrows down/up							
Pool							
Power							
Pump							
Radio							
Venetian blind							
Receiver							
Reset							
RGB							
RGB blue levels							
RGB colored							

RGB green levels	 G	 G	 G	 G	 G	 G
RGB red levels	 R	 R	 R	 R	 R	 R
RGB slider						
Roller shutter						
Reverse/Forward						
Sauna						
Sauna heater						
Switch						
Bedroom						
Key						
Snowflake						
Solar 1						
Solar 2						
Solar thermal						
Voltage						
Lock						
Mirror light						
Dishwasher						
Socket						
Stop/Start						
Stop sign 1						
Stop sign 2						
Stop sign 3						
Stopwatch						
Spotlight						
Power grid						

Mute							
Scene							
Phone							
Temperature							
Terrace							
Timer							
Table light							
Toilet							
Stair light							
Door							
Tilt door							
Clock							
Vacation							
Prohibition 1							
Prohibition 2							
Prohibition 3							
Prohibition 4							
Prohibition 5							
Wall heating levels							
Wall light							
Wall light up							
Wall light up/down							
Wall light down							
Heat pump							
Heat exchanger							
Heat meter							

Warning							
Warning 2							
Warning 3							
Warning 4							
Warning 5							
Maintenance							
Clothes dryer							
Washing machine							
Water meter							
Alarm clock							
Christmas tree							
Weather							
Weather colored							
Windsock							
Angle adjustment							
Conservatory							
Living room							
Counter							
Gears							
Room service							
Zoom							
Back/Next							

ETS application

Specification

ETS: from version 5.7.4

Database file

At <https://www.enertex.de/e-downloads.html> you will find the current ETS database file and the current product description.

Parameters

The parameter description is integrated into the context help of the ETS if it is not self-explanatory.

Communication objects

Note: Depending on the parameterization, some objects may not be available.

ID	Name	Object function	Description and release	Length	DPT
1	General - Output	Request date / time	1 bit object for requesting time synchronization. This object can optionally be used to control the request object of a KNX system clock. If the existing KNX clock supports this function, it sends a time telegram back to the device in response to the request, which ensures that a valid time is set immediately after a device reset.	1 bit	DPST-1-17
2	General - Input	Date	3 byte object for setting the date of the device's internal system clock. The system clock controls the display of the date in the device display and the timer. The real-time clock has a calendar function. Depending on the date set, the day of the week required for processing the timer is automatically determined using the internal calendar. The system clock sets the last default via the bus.	3 bytes	DPST-11-1
3	General - Input	Time	3 byte object for setting the time of the device's internal system clock. The system clock controls the display of the time on the device display and the timer. The real-time clock has a calendar function. Depending on the set date (see object 2), the day of the week required for processing the time switch is automatically determined using the internal calendar. The day of the week transmitted in the KNX time telegram in accordance with DPT 10.001 is irrelevant and is discarded by the device. The system clock is set by the last specification via the bus.	3 bytes	DPST-10-1
4	General - Input	Date / Time	6 byte object for setting the date and time of the device's internal system clock. The system clock controls the display of the date in the device display and the timer. The real-time clock has a calendar function. Depending on the date set, the day of the week required for processing the timer is automatically determined using the internal calendar. The system clock sets the last default via the bus.	8 bytes	DPST-19-1
6	General - Input	Display brightness	Set the brightness of the premium display. This is only enabled if automatic control is deactivated.	1 byte	DPST-5-1
7	General - Input	Rocker brightness	Set the brightness of the rocker displays. This is only enabled if automatic control is deactivated.	1 byte	DPST-5-1
8	General - Input	Display switch-off	Switch premium display completely off or on	1 bit	DPST-1-2
9	General - Input	Rocker switch-off	Switch rocker display completely off or on	1 bit	DPST-1-2
10	General - Input	User icon	Display of an icon (U) in the premium display, ID see p. 44	2 byte	DPST-7-1

ID	Name	Object function	Description and release	Length	DPT
11	General - Input	Weather	8 bit object with the following assignment (Premium display only) No weather symbol (0), Sun (1) Rain (2), Snow (3), Clouds (4) , Sun & clouds (5), Sun & Clouds & Rain (6) Clouds & Rain (7)	1 byte	DPT-5
12	General - Input	Outdoor temperature	CO for the information display of the outside temperature, temperature in °C	2 bytes	DPST-9-1
13	Weather info - Input	Lowest temperature	CO for the weather display in the premium display, temperature in °C	2 bytes	DPST-9-1
14	Weather info - Input	Maximum temperature	CO for the weather display in the premium display, temperature in °C	2 bytes	DPST-9-1
15	Weather info - Input	Amount of precipitation	CO for the weather display in the premium display, precipitation amount in l/m ²	2 bytes	DPST-9-26
17	Input 1 (input) - output	Value	If input 1 on the back of the device is parameterized as a push-button, the CO is 1 bit and shows the status of the switch. If the input is for evaluating the remote sensor, the CO is a 16 bit floating point value that represents the currently measured temperature.	1 bit/ 2 bytes	DPST-9-1
18	Input 2 (input) - output	Value	If input 2 on the back of the device is parameterized as a push-button, the CO is 1 bit and shows the status of the switch. If the input is for evaluating the remote sensor, the CO is a 16 bit floating point value that represents the currently measured temperature.	1 bit/ 2 bytes	DPST-9-1
19	Motion detector - Output	Presence	1 bit object to indicate motion detection in the middle zone. The object is reset after a parameterizable time.	1 bit	DPST-1-2
20	Motion detector - Output	Presence close range	1 bit object for indicating motion detection in the near zone. The object is reset after a parameterizable time.	1 bit	DPST-1-2
21	Motion detector - Output	Presence remote area	1 bit object for indicating motion detection in the remote zone. The object is reset after a parameterizable time.	1 bit	DPST-1-2
22	Motion detector - Input	Locking object	Blocking object for motion detection of the middle zone	1 bit	DPST-1-1
23	Motion detector - Input	Blocking object close range	Blocking object for motion detection of the near zone	1 bit	DPST-1-1
24	Motion detector - Input	Remote blocking object	Blocking object for motion detection of the remote zone	1 bit	DPST-1-1
25	Dew point output	Dew point	16 bit floating point object with the output of the current dew point.	2 bytes	DPST-9-1

27	Temperature output	Actual temperature	16 bit floating point object with the output of the determined mixed temperature from all temperatures according to the specification in the Measured values tab. This temperature also represents the temperature that is used as an input variable for the controller.	2 bytes	DPST-9-1
28	Temperature output	Internal temperature	16 bit floating point object with the output of the current internally measured temperature.	2 bytes	DPST-9-1
31	Temperature input	External temperature	16 bit floating point object, which represents a temperature of another KNX measuring point.	2 bytes	DPST-9-1
32	Humidity - Output	Internal humidity	16 bit floating point object with the output of the current internally measured relative humidity.	2 bytes	DPST-9-7
33	Brightness - Output	Internal brightness	16 bit floating point object with the output of the current internally measured light intensity in lux.	2 bytes	DPST-9-4
34	Page switching 1 - Input	Change page	1 bit object for triggering the switchover to a page that has been configured parameter-dependently	1 bit	DPST-1-2

ID	Name	Object function	Description and release	Length	DPT
35	Page switching 2 - Input	Change page	1 bit object for triggering the switchover to a page that has been configured parameter-dependently	1 bit	DPST-1-2
36	Page switching - Input	Change page	8 bit object for triggering the switchover to a specific page, which is also transferred in the CO. Valid values from 1 to 10	1 byte	DPT-5
38	Channel 1 - Output	Switching	1 bit object for controlling a switching channel if the channel is parameterized for switching	1 bit	DPST-1-1
		Switching	1 bit object for controlling a dimmer via an On/Off object if the channel is parameterized to dimming	1 bit	DPST-1-1
		Switching	1 bit object for controlling a dimmer for Tuneable White (TW) via an On/Off object if the channel is parameterized to Dimming TW	1 bit	DPST-1-1
		Switching	1 bit object to control a dimmer for coloured light control (RGB) via an on/off object if the channel is parameterized to dimming	1 bit	DPST-1-1
		Short-term operation	1 bit object to control a shutter/awning actuator for short-time operation	1 bit	DPST-1-7
		Short-term operation	1 bit object to control a blind actuator for short-time operation	1 bit	DPST-1-7
		Scene extension	8 bit object to control a scene extension unit	1 byte	DPST-18-1
		Switching	1 bit object for controlling a switching channel if the channel is parameterized for two-channel operation	1 bit	DPST-1-1
39	Channel 1 - Output	Switching feedback	1 bit feedback object of a switching channel if the channel is parameterized to switching	1 bit	DPST-1-1
		Switching feedback	1 bit feedback object (On/Off) of a dimmer channel if the channel is parameterized to dimming	1 bit	DPST-1-1
		Switching feedback	1 bit feedback object (On/Off) of a dimmer channel if the channel is parameterized to dimming TW	1 bit	DPST-1-1
		Switching feedback	1 bit feedback object (On/Off) of a dimmer channel if the channel is parameterized to dimming RGB	1 bit	DPST-1-1
		Switching feedback	1 bit feedback object of a switching channel if the channel is parameterized for two-channel operation	1 bit	DPST-1-1
40	Channel 1 - Output	Relative dimming	4 bit object for relative dimming to control the brightness of a dimmer channel	4 bit	DPST-3-7
		Brightness value	1 byte object for brightness control (absolute) for Tuneable White Dimmer	1 byte	DPST-5-1
		Valuator	Object adapts to the data type of the parameterization. Output of a value.	1 byte	DPST-5-1, DPST-5-3, DPST-5-10, DPST-6-10
41	Channel 1 - Output	Brightness value feedback	1 byte feedback object of the brightness value (absolute) of a dimmer	1 byte	DPST-5-1
		Brightness value feedback	1 byte feedback object of the brightness value (absolute) of a tuneable white dimmer	1 byte	DPST-5-1
		Feedback Valuator	Object adapts to the data type of the parameterization. Feedback from a value transmitter for display on the rocker displays	1 byte	DPST-5-1, DPST-5-3, DPST-5-10, DPST-6-10
		Feedback hanging height	1 byte feedback object for the blind/shutter height of a shutter/awning actuator	1 byte	DPST-5-1
		Feedback hanging height	1 byte feedback object of the blind actuator's blind height	1 byte	DPST-5-1
42	Channel 1 - Output	Color temperature	Specification of the color temperature via 1 byte object with value = 0 for only warm white and value = 255 (100%) for only cold white or scaled values in between or absolute value in Kelvin as 2 byte value	1 byte resp. 2 byte	DPST-5-1 or DPST-7-6
		Dimming value RGB	3 byte RGB object for controlling an RGB dimmer channel	3 byte	DPST-232-600
		Long-term operation	1 bit object for controlling a shutter/awning actuator for long-term operation	1 bit	DPST-1-8
		Long-term operation	1 bit object to control a blind actuator for long-term operation	1 bit	DPST-1-8

ID	Name	Object function	Description and release	Length	DPT
		Valuator	Object adapts to the data type of the parameterization. Output of a value.	2 bytes or 4 byte	DPST-7-1, DPST-8-1, DPT-9, DPST-12, DPST-13, DPST-14
43	Channel 1 - Output	Color temperature feedback	Color temperature feedback via 1 byte object with value = 0 for warm white only and value = 255 (100%) for cold white only or scaled values in between or absolute value in Kelvin as 2 byte value	1 byte resp. 2 byte	DPST-5-1 or DPST-7-6
		Feedback dimming value RGB	3 byte RGB object for feedback of an RGB dimmer channel	3 byte	DPST-232-600
		Slat position feedback	1 byte feedback object for the slat position of a blind actuator	1 byte	DPST-5-1
		Valuator	Object adapts to the data type of the parameterization. Output of a value.	2 bytes or 4 byte	DPST-7-1, DPST-8-1, DPT-9, DPT-12, DPT-13, DPT-14

45-260			See CO 38-43: Objects for Channel 2 ..32		
--------	--	--	--	--	--

265	Info display premium - Input	Line 1	First line of the dynamic labelling of the 3-line info display of the Premium Display	4 byte	DPST-16-0
266	Info display premium - Input	Line 2	Second line of the dynamic labelling of the 3-line info display of the Premium Display	4 byte	DPST-16-0
267	Info display premium - Input	Line 3	Third line of the dynamic labelling of the 3-line info display of the Premium Display	4 Byte	DPST-16-0
268	Info display premium - Input	Icon	2 byte object for selecting the icon of the 3-line info display of the Premium Display	2 byte	DPST-7-1
269	Info display premium - Input	Display	1 bit object to show or hide the 3-line info display of the Premium Display	1 bit	DPST-1-1
271	Info 1 - Input	Display 1	Depending on parameterization Data point type as set in ETS.	1 bit ...14 bytes	
272 - 276	Info 1 - Input	Display 2..5	see above.	1 bit ...14 bytes	
277 - 290	Info 1 - Input - Info 4 - Input		Info displays 2 to 4 in the same way as Info 1		

295	Alarm 1 - Input	Alarm	1 bit CO as trigger for the alarm message. When the bus message arrives, a time stamp is generated and displayed in the MeTa ² . The parameterization allows a selection of different triggers for - Level-controlled - edge-controlled - event-driven.	1 bit	DPST-1-5
296 - 300	Alarm 2 - Input - Alarm 6 - Input	Alarm	See CO Alarm 1 - Input	1 bit	DPST-1-5

ID	Name	Object function	Description and release	Length	DPT
301	Event message 1 - Input	Event 1	1 bit CO as trigger for the event message. A time stamp is generated in the MeTa ² when the bus message arrives. The parameterization allows a selection of different triggers for - Level-controlled - edge-controlled - event-driven.	1 bit	DPST-1-17
302 302 310	Event message 1 - Input	Event 2..10	See description Event 1	1 bit	DPST-1-17

303 11 303 320	Event message 2 - input	Event 1..10	see above.	1 bit	DPST-1-17
304 21 304 330	Event message 3 - input	Event 1..10	see above.	1 bit	DPST-1-17
305 31 305 340	Event message 4 - input	Event 1..10	see above.	1 bit	DPST-1-17

341	Solar info - Input	Power e-charging station	Power consumption or output of a charging station in W. The polarity (sign for consumption or counting direction) is specified via the parameters. Data type depending on parameter 2 byte or 4 byte floating point.	2 / 4 bytes	DPST-9-24, DPST-14-56
342	Solar info - Input	Battery storage power	Power consumption or output of a battie memory in W. The polarity (sign for consumption or counting direction) is specified via the parameters.	4 bytes	DPST-9-24, DPST-14-56
343	Solar info - Input	PV power	Power output of a PV system in W. The polarity (sign for consumption or counting direction) is specified via the parameters.	4 bytes	DPST-9-24, DPST-14-56
344	Solar info - Input	Power energy supplier	Power consumption or output at the transfer point to the energy supply company in W. The polarity (sign for consumption or counting direction) is specified via the parameters.	4 bytes	DPST-9-24, DPST-14-56
345	Solar info - Input	State of charge of battery storage	State of charge of the battery in percent.	4 bytes	DPST-5-4, DPT-14

346	Label 1 - Input	Label text	If the CO of the label display are linked, the labeling of the correspondingly linked rocker can be updated via the KNX bus. If the labelling is parameterized with two lines, the first line is updated via this CO. If the label is parameterized to Standard or Large and the CO <i>Label text</i> and <i>Label text line 2</i> are linked, the two COs are shown next to each other in the display. The characters are displayed according to UTF-8 coding. In this way, both longer character strings and all characters of the font family available in the device can be displayed. All Western European and Eastern European fonts as well as Cyrillic, Greek, Hebrew and Arabic are available as font families. These usually require 2 bytes per character. To send these via KNX, we recommend a powerful logic engine such as the Enerterx EibPC ² , which can send the data in the appropriate encoding.	14 bytes	DPST-16-0
347	Label 1 - Input	Label text line 2	Second line of the dynamic label or the addition for single-line label.	14 bytes	DPST-16-0
348 - 361	Label 2..8 - Input	Label text Label text line 2	see above.		

362	Cleaning mode - Input	Cleaning mode	1 bit CO for activating (1) and deactivating (0) the cleaning mode. Deactivation can also be parameterized via a fallback time.	1 bit	DPST-1-1
-----	-----------------------	---------------	---	-------	----------

ID	Name	Object function	Description and release	Length	DPT
363	Signal tone - input	Signal tone 1	1 bit CO for triggering a constant tone with two interruptions per second, similar to a busy signal on a landline telephone - Beep 3: Chirp sound in the style of an 80s jump & run game. Description	1 bit	DPST-1-17
364	Signal tone - input	Signal tone 2	1 bit CO for triggering changing pitches with two smooth transitions from high to low and low twice per second	1 bit	DPST-1-17
365	Signal tone - input	Signal tone 3	1 bit CO for triggering a chirp sound in the style of an 80s jump & run game.	1 bit	DPST-1-17
366	Threshold alarm - output	Humidity alarm	1 bit CO is triggered if the parameterized threshold value is exceeded.	1 bit	DPST-1-5
367	Threshold alarm - output	Brightness alarm	1 bit CO is triggered if the parameterized threshold value is exceeded.	1 bit	DPST-1-5
368	Threshold alarm - output	Dew point alarm	1 bit CO is triggered if the parameterized threshold value is exceeded.	1 bit	DPST-1-5

372	RTC - Output	Common control variable for heating and cooling	The control value is output in a common object. No distinction is made here as to whether the control value is only for heating or only for cooling. The output is therefore equal to the maximum of the two control variables heating and cooling	1 byte	DPST-5-1
373	RTC - Input	Base setpoint	Object for external specification of the basic setpoint. Depending on the operating mode, the possible value range is limited by the parameterized "Setpoint temperature frost protection" and "Setpoint temperature heat protection". Values outside the value range are limited to the next possible value. The temperature value must always be specified in "°C" format.	2 bytes	DPST-9-1
374	RTC - Input	Operating mode switchover	Object for switching the operating mode of the controller in accordance with the KNX specification. A received value influences the operating mode icon on the device.	1 byte	DPST-20-102
375	RTC - Input	Forced object operating mode	Object for forced switchover (highest priority) of the operating mode of the controller in accordance with the KNX specification. A received value influences the operating mode icon on the device.	1 byte	DPST-20-102
376	RTC - Input	Preset setpoint shift	Object for specifying a basic setpoint shift in Kelvin, e.g. by a controller extension. The value "0" means that no shift is active. Values between -670760 K and 670760 K can be specified. If the limits of the value range are exceeded by the external value specification, the controller automatically resets the received value to the minimum or maximum limit. This object is only available if the "Type of setpoint shift" parameter is set to "Via offset (DPT 9.002)". When a value is received via the object, the display of the setpoint and the status of the slider on the device are adjusted.	2 bytes	DPST-9-2
377	RTC - Output	Common control value for additional heating and cooling stage	The control value is output to a shared object. There is no distinction made as to whether the control value is only for heating or only for cooling. The output, therefore, corresponds to the maximum of the two control values for heating and cooling.	1 byte	DPST-6-10
378	RTC - Input	Window status	Object for linking window contacts for automatic switchover to frost/heat protection operating mode. Polarity: Window open = "1", window closed = "0".	1 bit	DPST-1-19
380	RTC - Input	Lock controller	Object for deactivating the controller (activation of dew point mode). Polarity: Controller deactivated = "1", controller activated = "0". This object is only available if "Deactivate controller (dew point mode)" is parameterized to "Via bus".	1 bit	DPST-1-1
381	RTC - Input	Heating/Cooling changeover	Object for transferring the automatically set operating mode ("Heating" or "Cooling") of the controller if "Switchover between heating and cooling" is parameterized to "Automatic". If the parameter is set to "Via object (heating/cooling switchover)", the operating mode can be specified via the object. Object value "1" = heating; object value "0" = cooling.	1 bit	DPST-1-100

ID	Name	Object function	Description and release	Length	DPT
383	RTC - Input	Preset set temperature	Object for setting a target temperature for the active operating mode of the controller. The adjustment depends on the type of setpoint adjustment (parameter). 1. In the setpoint shift mode, the adjustment always affects the current operating mode (heating or cooling). In comfort mode, this directly changes the base setpoint; in standby or night mode, it adjusts the respective offset, depending on the heating and cooling mode. Thus, an adjustment of the set temperature via this KO is identical to adjusting the set temperature on the device. 2. In the independent setpoint mode, the setpoints can be adjusted on the device and via KO 383 without limitation. Automatic switching between heating and cooling is not possible.	2 bytes	DPST-9-1
384	RTC - Output	Current setpoint temperature	Object for outputting the current temperature setpoint. Depending on the operating mode, the possible value range is limited by the parameterized "Setpoint temperature frost protection" and "Setpoint temperature heat protection". The temperature value is always output in "°C" format.	2 bytes	DPST-9-1
385	RTC - Output	Current setpoint shift	Object for feedback of the current basic setpoint shift in Kelvin, for evaluation e.g. by a controller extension. The value "0" means that no shift is active. This object is only available if the "Type of setpoint shift" parameter is set to "Via offset (DPT 9.002)".	2 bytes	DPST-9-2
386	RTC - Output	Temperature drop detection	Object for reporting a temperature drop on the KNX. This object is only available if the "Frost/heat protection" parameter is set to "Automatic frost protection mode". The device reports a temperature drop if the temperature drops by a parameterizable value in K in a certain time in min ("Automatic frost protection temperature reduction" parameter). Object value = "1": Temperature drop detection, object value = "0": no temperature drop detection.	1 bit	DPST-1-19
387	RTC - Output	KNX status operating mode	Object via which the controller outputs the current operating mode. When the operating mode is switched by an operation on the device, a telegram with the newly selected operating mode is sent out.	1 byte	DPST-20-102
390	RTC - Output	KNX status	Object via which the KNX-harmonized controller displays elementary basic functions.	2 bytes	DPST-22-101
391	RTC - Output	KNX combined status RTSM	Object via which the controller provides KNX-harmonized bit-coded values about its input status: Window open/closed, Presence present/absent, Comfort mode active/inactive, Comfort extension active/inactive, User mode active/inactive.	1 byte	DPST-21-107
392	RTC - Output	KNX combined status RTC	Object via which the controller provides KNX-harmonized bit-coded values about its internal status: Error status active/inactive, active cooling/heating mode, dew point mode active/inactive, frost alarm active/inactive, overheating alarm active/inactive, current controller status active/inactive, additional stage active/inactive, heating mode active/inactive, cooling mode active/inactive.	2 bytes	DPST-22-103
393	RTC - Output	Heating message	Object for signaling the controller whether heating energy is requested. Object value = "1": Energy request, object value = "0": no energy request.	1 bit	DPST-1-1
394	RTC - Output	Cooling message	Object for signaling the controller whether cooling energy is requested. Object value = "1": Energy request, object value = "0": no energy request.	1 bit	DPST-1-1
395	RTC - Output	Heating actuating variable	Object for outputting the continuous control value of the heating mode. This object is only available in this way if the type of heating control is parameterized to "Continuous PI control".	1 byte	DPST-5-1
		PWM actuating variable for heating	Object for outputting the continuous control value of the heating mode. This object is only available in this way if the type of heating control is parameterized to "Switching PI control (PWM)". This means that in addition to the switching 1 bit PWM control value, the calculated continuous control value of the controller can also be sent to the bus and displayed in a visualization, for example.	1 byte	DPST-5-1
397	RTC - Output	Heating actuating variable (PWM)	Object for outputting the PWM control value for heating mode. This object is only available in this way if the type of heating control is parameterized to "Switching PI control (PWM)".	1 bit	DPST-1-1
		Heating actuating variable (2-point)	Object for outputting the 2-point control value for heating mode. This object is only available in this way if the type of heating control is parameterized to "Switching 2-point control".	1 bit	DPST-1-1
398	RTC - Output	Control variable cooling	Object for outputting the continuous control value of the cooling mode. This object is only available in this way if the type of cooling control is parameterized to "Continuous PI control".	1 byte	DPST-5-1

ID	Name	Object function	Description and release	Length	DPT
		PWM actuating variable cooling	Object for outputting the continuous control value of the cooling mode. This object is only available in this way if the type of cooling control is parameterized to "Switching PI control (PWM)". This means that in addition to the switching 1 bit control value of the PWM, the calculated continuous control value of the controller can also be sent to the bus and displayed in a visualization, for example.	1 byte	DPST-5-1
399	RTC - Output	Cooling actuating variable (PWM)	Object for outputting the PWM control variable of the cooling mode. This object is only available in this way if the type of cooling control is parameterized to "Switching PI control (PWM)".	1 bit	DPST-1-1
		Control variable cooling (2-point)	Object for outputting the 2-point control variable for cooling mode. This object is only available in this way if the type of cooling control is parameterized to "Switching 2-point control".	1 bit	DPST-1-1
400	RTC - Output	Control value heating additional stage	Object for outputting the continuous control value for the additional heating in two-stage operation. This object is only available in this way if the type of heating control is parameterized to "Continuous PI control".	1 byte	DPST-5-1
		PWM control variable heating additional stage	Object for outputting the continuous control value for the additional heating in two-stage operation. This object is only available in this way if the type of heating control is parameterized to "Switching PI control (PWM)". This means that in addition to the switching 1 bit control value of the PWM, the calculated continuous control value of the controller can also be sent to the bus and displayed in a visualization, for example.	1 byte	DPST-5-1
401	RTC - Output	Control value heating additional stage (PWM)	Object for outputting the PWM control value for the additional heating in two-stage operation. This object is only available in this way if the type of heating control is parameterized to "Switching PI control (PWM)".	1 bit	DPST-1-1
		Control value heating additional stage (2-point)	Object for outputting the 2-point control value for the additional heating in two-stage operation. This object is only available in this way if the type of heating control is parameterized to "Switching 2-point control".	1 bit	DPST-1-1
402	RTC - Output	Control value cooling additional stage	Object for outputting the continuous control value for additional cooling in two-stage operation. This object is only available in this way if the type of cooling control is parameterized to "Continuous PI control".	1 byte	DPST-5-1
		PWM actuating variable cooling additional stage	Object for outputting the continuous control value for additional cooling in two-stage operation. This object is only available in this way if the type of cooling control is parameterized to "Switching PI control (PWM)". This means that in addition to the switching 1 bit control value of the PWM, the calculated continuous control value of the controller can also be sent to the bus and displayed in a visualization, for example.	1 byte	DPST-5-1
403	RTC - Output	Control value cooling additional stage (PWM)	Object for outputting the PWM control variable for additional cooling in two-stage operation. This object is only available in this way if the type of cooling control is parameterized to "Switching PI control (PWM)".	1 bit	DPST-1-1
		Control value cooling additional stage (2-point)	Object for outputting the 2-point control value for additional cooling in two-stage operation. This object is only available in this way if the type of cooling control is parameterized to "Switching 2-point control".	1 bit	DPST-1-1
404	RTC - Input	Lock additional stage	1 bit object for deactivating the additional stage of the controller. Polarity: Additional stage deactivated = "1", additional stage activated = "0". This object is only available in this way if two-stage heating or cooling mode is parameterized.	1 bit	DPST-1-1
405	RTC - Output	Feedback Lock additional stage	Object for feedback of the Disable additional level object. Object serves as an output for feedback to a controller extension.	1 bit	DPST-1-1
406	RTC - Output	Split unit switching	The controller sends an additional switching command via this KO as soon as the control value responsible for operating the split unit drops to 0% and does not rise above 1% again.	1 bit	DPST-1-1
407	RTC - Output	Split unit ventilation, fan level 1-4	Setting the fan level from 1 to 4. By using KO 406, the fan control can be implemented with level 0 (OFF).	1 byte	DPST-5-100
408	RTC - Output	Split unit control value fan (percentage)	Output of a control value for the split unit, enabling it to determine a cooling or heating demand.	1 byte	DPST-5-1
409	RTC - Input	Ventilation, forced position	Object for activating the forced fan position. Polarity: Forced position ON = "1"; Forced position OFF = "0".	1 bit	DPST-1-1
410	RTC - Input	Ventilation, level limitation	Object for activating the fan level limitation. Polarity: Fan level limitation ON = "1"; Fan level limitation OFF = "0".	1 bit	DPST-1-1

ID	Name	Object function	Description and release	Length	DPT
411	RTC - Input	Ventilation, fan protection	Object for activating fan protection. Polarity: Fan protection ON = "1"; Fan protection OFF = "0".	1 bit	DPST-1-1
412	RTC - Input	Preset ventilation auto/manual	Object for setting the fan operating mode ("1" = auto; "0" = manual). This object serves as an input for control by a controller substation with fan control. When a value is received through the object, the display of the value on the device is adjusted.	1 bit	DPST-1-1
413	RTC - Input	Preset fan level	Object for setting the fan level. This object serves as an input for control by a controller substation with fan control. The setpoint is only considered if the ventilation is in manual mode. Value meaning: "0" = Fan OFF, "1" = Level 1 active, "2" = Level 2 active, and "3" = Level 3 active. This object is only available in this way if the fan control is to be done via 1 byte (parameter-dependent). When a value is received through the object, the display of the value and the status of the fan symbol on the device are adjusted.	1 byte	DPST-5-100
414	RTC - Input	Preset fan level (percentage)	Object for setting the fan speed in percent. This object serves as an input for control by a controller substation with fan control. The setpoint is only considered if the ventilation is in manual mode. The received percentage values are mapped to 3 fan levels, with the mapping being fixed and not configurable. According to the received percentage values, the following fan levels are displayed on the device: "0%" = "Fan OFF", "1 .. 33%" = "Fan Level 1", "34 .. 66%" = "Fan Level 2", and "67 .. 100%" = "Fan Level 3".	1 byte	DPST-5-1
415	RTC - Output	Ventilation, fan speed 1-3	Object for value-based control of the fan speed. This object is only available in this way if the fan is to be controlled via 1 byte (parameter-dependent). Value meaning: "0" = fan OFF, "1" = level 1 active, "2" = level 2 active and "3" = level 3 active. This object is only available in this way if the fan is to be controlled via 1 byte (parameter-dependent).	1 byte	DPST-5-100
		Ventilation, fan speed 1	Object for switching control of the first fan speed. This object is only available in this way if the fan is to be controlled via 3 x 1 bit and at least one fan speed is enabled (parameter-dependent).	1 byte	DPST-1-1
416	RTC - Output	Ventilation, fan speed 2	Object for switching control of the second fan speed. This object is only available in this way if the fan is to be controlled via 3 x 1 bit and at least two fan levels are enabled (parameter-dependent).	1 bit	DPST-1-1
417	RTC - Output	Ventilation, fan speed 3	Object for switching control of the first fan speed. This object is only available in this way if the fan is to be controlled via 3 x 1 bit and at least three fan levels are enabled (parameter-dependent).	1 bit	DPST-1-1
418	RTC - Output	Feedback ventilation auto/manual	Object for feedback of the current fan operating mode (polarity can be parameterized). Object is used as an output for feedback to a controller extension with fan control. When the operating mode is switched by an operation on the device, a telegram corresponding to the current status is sent to the bus.	1 bit	DPST-1-1
419	RTC - Output	Fan level feedback	Object for additional value-guided feedback of the active fan speed. Object is used as an output for feedback to a controller extension with fan control. Value meaning: "0" = fan OFF, "1" = level 1 active, "2" = level 2 active and "3" = level 3 active. When touching the slider on the fan control side of the device, this object is sent to the bus with the newly selected value with a delay of 2s. When touching the plus or minus symbol, this object is sent to the bus with the newly selected value with a delay of 2s.	1 byte	DPST-5-100
420	RTC - Output	Fan level feedback (percent)	Object for additional value-controlled feedback of the active fan speed as a percentage. Object serves as an output for feedback to a controller extension with fan control. This object can be enabled via the parameter "Additional object for specification and feedback of fan speed in percent". The percentage values to be sent are fixed and cannot be parameterized. following percentage values are sent according to the selected fan level: "Fan OFF"="0%", "Fan level 1"="33%", "Fan level 2"="66%" and "Fan level 3"="100%"	1 byte	DPST-5-1
421	RTC - Output	Fan control value (percent)	Object for value-based control of fan speed in percent. This object can be enabled via the "Additional object for fan control value in percent" parameter. The percentage value to be sent is calculated from the currently selected fan speed, whereby the values of the parameters "Fan control value (percentage) for fan speed 1", "Fan control value (percentage) for fan speed 2" and "Fan control value (percentage) for fan speed 3" determine the mapping.	1 byte	DPST-5-1

ID	Name	Object function	Description and release	Length	DPT
426	CE 1 - Input	Actual temperature	Object for recording the actual temperature. The value received is only used for display purposes. The temperature value must always be specified in "°C" format. When a value is received via the object, the display of the actual value on the device is adjusted.	2 bytes	DPST-9-1
427	CE 1 - Input	Set temperature	Object for receiving the current temperature setpoint. The device receives the temperature value in "°C" format. When a value is received via the object, the display of the setpoint and the status of the slider on the device are adjusted.	2 bytes	DPST-9-1
428	CE 1 - Input	Currently active operating mode	Object via which the controller extension can receive the current operating mode. A received value influences the operating mode icon on the device.	1 byte	DPST-20-102
429	CE 1 - Input	Current setpoint shift	Object for feedback of the current base setpoint shift in Kelvin. The value "0" means that no shift is active. This object is only available if the "Type of setpoint shift" parameter is set to "Via offset (DPT 9.002)". This influences the slider on the controller extension side, provided that the fade-in of the slider is parameterized.	2 bytes	DPST-9-2
		Current setpoint shift	Object via which the extension receives the current basic setpoint shift of the room temperature controller. This object is only available if the "Type of setpoint shift" parameter is set to "Via stages (DPT 6.010)". This influences the slider on the controller extension side, provided that the display of the slider is parameterized.	1 byte	DPST-6-10
430	CE 1 - Input	KNX status	Object via which the KNX-harmonized controller displays elementary basic functions.	2 bytes	DPST-22-101
431	CE 1 - Input	Feedback ventilation auto/manual	Object for feedback of the current fan operating mode ("1" = auto; "0" = manual).	1 bit	DPST-1-1
432	CE 1 - Input	Fan level feedback	Object for additional value-guided feedback of the active fan level. Value meaning: "0" = fan OFF, "1" = level 1 active, "2" = level 2 active, "3" = level 3 active.	1 byte	DPST-5-100
433	CE 1 - Input	Fan level feedback (percent)	Object for additional value-guided feedback of the active fan level. This object is used as an input for displaying a fan level that is sent by a room temperature controller (main controller) with fan control. The percentage values received are mapped to 3 fan levels, whereby the mapping is fixed and cannot be parameterized. The following fan levels are displayed on the device according to the percentage values received: "0%"="Fan OFF", "1 ... 33%"="Fan level 1", "34 ... 66%"="Fan level 2" and "67 ... 100%"="Fan level 3".	1 byte	DPST-5-1
434	CE 1 - Output	Operating mode switchover	Object with which a room temperature controller (main controller) can be switched between the Comfort, Standby, Night and Frost/heat protection operating modes. When the operating mode icon is touched, this object is sent to the bus with the newly selected operating mode with a delay of 2 seconds.	1 byte	DPST-20-102
435	CE 1 - Output	Specification of setpoint shift	Object for specifying a basic setpoint shift in Kelvin. The object is used as an output for controlling a room temperature controller (main controller). The value "0" means that no shift is active. Values between -670760 K and 670760 K can be specified. This object is only available if the "Type of setpoint shift" parameter is set to "Via offset (DPT 9.002)".	2 bytes	DPST-9-2
		Specification of setpoint shift	Object for specifying a basic setpoint shift for a controller. This object is used as an output for controlling a room temperature controller (main controller). As the device only allows four levels, only the following values are permitted: -4, -3, -2, -1, 0, 1, 2, 3, 4. This object is only available if the "Type of setpoint shift" parameter is set to "Via levels (DPT 6.010)".	1 byte	DPST-6-10
437	CE 1 - Output	Preset ventilation auto/manual	Object for specifying the fan operating mode ("1" = auto; "0" = manual). Object serves as an output for controlling a room temperature controller (main controller) with fan control. When touching the word "Man." or "Auto" on the device, this object is sent to the bus with the corresponding value.	1 bit	DPST-1-1
438	CE 1 - Output	Preset fan level	Object for specifying the fan speed. Object is used as an output for controlling a room temperature controller (main controller) with fan control. Value meaning: "0" = fan OFF, "1" = level 1 active, "2" = level 2 active and "3" = level 3 active.	1 byte	DPST-5-100

ID	Name	Object function	Description and release	Length	DPT
439	CE 1 - Output	Feedback fan level (percentage)	Object for specifying the fan speed as a percentage. This object is used as an output for controlling a room temperature controller (main controller) with fan control. This object can be enabled via the parameter "Additional object for fan speed specification and feedback in percent". The percentage values to be sent are fixed and cannot be parameterized. following percentage values are sent according to the selected fan level: "Fan OFF"="0%", "Fan level 1"="33%", "Fan level 2"="66%" and "Fan level 3"="100%"	1 byte	DPST-5-1
440	CE 1 - Input	Feedback control value heating	Object for feedback of the current control value. This object is used as an input for displaying the current control value in heating mode, which is sent by a room temperature controller (main controller). The received percentage values are mapped to 5 symbols, whereby the mapping is fixed and cannot be parameterized. The following symbols are displayed according to the percentage values received: "0%"="Heating OFF" (no bar), "1 ... 40%"="Heating symbol 1" (1 bar), "41 ... 60%"="Heating symbol 2" (2 bars), "61 ... 80%"="Heating symbol 3" (3 bars), "81 ... 100%"="Heating symbol 4" (4 bars).	1 byte	DPST-5-1
441	CE 1 - Input	Feedback control value cooling	Object for feedback of the current control value. This object is used as an input for displaying the current control value in cooling mode, which is sent by a room temperature controller (main controller). The received percentage values are mapped to 5 symbols, whereby the mapping is fixed and cannot be parameterized. The following symbols are displayed according to the percentage values received: "0%"="Cooling OFF" (no bar), "1 ... 40%"="Cooling symbol 1" (1 bar), "41 ... 60%"="Cooling symbol 2" (2 bars), "61 ... 80%"="Cooling symbol 3" (3 bars), "81 ... 100%"="Cooling symbol 4" (4 bars).	1 byte	DPST-5-1
442	CE 1 - Output	Switching	1 bit object for turning the controller on and off	1 bit	DPST-1-1
443	CE 1 - Input	Feedback switching	Feedback object for displaying the on and off status of the controller	1 bit	DPST-1-1
444 - 497			See CO 426-443: Objects for CE 2-4		
498	SU 1 - Output	Switching	1 bit object for switching a split unit on and off	1 bit	DPST-1-1
499	SU 1 - Input	Switching feedback	Feedback object for displaying the On and Off status of a split unit	1 bit	DPST-1-1
500	SU 1 - Output	Operating mode switchover	Operating mode of a split unit. The following operating modes can be selected in the MeTa:: Automatic mode DPT20_105_AUTO (0) Heating DPT20_105_HEAT (1) Cooling DPT20_105_COOL (3) Ventilation DPT20_105_FAN_ONLY (9) Dry DPT20_105_DEHUMIDIFICATION (14)	1 byte	DPST-20-105
501	SU 1 - Input	Feedback operating mode switchover	Feedback on operating mode (see CO 500)	1 byte	DPST-20-105
502	SU 1 - Output	Set temperature	Specification of a setpoint temperature for the split unit	2 bytes	DPST-9-1
503	SU 1 - Input	Set temperature feedback	Feedback object for the setpoint temperature of the split unit	2 bytes	DPST-9-1
504	SU 1 - Input	Actual temperature	Current actual temperature measured by the split unit.	2 bytes	DPST-9-1
505	SU 1 - Output	Default ventilation auto/manual	Default object for manual control of the fan stages of a split unit	1 bit	DPST-1-1
506	SU 1 - Input	Feedback ventilation auto/manual	Feedback object for manual or automatic control of the fan stages of a split unit	1 bit	DPST-1-1
507	SU 1 - Output	Default fan speed	Default object for specifying a certain fan speed (values 0 to 4)	1 byte	DPST-5-100
508	SU 1 - Input	Fan level feedback	Current value of the set fan speed (values 0 to 4)	1 byte	DPST-5-100
509	SU 1 - Output	Preset fan speed (percentage)	Default object for specifying a certain fan speed (values 0 to 100%)	1 byte	DPST-5-1

ID	Name	Object function	Description and release	Length	DPT
510	SU 1 - Input	Fan level feedback (percent)	Current value of the set fan speed (values 0 to 100%)	1 byte	DPST-5-1

511 - 549			See CO 511-549: Objects for SU 2-4		
-----------------	--	--	------------------------------------	--	--

553	Logic 1 - Input	Logic gate input 1	1 bit object as input 1 of a logic gate (1...8). The input status can optionally be inverted. This object is only available if the type of logic function is configured to "Logic gate" and input 1 is used.	1 bit	DPST-1-2
		Converter lock function	1-bit object as an input of a converter. It is configurable whether the converter responds to both ON and OFF commands, or alternatively processes only ON or only OFF telegrams. This object is only available if the type of logic function is configured to "Converter".	1 bit	DPST-1-2
		Lock element lock function	1-bit object as an input of a lock element. This object is only available if the type of logic function is configured to "Lock Element".	1 bit	DPST-1-2
		Comparator input	4-byte object as an input of a comparator. This object is only available if the type of logic function is configured to "Comparator" and the data format is set to "4 Byte Value -2147483648...2147483647 (DPT 13.001)".	4 bytes	DPST-13-1
		Limit value switch input	4-byte object as an input of a limit switch. This object is only available if the type of logic function is configured to "Limit Switch" and the data format is set to "4 Byte Value -2147483648...2147483647 (DPT 13.001)".	4 bytes	DPST-13-1
554	Logic 1 - Input	Logic gate input 2	1 bit object as input 2 of a logic gate (1...8). The input status can optionally be inverted. This object is only available if the type of logic function is configured to "Logic gate" and input 2 is used.	1 bit	DPST-1-2
		Converter input	1 bit object as a lock input of a converter. A locked converter no longer processes input states and, therefore, does not implement any new output values (the last value is retained and may be sent out cyclically if necessary). The telegram polarity can be configured. This object is only available if the type of logic function is configured to "Converter".	1 bit	DPST-1-2
		Lock element input	1 bit object as a lock input of a lock element. A locked lock element no longer passes input states to the filter and, therefore, does not implement any new output values (the last value is retained and may be sent out cyclically if necessary). The telegram polarity can be configured. This object is only available if the type of logic function is configured to "Lock Element".	1 bit	DPST-1-2
555	Logic 1 - Input	Logic gate input 3	1 bit object as input 3 of a logic gate (1...8). The input status can optionally be inverted. This object is only available if the type of logic function is configured to "Logic gate" and input 3 is used.	1 bit	DPST-1-2
556	Logic 1 - Input	Logic gate input 4	1 bit object as input 4 of a logic gate (1...8). The input status can optionally be inverted. This object is only available if the type of logic function is configured to "Logic gate" and input 4 is used.	1 bit	Umsetzer Sperrfunktion
557	Logic 1 - Output	Logic gate output	1 bit object as the output of a logic gate (1...8). This object is only available if the type of logic function is configured to "Logic gate".	1 bit	DPST-1-2
		Converter output	1 byte object as the value output of a converter. This object is only available if the type of logic function is configured to "Converter".	1 byte	DPST-5-1
		Lock element output	1-bit object as an output of a lock element. This object is only available if the type of logic function is configured to "Lock Element".	1 bit	DPST-1-2
		Comparator output	1 bit object as the output of a comparator. The output object is permanently defined as 1 bit (DPT 1.002) and outputs the result of the comparison operation (ON = true / OFF = false). This object is only available if the type of logic function is configured to "Comparator".	1 bit	DPST-1-2

ID	Name	Object function	Description and release	Length	DPT
		Limit value switch output	1 bit object as the output of a limit value switch. The output object is permanently defined as 1 bit (DPT 1.002) and outputs the result of the threshold value evaluation from (ON = true / OFF = false) This object is only available if the type of logic function is configured to "limit value switch".	1 bit	DPST-1-2
558 - 592			See CO 553-557: Objects for Logic 2-8		

Table 2: Communication objects

Technical data

	Premium	Standard
Power consumption	typ. 75 mA at 29 V Type 5.1 connector plug	typ. 45 mA at 29 V Type 5.1 connector plug
Proximity sensor / motion detector	Radar 60 GHz, with 10 modulation frequencies CW, 0 to 100% transmission power adjustable in 8 steps	
Premuim display	320x170 with approx. 0.1nm dots	n.a.
Rocker displays	480x80 with approx. 0.1nm dots	
Rockers	Mechanical	
Connections	2x external temperature/binary inputs: supplied by Enerterx® MeTa² KNX room controller	
Housing	-housing front (depending on the variant): + Anodized solid aluminium + Powder-coated solid aluminium + Gold-plated brass - Plastic rear panel - Housing dimensions: 90 x 161 x 14.6 mm - Suitable for standard flush-mounted box	-housing front (depending on the variant): + Anodized solid aluminium + Powder-coated solid aluminium + Gold-plated brass - Plastic rear panel - Housing dimensions: 90 x 90 x 14.6 mm - Suitable for standard flush-mounted box
General	For use in dry indoor areas only. Ambient temperature: -5 ... +45° C Protection class IP20 Protection class III	
Sensors	Temperature Humidity Luminous intensity	
Acoustic output	Piezo buzzer in two volumes	